

Beta
Beta
Beta



1939
2019

ANNIVERSARY

*Promozione valida
dal 14/01/2019 al 16/12/2019
Prezzi netti I.V.A. esclusa*

Beta

RSC55



Configura on-line
la tua officina

www.rsc55.it

www.youtube.com/

www.betatools.com



Pag

1		1498/40A	60	1928CD	86	561/1	37	7880SC	101	C24SAXL/8	5
111	27	1498/120A	59	1928DA	86	599DGT-AN	37	7900E	101	C24SAXL/9	5
142/SC9I	26	1498LT/12	60	1928K4	85	5904U/MP	19	7903E	104	C24SL-CAB	6
142C/A12	26	1498MN/12	60	1930LA	87	5904VA/T	19	7905E	103	C24SL	6
142SN/SC9	26	1498PC	82	1930LH	87	5914VU/M	15	7907E	104	C27S	12
186	46	1498TB/12-24	59	1930PA	86	5927VU/M	12	7909E	103	C28	7
192/S2	26	1500	44	1930ZL	86	5941VU/M	13	7984G	102	C33/6	4
1009L/DP-S2	38	1529/C7	66	1933I	89	5988U6/MP	18	8		C33/7	4
1031/S4	39	1530/C16	71	1937	87	5988UX/MP	20	860/C27	30	C33/8	4
1047	39	1545/C5M	45	1942A	89	6		860MIX/A10	30	C39-6	4
1048	39	1547/C6	45	1944A	89	605E	36	860MIX/A31	30	C39-7	4
1052	39	1550U	72	1945C	90	666N	36	860PE/A10	30	C39-8	4
1081	39	1550U/M	72	1945P	90	677C	37	860PHZ/A10	30	C41H	13
1128BAX	42	1550U/SS 187	72	1945S	90	7		860TX/A10	30	C51	11
1149F	47	1567	71	1946C4,8	89	720LC/C3	72	862F/A7	30	C55PB-PRO/5	9
1169/D4	38	1606T	47	1947M	91	720S/SB6	84	9		C56	11
1169BM/D3	38	1609B	47	1949GPE	91	7042LCD	50	90/S7	26	C56PO	10
1169MQ/D2	38	1650	43	1972/12	56	7210PB	96	96/SC9	29	C59A	8
1203/D8P	31	1651DGT	43	1972/18	57	7211PG	96	96BPA/SC9	29	C59B	8
1203/D10N	31	1691BM	43	1982/12EF	56	7212FG	95	96BPC/SC9	29	CA49-G	61
1207TX/D7	31	1726	42	1984/18QM	57	7213FG	95	96LBP/SC9	29	CB52-O	68
1256/C36-2	47	1740B	48	2		7214FN	95	96T/S5P	28	CP15	15
1263/D8	31	1741B	48	2028/VV	16	7218FN	95	97BTX/SC8	29	CP15L	15
1263/D10	31	1741U	48	2037/TV	16	7220PEK	93	97BTXL/SC8	29	CP17	14
1267TX/D7	31	1749AC	48	2038/TV	16	7221PEK	93	97TTX/S6	28	CP51	11
1273MQ/D6	31	1750	49	2080/V12	14	7223PEK	93	900/58	32	CX49-G	61
1273MQ/F-D6	31	1750TA	49	2250-O	79	7224PEK	93	900/C12M	33	M	
1293/D8	31	1756C	49	2251-O	79	7236B	94	900/C12MR	33	M10	21
1293INOX/D8	35	1756D	49	2254C	79	7238WR	94	900/C39	33	M30	21
1365/K13	81	1758	65	2254F	80	7241CK	92	900/C39-R	33	M60	21
1366/K5	81	1759HD/3	65	2254SV	80	7243CK	92	902A/C22	33	M63	21
1366/KF	82	1760/RMS	47	2254T	80	7245BK	92	910/58	32	M65	21
1366A	82	1760PA/AC-DC	58	2258-O	80	7246BK	92	910A/C16	34	M100	21
1366S	83	1772M	42	3		7249G	94	910A/C16HR	34	M120	22
1366S-KIT	83	1778U	42	31BM/D6	40	7310CRK	94	920/55L	32	M121	22
1366SL	83	1827F	51	32AU	40	7313B	96	920/58	32	M130	22
1366ST	83	1834PL	52	334	46	7313G	96	920A/C17M	34	M210	22
1367	82	1834PM	52	340	46	7314AB	97	920A/C17MR	34	M230	22
1368	81	1834PS	52	342	46	7314AF	97	920INOX/C16	35	M288	22
1368G/K400	81	1834PXL	52	351C	46	7315AN	97	928A/C12	34	T	
1370T	40	1836A	52	388C/C8	46	7318AN	97	944BX/D6	27	T10	23
1390	40	1837N	52	3002	79	7340B	98	951/S6	28	T15	23
1392	40	1838/11LED	54	3003	79	7340R	98	952/D7	27	T16	23
1428/SB11	45	1838COB	52	3006	74	7340Y	98	960AD/TP2	62	T31	23
1430/S8	44	1838FLASH	53	3009	72	7341N	98	960EPC	64	T40	23
1433/C11	44	1838SLR	53	3010H	75	7398U	99	960KC-M8/9/10	64	T45	23
1438K/DSG	68	1842LED/ABM	54	3010V	75	7421	99	960KPC	64	T46	23
1464AP	62	1846LED/BM	54	3025	75	7423	99	960PI/C19	65	T50	23
1464APB	63	1848	54	3025/PF	75	7425	99	961D	58	T55	23
1464FG	62	1852R1750	51	3026	78	7427	99	962M	73	T63	23
1464IC	63	1860 160A	50	3026/SP	78	7429	99	962P	73	T83	23
1464PB	62	1860SQ	51	3027	78	7525	102	986PT	73	T85	23
1464PF	63	1870	55	3030/2T	76	7526	102	987AR	73	T91	23
1464PT	63	1871M	55	3035	74	7683	102	9899C 1/4	20	T92	23
1464T	62	1877	70	3065	76	7780T	102	C		T103	24
1464TDI	63	1877A	70	3067	77	7811	102	C04TSS/7	7	T131	24
1466/C5	70	1884	68	4		7816BL	101	C5	17	T145	24
1471M/C22	71	1889CF	70	42/S17X	25	7816G	101	C6T	17	T153	24
1472FC/GE	65	1895	67	42/S26	25	7830ST	104	C7	17	T199	24
1485BPM	66	1901BM/8	91	42/SC9I	25	7833ST	100	C8	17	T202	24
1485FCA/K2	67	1901T/10	91	42/SP15	25	7835ST	103	C10	17	T205	24
1485FRD/T	66	1922P1	88	42/INOX/SC9	35	7840BL	100	C10S	17	T210	24
1485MTJ/1.3	66	1922P2	88	412/SP19P	41	7860E	100	C11	17	T212	24
1485PMTJ	66	1922P3	88	415CO/SP19A	41	7863E	104	C14	15	T215	24
1493/C7	69	1924F	88	420/A3	41	7865E	103	C20L	14	T234	24
1493X	69	1927B	84	426MD-3/A9	41	7867E	104	C20TSS	14	T236	24
1493Y	69	1927CD/K3	85	437U/09	41	7869E	103	C24S/6	5	T239	24
1498/24	60	1927G	84	446/C110	41	7870E	100	C24S/7	5		
1498/8A	58	1927P	85	5		7873E	104	C24S/8	5		
1498/30A	58	1927XM/K5	84	55/SP13	26	7875E	103	C24SAXL/7	5		

Una soluzione per ogni esigenza...



Qualità certificata.

Le nostre cassettiere hanno superato con successo i 31 test costruttivi previsti dal TÜV, ottenendo l'ambita certificazione di qualità.



C39

4



C33

4

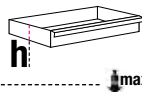
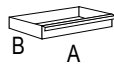
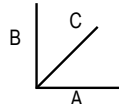

30 kg	4 x h 70 mm	5 x h 70 mm	6 x h 70 mm	4 x h 75 mm	5 x h 75 mm	6 x h 75 mm
35 kg	1 x h 140 mm	1 x h 140 mm	2 x h 140 mm	1 x h 150 mm	1 x h 150 mm	2 x h 150 mm
35 kg	1 x h 280 mm	1 x h 210 mm	-	1 x h 305 mm	1 x h 225 mm	-



800 x 971 x 500 mm

807 x 1016 x 500 mm

6
59 kg

7
61 kg

8
64 kg

6
69 kg

7
71 kg

8
73 kg

588 x 367 mm

588 x 367 mm

6

7

8

6

7

8

abbina il tuo assortimento

5988U6/MP (214) 18			✓			✓
5904U/MP (91) 19	✓	✓	✓	✓	✓	✓
5904VA/T (102) 19	✓	✓	✓	✓	✓	✓
5988UX/MP (135) 20						

Scegli la cassettera che fa al caso tuo!

kg
800



C24S

5

kg
1100



C24SL-CAB

6

kg
1100



C24SL

6

kg
1000



C24SA-XL

5



RAL 2011

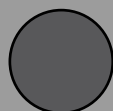

RAL 7016



RAL 3000



740 x 955 x 445 mm

1050 x 973 x 565 mm

1050 x 973 x 565 mm

1035 x 970 x 445 mm

6 55 kg	7 58 kg	8 61 kg
------------	------------	------------

82 kg

80 kg

7 84 kg	8 88 kg	9 92 kg
------------	------------	------------

588 x 367 mm

588 x 367 mm

588 x 367 mm

882 x 367 mm

6	7	8
---	---	---

7

7

7	8	9
---	---	---

4 x h 70 mm	5 x h 70 mm	6 x h 70 mm
1 x h 140 mm	1 x h 140 mm	2 x h 140 mm
1 x h 280 mm	1 x h 210 mm	-

5 x h 70 mm
1 x h 140 mm
1 x h 210 mm

5 x h 70 mm
1 x h 140 mm
1 x h 210 mm

5 x h 70 mm	6 x h 70 mm	8 x h 70 mm
1 x h 140 mm	2 x h 140 mm	1 x h 140 mm
1 x h 210 mm	-	-



C39

Aluminium ^{AL}

Cassettiera mobile

- Quattro ruote con nucleo in acciaio Ø 125 mm: 2 fisse e 2 girevoli (una con freno).
- Serratura di sicurezza centralizzata frontale.

**Struttura portante in lega di alluminio
+ RESISTENZA + LEGGEREZZA**

Portacarta e portafilaconi laterali e posteriori.

Cassetto ad estrazione totale con sistema di apertura posizionato su tutta la lunghezza del cassetto.

Piano di lavoro multifunzione ad alta resistenza con portaminuterie e fori per l'alloggiamento dei giravite.



C39/6	039000031	039000032	039000033	€ 1.260,00	€ 705,00
C39/7	039000001	039000002	039000003	€ 1.335,00	€ 750,00
C39/8	039000041	039000042	039000043	€ 1.420,00	€ 795,00



C33

Cassettiera mobile

con cassette da 588x367 mm montati su guide telescopiche a sfera.

- Quattro ruote con nucleo in acciaio Ø 125 mm: 2 fisse e 2 girevoli (una con freno).
- Serratura di sicurezza centralizzata frontale.

Più alta, più robusta, più sicura!

Paracolpi angolari su tutta l'altezza della cassettiera per evitare, in caso di urto, il danneggiamento dei veicoli all'interno dell'officina.



Cassetto ad estrazione totale con sistema a sgancio rapido in nylon rinforzato con fibra di vetro e possibilità di apertura su tutta la lunghezza del cassetto.



Pratica scanalatura a "V" per la lavorazione di tubi o profilati.

Piano di lavoro multifunzione ad alta resistenza con portaminuterie e fori per l'alloggiamento dei giravite.

Portafilaconi e portacarta laterali integrati regolabili in più posizioni.



C33/6	033000261	033000262	033000263	€ 855,00	€ 495,00
C33/7	033000271	033000272	033000273	€ 915,00	€ 530,00
C33/8	033000281	033000282	033000283	€ 975,00	€ 565,00



C24S

Cassettiera mobile

- Quattro ruote con nucleo in acciaio Ø 125 mm: 2 fisse e 2 girevoli (una con freno).
- Serratura di sicurezza centralizzata.
- Possibilità di applicazione del portacarta 2400S-R/PC (da ordinare separatamente).



Piano di lavoro in ABS ad alta resistenza



Cassetto ad estrazione totale con sistema di apertura in nylon rinforzato in fibra di vetro posizionato su tutta la lunghezza del cassetto.



C24S/6	024002061	024002062	024002063	€ 715,00	€ 407,00
C24S/7	024002071	024002072	024002073	€ 775,00	€ 442,00
C24S/8	024002081	024002082	024002083	€ 835,00	€ 479,00

Portaflaconi laterale integrato.



C24SA-XL

Cassettiera mobile con sistema antiribaltamento, modello lungo

- Quattro ruote con nucleo in acciaio Ø 125 mm: 2 fisse e 2 girevoli (una con freno).
- Serratura di sicurezza centralizzata frontale.
- Possibilità di applicazione del portacarta 2400S-R/PC (da ordinare separatamente).

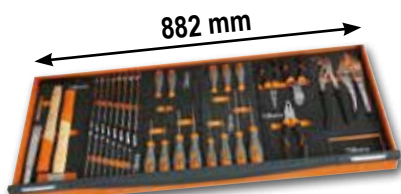

può contenere 6 moduli

Cassetto ad estrazione totale con sistema di apertura in nylon rinforzato in fibra di vetro posizionato su tutta la lunghezza del cassetto con porta-etichette integrato.

Portaflaconi laterale integrato.

Sistema antiribaltamento



C24SA-XL/7	024002271	024002272	024002273	€ 1.035,00	€ 593,00
C24SA-XL/8	024002281	024002282	024002283	€ 1.110,00	€ 637,00
C24SA-XL/9	024002331	024002332	024002333	€ 1.175,00	€ 680,00



C24SL-CAB

Cassettiera mobile con 7 cassetti e armadietto porta-oggetti

- Quattro ruote con nucleo in acciaio Ø 125 mm: 2 fisse e 2 girevoli (una con freno).
- Serratura centralizzata frontale.
- Portacarta integrato.



Armadietto laterale portaoggetti con ripiano interno regolabile in altezza e anta richiudibile con serratura.



Doppio portaflaconi posteriore.



024002191	024002192	024002193	€ 1.185,00	€ 683,00
-----------	-----------	-----------	-----------------------	-----------------

Piano di lavoro in legno multistrato con fori per la collocazione di una morsa 1599F/100 (da ordinare separatamente).



C24SL

Cassettiera mobile con 7 cassetti e ripiani laterali

- 7 cassetti da 588x367 mm, montati su guide telescopiche a sfera.
- 3 portaflaconi e portacarta integrati.
- Vano laterale con ripiano regolabile in altezza.
- Serratura di sicurezza centralizzata frontale.
- 4 ruote Ø 125 mm: 2 fisse e 2 girevoli (2 con freno).
- Piano dei cassetti protetto da tappetini di gomma espansa 1599F/100 da ordinare separatamente.



024002101	024002102	024002103	€ 1.150,00	€ 665,00
-----------	-----------	-----------	-----------------------	-----------------

Piano di lavoro in legno multistrato con fori per la collocazione di una morsa 1599F/100 (da ordinare separatamente).



C28

Carrello SuperTank con piano di lavoro e 10 cassetti

- Cinque cassetti laterali e cinque cassetti frontali.
- Quattro ruote con nucleo in acciaio Ø 125 mm: 2 fisse e 2 girevoli con freno).
- 2 serrature di sicurezza centralizzate.
- 4 portaflaconi: 2 frontali e 2 posteriori.
- 6 vaschette portaminuterie laterali.
- Vano passante altezza 135 mm con base ricoperta in materiale plastico.



Sistema rapido e sicuro per l'apertura e chiusura dei cassetti con frontalino in nylon e fibra di vetro.



Vano laterale con antina di chiusura a scomparsa con serratura.



028000301 028000302 028000303 130 kg ~~€ 2.045,00~~ € 1.177,00

Piano di lavoro in legno multistrato con fori per la collocazione di una morsa 1599F/150 (da ordinare separatamente).

n°	h	↓ max
8	70 mm	25 kg
2	210 mm	30 kg

Kg
1200



C04TSS/7

Cassettiera mobile con 7 cassetti completamente in acciaio inossidabile

- Sette cassetti da 570 x 410 mm montati su guide telescopiche a sfera; 6 cassetti altezza 83 mm; 1 cassetto altezza 170 mm.
- quattro ruote con nucleo in acciaio inossidabile Ø 125mm 2 fisse e 2 girevoli (due con freno).
- Serratura frontale centralizzata.
- Struttura interamente in acciaio inossidabile AISI 304.
- Ruote, supporti, sfere, interno dei cassetti e relative guide in acciaio inossidabile.
- Maniglia cassetti in alluminio.

Kg
700

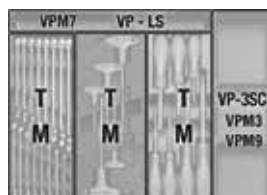

n°	h	↓ max
6	83 mm	25 kg
1	170 mm	30 kg

024003077 63 kg

~~€ 2.085,00~~ € 1.198,00

Banchi da lavoro "Endurance"



- Ripiano in legno multistrato con fori per la collocazione di una morsa 1599F/125 (da ordinare separatamente).
- Piano dei cassetti protetto da tappetini di gomma espansa.
- Cassettiere predisposte per l'inserimento di termoformati
- Frontalino dei cassetti in nylon ad alta resistenza
- Serratura di sicurezza centralizzata frontale.
- Ripiano inferiore portaoggetti.
- Predisposizione per portacarta (2400S-R/PC) e portafaconi (2400S/PF) da ordinare separatamente.



C59A

Banco con 1 cassettiera da 6 cassetti

- 6 cassetti 588x367 mm, montati su guide telescopiche a sfera.

n°	h	max
4	70 mm	25 kg
1	140 mm	30 kg
1	280 mm	35 kg



059000001	059000021	059000041	115 kg	€ 1.320,00	€ 755,00
-----------	-----------	-----------	--------	-----------------------	-----------------



C59B

Banco con 2 cassettiere da 6 cassetti

- 12 cassetti 588x367 mm, montati su guide telescopiche a sfera

n°	h	max
8	70 mm	25 kg
2	140 mm	30 kg
2	280 mm	35 kg



059000002	059000022	059000042	155 kg	€ 1.760,00	€ 1.015,00
-----------	-----------	-----------	--------	-----------------------	-------------------



C55PB-PRO/5

Postazione di lavoro per arredo officina composta da:

C55B-PRO

- Banco con piano da lavoro 2050x700 mm rivestito da uno strato di PVC antiurto e antigraffio resistente agli idrocarburi
- Fori per la collocazione di una morsa 1599F/150 (da ordinare separatamente)
 - Piedini regolabili in altezza

C55C7

- Cassettiera mobile con 7 cassetti da 588x367 mm, montati su guide telescopiche a sfera
- 4 ruote Ø 100 mm, 2 fisse (una con freno) e 2 girevoli
 - Piano dei cassetti protetto da tappetini di gomma espansa
 - Serratura centralizzata frontale

C55M7

- Modulo fisso con 7 cassetti da 588x367 mm, montati su guide telescopiche a sfera
- Piano dei cassetti protetto da tappetini di gomma espansa
 - Serratura centralizzata frontale

C55PSP

- Parete portautensili con tapparella e struttura portante
- Tapparella in alluminio, manovrabile verticalmente, con serratura
 - Pannello forato amovibile per il sostegno degli utensili



C55PSP

C55M7

C55C7

C55B-PRO



Predisposizione per l'inserimento dei termoformati.



La cassettiera C55C7 è facilmente estraibile da parte dell'operatore grazie alle ruote girevoli.



Presa per aria compressa con arrotolatore da Ø 8 mm. Lunghezza: 10 m



Presa Schuko+16+10A
Presa EU Plug 16+10A

055000025 246 kg

€ 6.210,00 € 3.600,00



C56PO

Banco da lavoro pieghevole

- Piano di lavoro spessore 30 mm in MDF e lamiera zincata utilizzabile da entrambi i lati.
- Maniglia con protezione in gomma per un agevole trasporto.
- Piedini con copertura anti-scivolamento.

Novità

*Compatto
e facilmente
TRASPORTABILE*



056000011 26 kg

~~€ 340,00~~ € 199,00

C56

Banco da lavoro

- Piano di lavoro in lamiera verniciata con bordo perimetrale
- Struttura in acciaio con 6 gambe di sostegno
- Due cassetti dotati di serratura
- Predisposizione per il fissaggio al pavimento



056000201	056000202	056000203	82 kg	€ 745,00 € 425,00
-----------	-----------	-----------	-------	------------------------------



C51

Carrello

- 3 ripiani ricoperti in gomma millerighe antiscivolo
- Doppia possibilità di fissaggio del ripiano centrale
- Quattro ruote Ø 100 mm: 2 fisse e 2 girevoli (una con freno)



051000001	051000002	051000003	21 kg	€ 210,00 € 119,00
-----------	-----------	-----------	-------	------------------------------

CP51

Carrello ad alta resistenza

- 2 ripiani ricoperti da tappetini in gomma
- Quattro ruote Ø 125 mm ad alta resistenza: 2 fisse e 2 girevoli con freno



051000501	051000502	051000503	37 kg	€ 275,00 € 158,00
-----------	-----------	-----------	-------	------------------------------

C27S

Carrello portautensili richiudibile per interventi esterni, vuoto

- Struttura in lamiera.
- Carrello richiudibile con colonnine ribaltabili per permettere un agevole trasporto.
- 2 cassette 588x277 mm montati su guide telescopiche che permettono l'apertura in due sensi.
- Ampio vano portaoggetti inferiore 588x277x220 mm.
- 2 ruote fisse Ø 160 mm e 2 ruote piroettanti con freno Ø 100 mm.
- Piano di lavoro termoplastico con 6 vaschette portaminuterie integrate.
- Chiusura centralizzata.
- Predisposizione per l'alloggiamento di separatori per cassetto e termoformati portautensili MC.



027000201	027000202	027000203	20 kg	€ 540,00 € 309,00
-----------	-----------	-----------	-------	------------------------------



n°	h	max
2	70 mm	20 kg



5927VU/M



**SOFT
MODULE
SYSTEM**

Assortimento di 108 utensili in termoformato morbido per carrello C27S



34 MC10



74 MC20

per cassetto: 588x277 mm

059270021 8,3 kg

~~€ 817,00~~ € 472,00



C41H

Trolley portautensili a 2 moduli sovrapponibili

- Struttura in lamiera e in materiale plastico: grande robustezza e peso ridotto.
- 2 moduli separabili: 1 cestello superiore, 1 modulo con 2 cassetti altezza 95 mm, 1 cassetta estraibile in materiale plastico altezza 66 mm e 1 cassetto altezza 295 mm.
- Ruote di grosso diametro 160 mm integrate nella struttura per facilitare il trasporto anche su gradini.
- Serratura centralizzata laterale per la chiusura dei cassetti del modulo inferiore.
- Cassetti montati su guide telescopiche a sfera con doppio gancio di chiusura.
- Impugnatura con manico telescopico in alluminio.
- Portaminuterie integrato.
- Cassetto inferiore con doppia guida telescopica.



C41H W
RAL 9016

C41H Y
RAL 1023

C41H R
RAL 3000

C41H V
RAL 6024

C41H B
RAL 5002

C41H G
RAL 7016

C41H N
RAL 9005

21 kg

041000002 041000021 041000012 041000008
041000024 041000006 041000010 041000005

€ 455,00 € 256,00



Novità

**SOFT
MODULE
SYSTEM**

5941VU/M



Assortimento di 64 utensili per trolley C41H, in termoformato morbido



MC21

MC11

N. pezzi/Descrizione

- 16 chiavi combinate 6-7-8-9-10-11-12-13-14-15-16-17-18-19-21-22 mm
- 9 chiavi maschio esagonale piegate ○
- 1 flessometro 5 m
- 19 chiavi a bussola esagonali 1/2" ○ 10-11-12-13-14-15-16-17-18-19-20-21-22-23-24-26-27-30-32 mm
- 1 snodo 1/2"
- 1 quadro maschio 1/2" con spina scorrevole
- 1 cricchetto reversibile 1/2" ⊗
- 2 prolunga angolare - 1/2" 125-250 mm

Beta N.	TR
42	MC11
96/SC9	MC11
1692/5	MC11
920A	MC21
920/25	MC21
920/42	MC21
920/55	MC21
920AN	MC21

N. pezzi/Descrizione

- 1 chiave regolabile a rullino 250 mm
- 1 pinze regolabili cerniera chiusa 250 mm
- 1 tronchesi a taglienti diagonali 160 mm
- 1 forbici per elettricisti lame diritte 145 mm
- 1 pinza universale 180 mm
- 1 pinza a becchi mezzotondi diritti 160 mm
- 3 giravite lama piatta 3,5x100-5,5x125-6,5x150 mm
- 3 giravite per viti con impronta a croce Phillips® PH0-PH1-PH2
- 1 martello tipo tedesco 300 g
- 1 cutter con lama a settori 18 mm

Beta N.
111
1048
1082BM
1128BMX
1150BM
1166BM
1260
1262
1370
1771

059410001 9,2 kg

€ 719,00 € 417,00

C20L

Cestello estendibile a 5 scomparti in lamiera, vuoto

021200002 5,4 kg

~~€ 65,50~~ € 37,50

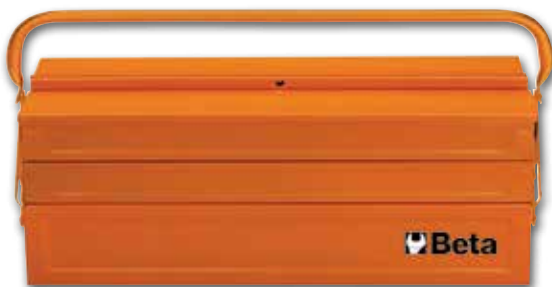

550x200x210 mm

C20TSS

Cestello estendibile a 5 scomparti in acciaio inossidabile AISI 304 può essere utilizzato in ambienti critici, ovvero zone e aree in cui non è ammesso il livello minimo di contaminazione, resiste alla ruggine e ai principali acidi ed è sterilizzabile in autoclave a 121 °C.



021203001 4 kg

~~€ 235,00~~ € 138,00



450x200x210 mm

Novità

- *Industria alimentare,*
- *Produzione farmaceutica – classe C,*
- *Applicazioni marine,*
- *Laboratori biotecnologici e biomedici.*

CP17

Cestello portautensili in acciaio inox e materiale plastico con contenitore asportabile, vuoto



500x200x220 mm

021170500 2,5 kg

~~€ 68,00~~ € 39,50



2080/V12

Valigia organizer con 12 vaschette asportabili

Vaschette portaminuterie asportabili, richiudibili e trasparenti per un' immediata riconoscibilità del contenuto.



020800000 1,8 kg

~~€ 46,00~~ € 26,50

300x330x145 mm

Cestelli in materiale plastico con contenitori e vaschette portaminuterie, vuoti

CP15L



558x277x270 mm

021150202 2,5 kg

~~€ 49,50~~ € 28,50

- 3 vaschette portaminuterie integrate nel coperchio con divisori regolabili
- 1 contenitore interno con divisori regolabili
- Capacità di carico: 30 kg



CP15



445x240x250 mm

021150201 2 kg

~~€ 37,00~~ € 21,30

C14

Trolley portautensili in polipropilene con 4 cassetti, vuoto

- Struttura in polipropilene a iniezione che garantisce elevata resistenza agli urti
- 4 robuste ruote posteriori
- 3 vaschette porta minuteria incluse
- Targhetta identificativa portanome
- Predisposizione per la chiusura con lucchetto TSA
- Ruote di grosso diametro (ø 160 mm)

Vassoio superiore removibile



580x380x455 mm

La parte anteriore, protetta dal coperchio frontale, ospita 4 cassetti estraibili:

- 1 cassetto altezza 30 mm
- 2 cassetti altezza 60 mm
- 1 cassetto altezza 90 mm



La serratura centralizzata frontale consente di chiudere contemporaneamente i due coperchi, quello superiore e quello frontale



Due maniglie laterali

021140000 10 kg

~~€ 662,00~~ € 384,00

5914VU/M



Assortimento di 109 utensili per trolley C14, in termoformato morbido



MC T1



MC T2



MC T3

* per l'utilizzo in abbinamento con il trolley C14, occorre rimuovere il pannello portautensili superiore

059140109 8,5 kg

~~€ 895,00~~ € 517,00

* solo assortimento

2037/TV

Trolley portautensili in polipropilene ad alto spessore con 4 ruote pivotanti, vuoto

- Estremamente resistente agli urti. Indicato per il trasporto di utensili in aereo
- 2 vaschette portaminuterie incluse
- Maniglia ergonomica rivestita in gomma
- Tasca porta documenti
- 4 ruote pivotanti
- 2 pannelli portautensili removibili che consentono la movimentazione orizzontale del trolley



2 pannelli portautensili removibili



2 serrature omologate TSA con chiave



020370000 7 kg

~~€ 505,00~~ € 291,00

420x325x275 mm

2038/TV

Trolley portautensili in polipropilene ad alto spessore, vuoto

- Estremamente resistente agli urti
- Profilo di tenuta in alluminio
- Maniglione telescopico e grandi ruote con cuscinetti a sfera
- Fondo capiente
- Tasca porta documenti
- 3 cassettoni portaminuterie



2 pannelli portautensili removibili



2 maniglie (1 laterale) ergonomiche rivestite in gomma



2 serrature omologate TSA con chiave



020380000 9 kg

~~€ 670,00~~ € 389,00

430x500x340 mm

2028/VV

Valigia portautensili in polipropilene, vuota

- 2 pannelli portautensili
- Fondo interno con divisori removibili
- Doppia chiusura con combinazione



020280010 4,5 kg

~~€ 190,00~~ € 111,50



470x185x410 mm

Novità



Borse portautensili in tessuto tecnico leggera e altamente resistenti per trasportare in totale sicurezza e comodità i tuoi utensili

C5

Zaino, vuoto

- Pannello portautensili interno removibile
- 6 tasche esterne e 2 tasche interne
- Base in materiale plastico resistente all'acqua
- Doppio laccetto di sicurezza per fissare lo zaino sulle spalle
- Schienale ergonomico imbottito



021050000 2,5 kg

~~€ 120,00~~ € 69,00

500x400x180 mm

C6T

Zaino con ruote, vuoto

- Manico telescopico di trasporto
- Ruote integrate nella struttura con copertura anti-polvere per l'impiego come zaino
- 2 pannelli portautensili removibili
- Tasca per PC interna e 5 tasche esterne
- Base in materiale plastico resistente all'acqua



021060010 4,5 kg

~~€ 172,00~~ € 99,00

480x370x220 mm

C7

Borsa, vuota

- 2 pannelli interni portautensili removibili
- 2 tasche esterne frontali
- Fondo interno in materiale plastico con divisori removibili



021070000 3,5 kg

~~€ 180,00~~ € 104,00

440x370x170 mm

C11

Cestello, vuoto

- Base rigida in materiale plastico resistente all'acqua
- Elastici e tasche portautensili sia interne che esterne
- Buste portadocumenti integrate nel doppio fondo del coperchio



021110000 2 kg

~~€ 72,00~~ € 41,50

400x240x220 mm

C8

Trolley, vuoto

- Manico telescopico di trasporto
- 2 pannelli interni portautensili removibili
- Tasca porta PC interna e 2 tasche esterne frontali
- Predisposizione per l'alloggiamento del cestello C10S



021080000 4 kg

~~€ 202,00~~ € 116,50

470x370x280 mm

Cestello, vuoto

- Struttura rigida • Doppio fondo
- Manico inclinabile per facilitare l'accesso agli utensili
- Elastici portautensili e tasche sia interne che esterne
- Fodero di copertura
- Vaschetta portaminuterie inclusa nel doppio fondo
- Predisposizione per essere utilizzata con il trolley C8



C10S

420x220x250 mm

021100001 2,3 kg

~~€ 95,00~~ € 54,50

C10

520x220x250 mm

021100000 3,3 kg

~~€ 121,00~~ € 69,50

5988U6/MP



consigliato in abbinamento con le cassettiere:
C24S-C24SL-C33-C39-C28-C24SLCAB-C59

Assortimento di 214 utensili
in termoformato morbido



M10

22



M30

31



M210

25



M230

25



M130

13

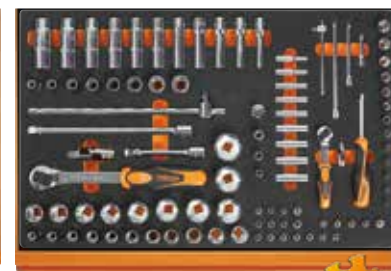

M100

98

N. pezzi/Descrizione

22	chiavi combinate 6-7-8-9-10-11-12-13-14-15-16-17-18-19-20-21-22-24-27-30-32-36 mm	42
11	chiavi a forchetta 6x7-8x9-10x11-12x13-14x15-16x17-18x19-20x22-21x23-24x27-30x32 mm	55
11	chiavi poligonali curve 6x7-8x9-10x11-12x13-14x15-16x17-18x19-20x22-21x23-24x27-30x32 mm	90
9	chiavi maschio esagonale piegate con estremità sferica Ø 1,5-2-2,5-3-4-5-6-8-10 mm	96BPC/SC9
6	giravite lama piatta 2,5x50-3x75-4x100-5,5x125-6,5x150-8x200 mm	1201
1	giravite per viti a testa con intaglio 4x30 mm	1201N
4	giravite Phillips® PH0x60-PH1x80-PH2x100-PH3x150 mm	1202
1	giravite Phillips® PH1x30 mm	1202N
12	chiavi maschio con impugnatura per viti con impronta Torx® T6-T7-T8-T9-T10-T15-T20-T25-T27-T30-T40-T45	1207TX
1	giravite cercafase	1253
3	punzoni Ø 2-3-4 mm	30
6	cacciaspina Ø 2-3-4-5-6-8 mm	31
1	bulino Ø 4 mm	32
1	scalpelli piatti 150 mm	34
2	scalpelli piatti nervati 200-250 mm	35
1	ugnetti 125 mm	36
1	martello tipo tedesco 500 g	1370
1	mazzuola con battenti in materiale plastico Ø 35 mm	1390
1	flessometro 3 m	1692
1	magnete telescopico con testa flessibile	1712TF
1	lima 200 mm	1719BMA...Q
1	lima 200 mm	1719BMA...T
1	lima 200 mm	1719BMA...P
1	lima 200 mm	1719BMA...M
1	lima 200 mm	1719BMA...R
1	spazzola fili d'acciaio	1737NX
1	cutter con lama a settori 18 mm	1771
1	pinze becchi dritti per anelli elastici, per fori Ø 180 mm	1032
1	pinze becchi piegati per anelli elastici, per fori Ø 170 mm	1034
1	pinze becchi dritti per anelli elastici, per alberi Ø 175 mm	1036

N. pezzi/Descrizione

1	pinze becchi piegati per anelli elastici, per alberi Ø 175 mm	1038
1	pinze regolabili cerniera chiusa 250 mm	1048
1	pinza autobloccante 240 mm	1052
1	tronchesi a taglienti diagonali 160 mm	1082BM
1	tenaglie per cementisti 220 mm	1098
1	cesoia a lame larghe diritte 250 mm	1112
1	forbici per elettricisti lame dritte	1128BM
1	pinza universale 180 mm	1150BM
1	pinza a becchi mezzotondi dritti 160 mm	1166BM
1	pinza a becchi mezzotondi piegati 160 mm	1168BM
1	bussola portainseri	895/1
1	bussola portainseri	895/3
1	bussola portainseri	895/6
13	chiavi a bussola esagonali 1/4" Ø 4-4,5-5-5,5-6-7-8-9-10-11-12-13-14 mm	900
9	chiavi a bussola a mano lunghe bocca esagonale Ø 5-6-7-8-9-10-11-12-13 mm	900L
5	chiavi a bussola maschio esagonale 1/4" Ø 3-4-5-6-7 mm	900ME
4	chiavi a bussola a giravite per viti con intaglio Ø 0,8x4-1x5,5-1,2x6,5-1,2x8 mm	900LP
4	chiavi a bussola a giravite per viti con impronta a croce Phillips® PH1-PH2-PH3-PH4	900PH
7	chiavi a bussola a giravite maschio per viti con impronta Torx® T10-T15-T20-T25-T27-T30-T40	900TX
1	prolunga - 1/4" 50 mm	900/20
1	prolunga - 1/4" 100 mm	900/20L
1	prolunga - 1/4" 150 mm	900/21
1	snodo 1/4"	900/25
1	quadro con impugnatura 1/4"	900BG/30
1	quadro scorrevole 1/4"	900/42
1	cricchetto reversibile 1/4" ®	900/55
21	chiavi a bussola esagonali 1/2" Ø 8-10-11-12-13-14-15-16-17-18-19-20-21-22-23-24-26-27-28-30-32 mm	920A
1	raccordo con attacco quadro 125 mm	920/15
1	snodo 1/2" 250 mm	920/25
1	prolunga angolare - 1/2"	920AN/125
1	prolunga angolare - 1/2"	920AN/250
1	quadro maschio 1/2" con spina scorrevole	920/42
1	cricchetto reversibile 1/2" ®	920/55
8	chiavi a bussola 1/2" per viti con teste a profilo Torx® Ø 10-12-14-16-18-20-22-24 mm	920FTX
11	chiavi a bussola a mano lunghe bocca esagonale Ø 10-12-13-14-15-16-17-18-19-21-22 mm	920AL

059880535 24 kg

€ 2.530,00 € 1.455,00



5904U/MP

SOFT
MODULE
SYSTEMAssortimento di 91 utensili
in termoformato morbidoconsigliato in abbinamento con le cassettiere:
C24S-C24SL-C33-C39-C28-C24SLCAB-C59

N. pezzi/Descrizione

N. pezzi/Descrizione	Beta N.
16 chiavi combinate 6÷21 mm	42
8 chiavi a forchetta 6x7 - 8x9 - 10x11 - 12x13 - 14x15 - 16x17 - 18x19 - 20x22 mm	55
9 chiavi maschio esagonale piegate \odot 1,5 - 2 - 2,5 - 3 - 4 - 5 - 6 - 8 - 10 mm	96/SC9
7 giravite lama piatta \bullet 2,5x50 - 3x75 - 3,5x100 - 4x125 - 5,5x100 - 5,5x150 - 6,5x150 mm	1260
6 giravite per viti con impronta a croce Phillips® \oplus PH0x60 - PH0x100 - PH1x80 - PH1x120 - PH2x100 - PH2x150 mm	1262
8 chiavi maschio esagonale con impugnatura \odot 2-2,5-3-4-5-6-7-8 mm	96T
1 prolunga angolare - 1/2" 125 mm	920AN/125
1 prolunga angolare - 1/2" 250 mm	920AN/250
1 snodo 1/2"	920/25
1 quadro maschio 1/2" con spina scorrevole	920/42

N. pezzi/Descrizione

N. pezzi/Descrizione	Beta N.
1 cricchetto reversibile 1/2" \oplus	920/55
19 chiavi a bussola esagonali 1/2" \odot 10÷24 - 26 - 27 - 30 - 32 mm	920A
1 tronchesi a grande effetto taglienti diagonali ∇ 160 mm	1084
1 pinza universale \equiv 180 mm	1150
1 pinza a becchi mezzotondi dritti \bullet 160 mm	1166
1 pinze regolabili cerniera chiusa 250 mm	1048
1 pinza autobloccante 240 mm	1052
2 scalpelli piatti nervati 100 - 200 mm	35
1 martello tipo tedesco 300 g	1370
1 mazzuola con battenti in materiale plastico \varnothing 35 mm	1390
1 pinze becchi dritti per anelli elastici, per fori \odot 180 mm	1032
1 pinze becchi piegati per anelli elastici, per fori \odot 170 mm	1034
1 pinze becchi dritti per anelli elastici, per alberi \bullet 175 mm	1036
1 pinze becchi piegati per anelli elastici, per alberi \bullet 175 mm	1038

059040425 12 kg

€ 1.075,00 € 620,00



5904VA/T

Assortimento di 102 utensili
in termoformato rigidoconsigliato in abbinamento con le cassettiere:
C24S-C24SL-C33-C39-C28-C24SLCAB-C59

N. pezzi/Descrizione

N. pezzi/Descrizione	Beta N.
21 chiavi combinate 6-7-8-9-10-11-12-13-14-15-16-17 - 18-19-20-21-22-24-27-30-32 mm	42
8 chiavi a forchetta 6x7-8x9-10x11-12x13-14x15 - 16x17-18x19-20x22 mm	55
9 chiavi maschio esagonale piegate \odot 1,5÷10 mm	96/SC9
6 chiavi maschio esagonale con impugnatura \odot 2-2,5-3-4-5-6 mm	96T
8 chiavi a T con bussola snodata \odot 7-8-10-12-13-14-17-19 mm	952
19 chiavi a bussola esagonali 1/2" \odot 10-11-12-13-14-15-16-17-18-19 - 20-21-22-23-24-26-27-30-32 mm	920A
1 prolunga - 1/2" 125 mm	920/21
1 prolunga - 1/2" 255 mm	920/22
1 snodo 1/2"	920/25
1 quadro maschio 1/2" con spina scorrevole 305 mm	920/42
1 cricchetto reversibile 1/2" \oplus	920/55
1 tronchesi a grande effetto taglienti diagonali ∇ 160 mm	1084BM

N. pezzi/Descrizione

N. pezzi/Descrizione	Beta N.
1 pinza universale \equiv 180 mm	1150BM
1 pinza a becchi mezzotondi dritti \bullet 160 mm	1166BM
1 pinze becchi dritti per anelli elastici, per fori \odot 180 mm	1032
1 pinze becchi piegati per anelli elastici, per fori \odot 170 mm	1034
1 pinze becchi dritti per anelli elastici, per alberi \bullet 175 mm	1036
1 pinze becchi piegati per anelli elastici, per alberi \bullet 175 mm	1038
1 pinza autobloccante 240 mm	1052
1 pinze regolabili cerniera chiusa 250 mm	1048
7 giravite lama piatta \bullet 2,5x50 - 3x75 - 3,5x100 - 4x125 - 5,5x100 - 5,5x150 - 6,5x150 mm	1260
6 giravite per viti con impronta a croce Phillips® \oplus PH0x60 - PH0x100 - PH1x80 - PH1x120 - PH2x100 - PH2x150 mm	1262
2 scalpelli piatti nervati 100-200 mm	35
1 martello tipo tedesco 300 g	1370
1 mazzuola con battenti in materiale plastico \varnothing 35 mm	1390
termoformato vuoto	VP5

059040415 17 kg

€ 1.410,00 € 810,00



5988UX/MP



Assortimento di 135 utensili in termoformato morbido



M50 M15 M33 M145 M131



M16 M55 M153 M199 M202



M234 M236 M83 M289 M91

059880545 20,5 kg

€ 1.600,00 € 920,00



N. pezzi/Descrizione	Beta N.
16 chiavi combinate 6÷21 mm	42
8 chiavi a forchetta 6x7 - 8x9 - 10x11 - 12x13 - 14x15 - 16x17 - 18x19 - 20x22 mm	55
9 chiavi maschio esagonale piegate \odot 1,5 - 2 - 2,5 - 3 - 4 - 5 - 6 - 8 - 10 mm	96/SC9
7 giravite lama piatta \bullet 2,5x50 - 3x75 - 3,5x100 - 4x125 - 5,5x100 - 5,5x150 - 6,5x150 mm	1260
6 giravite per viti con impronta a croce Phillips® \oplus PH0x60 - PH0x100 - PH1x80 - PH1x120 - PH2x100 - PH2x150 mm	1262
8 chiavi maschio esagonale con impugnatura \odot 2-2,5-3-4-5-6-7-8 mm	96T
1 prolunga angolare - 1/2" 125 mm	920AN/125
1 prolunga angolare - 1/2" 250 mm	920AN/250
1 snodo 1/2"	920/25
1 quadro maschio 1/2" con spina scorrevole	920/42
1 cricchetto reversibile 1/2" \oplus	920/55
19 chiavi a bussola esagonali 1/2" \odot 10÷24 - 26 - 27 - 30 - 32 mm	920A
1 pinze regolabili cerniera chiusa 250 mm	1048
1 pinza autobloccante 240 mm	1052
1 pinze becchi dritti per anelli elastici, per fori \odot 180 mm	1032
1 pinze becchi piegati per anelli elastici, per fori \odot 170 mm	1034
1 pinze becchi dritti per anelli elastici, per alberi \bullet 175 mm	1036
1 pinze becchi piegati per anelli elastici, per alberi \bullet 175 mm	1038
1 flessometro 5 m	1692
1 miniseghetto	1725CR
1 oliatore in plastica 30 cc	1755
1 cutter con lama a settori	1771
5 lime a taglio mezzodolce 200 mm	1719BMA8/S5
5 chiavi combinate 22 - 24 - 27 - 30 - 32 mm	42
5 chiavi maschio con impugnatura per viti con impronta Torx® \odot T10-T15-T20-T25-T30	97TTX
13 chiavi a bussola esagonali 1/4" \odot 4-4,5-5-5,5-6-7-8-9-10-11-12-13-14mm	900
6 chiavi a bussola maschio esagonale 1/4" \odot 2,5-3-4-5-6-8 mm	900ME
1 prolunga - 1/4" 50 mm	900/20
1 prolunga - 1/4" 150 mm	900/21
1 snodo 1/4" 1/4 - 1/4	900/25
1 quadro con impugnatura 1/4"	900BG/30
1 quadro scorrevole 1/4"	900/42
1 cricchetto reversibile 1/4" \oplus	900/55
1 tronchesi a grande effetto taglienti diagonali ∇	1084BM
1 pinza universale \equiv	1150BM
1 pinza a becchi mezzotondi dritti \bullet	1166BM
2 scalpelli piatti nervati 100 - 200 mm	35
1 martello tipo tedesco 300 g	1370
1 mazzuola con battenti in materiale plastico \varnothing 35 mm	1390

9899C 1/4

Cassetta in plastica vuota per termoformati rigidi e morbidi da 1/4 di cassetto



Adatta per tutti i tipi di termoformati T e M da 1/4 di cassetto

098990606 480 g

€ 34,00 € 19,50

387x174x65 mm

M10

024500010

~~€ 366,00~~ € 213,00



22

42 6-7-8-9-10-11-12-13-14-15-16-17-18-19-20-21-22-24-27-30-32-36 mm

M30

024500030

~~€ 328,00~~ € 190,00



31

55 6x7-8x9-10x11-12x13-14x15-16x17-18x19-20x22
21x23-24x27-30x32 mm
90 6x7-8x9-10x11-12x13-14x15-16x17-18x19-20x22
21x23-24x27-30x32 mm
96BPC/SC9 1,5-2-2,5-3-4-5-6-8-10 mm

M60

024500060

~~€ 308,00~~ € 179,00



24

○ 96T 2-2,5-3-4-5-6-7-8-10 mm
○ 97BTX/SC8 T9-T10-T15-T20-T25-T27-T30-T40
○ 944BX 5-6-7-8-10-13 mm

M63

024500063

~~€ 279,00~~ € 162,00



8

○ 952 7-8-10-12-13-14-17-19 mm

M65

024500065

~~€ 422,00~~ € 245,00

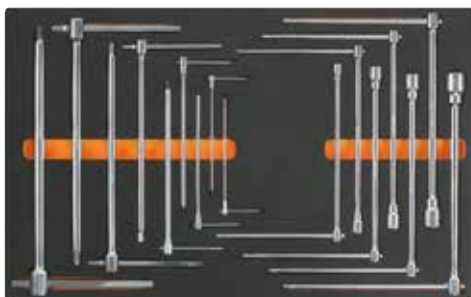

16

○ 950 8-10-12-13-14-17-19 mm
○ 951 2,5-3-4-5-6-8-10-12-14 mm

M100 12" 14"

024500100

~~€ 1.005,00~~ € 583,00



98

895/1 - 895/3 - 895/6
○ 900 4-4,5-5-5,5-6-7-8-9-10-11-12-13-14 mm
○ 900L 5-6-7-8-9-10-11-12-13 mm
○ 900ME 3-4-5-6-7 mm
● 900LP 0,8x4-1x5,5-1,2x6,5-1,2x8 mm
⊕ 900PH PH1-PH2-PH3-PH4
○ 900TX T10-T15-T20-T25-T27-T30-T40
900/20 50 mm - 900/20L 100 mm
900/21 150 mm
900/25 - 900BG/30 - 900/42
⊕ 900/55
○ 920A 8-10-11-12-13-14-15-16-17-18-19-20-21-22-23-24-26-27-28-30-32 mm
920/15 - 920/25
920AN/125 125 mm
920AN/250 250 mm
920/42
⊕ 920/55
⊕ 920FTX 10-12-14-16-18-20-22-24 mm
○ 920AL 10-12-13-14-15-16-17-18-19-21-22 mm

M121 ^{12"}

024500121

~~€ 992,00~~ € 577,00

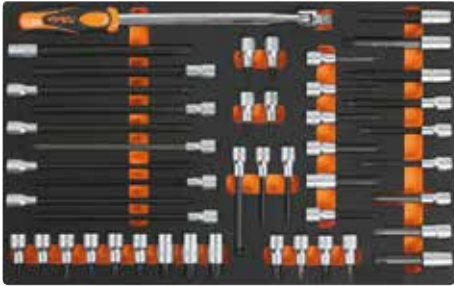

46

- 920BP 5L-6L-8L-10L-5XL-6XL-8XL mm
- 920TX T20-T25-T27-T30-T40-T45L-T50L-T55L-T60L-T70L
- 920XZN 4-5-6-6L-8-8L-10-10L-12-12L-14-14L-16-18 mm
- 920ES 7-9-10-11-12L-14L-16L-7XL-9XL-10XL-11XL-12XL-14XL-16XL mm
- 920/36A

M120 ^{12"}

024500120

~~€ 1.075,00~~ € 623,00



75

- 920A 10-11-12-13-14-15-16-17-18-19-20-21-22-24-26-27-30-32 mm
- 920AN/125 125 mm
- 920AN/250 250 mm
- 920/25 - 920/42
- 920AL 10-12-13-14-15-16-17-18-19-22-24-27-30-32 mm
- 920FTX 10-12-14-16-18-20-22-24 mm
- ⊕ 920/55
- 920PE 5-5L-6-6L-7-7L-8-8L-10-10L-12-12L-14-14L
- 920TX T20-T25-T27-T30-T40-T45-T50-T55-T60-T20L-T25L-T27L-T30L-T40L-T45L-T50L

M130

024500130

~~€ 342,00~~ € 199,00



13

- 1032 180 mm
- 1034 170 mm
- 1036 175 mm
- 1038 175 mm
- 1048 250 mm
- 1052 240 mm
- ⌘ 1082BM 160 mm
- 1098 220 mm
- 1112 250 mm
- 1128BM
- 1150BM 180 mm
- 1166BM 160 mm
- 1168BM 160 mm

M210

024500210

~~€ 167,50~~ € 97,50



25

- 1201 2,5x50-3x75-4x100-5,5x125-6,5x150-8x200 mm
- 1201N 4x30 mm
- ⊕ 1202 PH0x60-PH1x80-PH2x100-PH3x150 mm
- ⊕ 1202N PH1X30 mm
- 1207TX T6-T7-T8-T9-T10-T15-T20-T25-T27-T30-T40-T45
- 1253

M230

024500230

~~€ 322,00~~ € 187,00



25

- 30 Ø 2-3-4 mm
- 31 Ø 2-3-4-5-6-8 mm
- 32 Ø 4 mm
- 34 150 mm
- 35 200-250 mm
- 36 125 mm
- 1370 500 g
- 1390 Ø 35 mm
- 1692 3 m
- 1712
- 1719BMA/Q 200 mm
- ▲ 1719BMA/T 200 mm
- ▨ 1719BMA/P 200 mm
- ▶ 1719BMA/M 200 mm
- 1719BMA/R 200 mm
- 1737
- 1771 18 mm

M288

024500288

~~€ 497,00~~ € 114,00



9

- 1128BMX
- 1130BMX
- 1719BMA/Q 200 mm
- ▨ 1719BMA/P 200 mm
- ▶ 1719BMA/M 200 mm
- 1719BMA/R 200 mm
- 1726BM 400mm
- 1728BM (5)
- 1771BM 170 mm
- 1778V18 185 mm

T10 024240010
~~€ 222,50~~ **€ 129,00**



42 6-7-8-10-11-12-13-14
 16-17-18-19-21-22-24-27-30 mm

T15 024240015
~~€ 170,50~~ **€ 99,00**



42 6-7-8-9-10-11-12-13-14
 15-16-17-18-19-20-21 mm

T16 024240016
~~€ 121,00~~ **€ 70,00**



42 22-24-27-30-32

T31 024240031
~~€ 176,50~~ **€ 102,50**



31 Ø 2-3-4-5-6 mm
 32 Ø 4 mm
 55 6x7-8x9-10x11-12x13-14x15-16x17-18x19
 20x22-21x23-24x26-27x29-30x32 mm
 ○ 96N/SC9 1,5+10 mm

T40 024240040
~~€ 84,50~~ **€ 49,50**



90 6x7-8x9-10x11-12x13
 14x15-16x17-18x19 mm

T45 024240045
~~€ 251,00~~ **€ 146,00**



142 8-9-10-11-12-13-14
 15-16-17-18-19 mm

T46 024240046
~~€ 297,00~~ **€ 173,00**



142SN 8-9-10-11-12-13-14
 15-16-17-18-19 mm

T50 024240050
~~€ 141,00~~ **€ 81,50**



○ 96T 2-2,5-3-3,5-4-4,5-5-6-7-8-10 mm

T55 024240055
~~€ 79,00~~ **€ 46,00**



○ 97TTX T10-T15-T20 T25-
 T27-T30

T63 024240063
~~€ 271,00~~ **€ 157,00**



○ 952 7-8-10-12-13-14-17-19 mm

T83 024240083
~~€ 277,00~~ **€ 161,00**



12" ○ 920A 10-11-12
 13-14-15-16-17-18
 19-20-21-22-23-24
 26-27-30-32 mm
 920/21 125 mm
 920/22 255 mm
 920/25
 920/42 305 mm
 920/55 Ⓟ 275 mm

T85 024240085
~~€ 279,00~~ **€ 162,00**



- 861LP 0,5x3-0,6x4,5-0,8x5,5-1x5,5
 1,2x6,5-1,2x8-1,6x8 mm
- 861PE 2-2,5-3-4-5-6-8-10 mm
- ⊕ 861PH PH0- PH1 - PH2 - PH3
- ⊕ 861PZ PZ1 - PZ2 - PZ3
- 861TX T6-T7-T8-T9-T10-T15-T20-T25
 T27-T30-T40
- ⊕ 861RTX T9-T10-T15-T20-T25-T27-T30-T40
- ⊕ 861TRW 1-2-3-4-5-6 mm
- ⊕ 861TQS 0-1-2-3-4-5-6-8 mm
- ⊕ 861SP 4-6-8-10-12 mm
- 851SR 230 mm
- 900 4-4,5-5-5,5-6-7-8-9-10-11-12-13-14 mm
- 900/21 150 mm 900/25 41 mm
- 900BG/30 176 mm 900/42 115 mm
- Ⓟ 900/55 125 mm 194 1/4x5/16

T91 024240091
~~€ 184,50~~ **€ 107,50**



- 900 4-4,5-5-5,5-6
 7-8-9-10-11-12
 13-14 mm
- 900ME 2,5-3-4-5-6-8 mm
- 900/20 50 mm
- 900/21 150 mm
- 900/25
- 900BG/30 176 mm
- 900/42 115 mm
- Ⓟ 900/55 125 mm

T92 024240092
~~€ 221,50~~ **€ 129,00**



- 910A 6-7-8-9-10-11-12
 13-14-15-16-17-18
 19-20-21-22 mm
- 910/21 125 mm
- 910/22 250 mm
- 910/25
- 910/42 210 mm
- Ⓟ 910/55 200 mm

T103 024240103

~~€ 247,50~~ **€ 144,50**



- 900L 6-7-8-9-10-11-12 mm
- 920AL 13-14-16-17-18-19
21-22-24-27 mm

T131 024240131

~~€ 89,50~~ **€ 52,00**

- 1084BM 160 mm
- 1150BM 180 mm
- 1166BM 160 mm

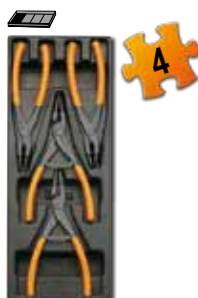
T145 024240145

~~€ 99,00~~ **€ 57,50**

- 1032 180 mm
- 1034 170 mm
- 1036 175 mm
- 1038 175 mm

T153 024240153

~~€ 61,50~~ **€ 35,50**

- 1048 250 mm
- 1052 240 mm

T199 024240199

~~€ 45,50~~ **€ 26,50**

- 1260 2,5x50 - 3x75
3,5x100 - 4x125 - 5,5x100
5,5x150-6,5x150 mm

T202 024240202

~~€ 42,50~~ **€ 24,50**

- ⊕ 1262 PH0x60 - PH0x100 - PH1x80
PH1x120 - PH2x100 - PH2x150 mm

T205 024240205

~~€ 61,50~~ **€ 36,00**

- 1267TX
T6-T7-T8-T9-T10-T15-T20

T210 024240210

~~€ 32,50~~ **€ 18,70**

- 1201 2,5x50-3x75-3,5x100-
4x125- 5,5x100-5,5x150 6,5x150mm

T212 024240212

~~€ 35,00~~ **€ 20,30**



- ⊕ 1202 PH0x60-PH1x80
PH1x120-PH2x100
PH2x150-PH3x150 mm

T215 024240215

~~€ 46,00~~ **€ 26,50**

- 1207TX
T6-T7-T8-T9-T10-T15-T20

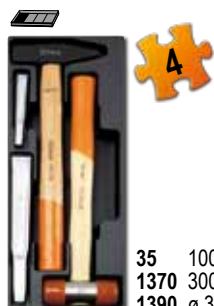
T234 024240234

~~€ 76,00~~ **€ 44,50**

- 35 100-200 mm
- 1370 300 g
- 1390 ø 35 mm

T236 024240236

~~€ 76,00~~ **€ 44,00**

- 1719BMA/Q 200 mm
- ▲ 1719BMA/T 200 mm
- 1719BMA/P 200 mm
- ▶ 1719BMA/M 200 mm
- 1719BMA/R 200 mm

T239 024240239

~~€ 101,50~~ **€ 59,00**

- 31BM Ø 2-3-4-5-6-8 mm
- 32 ø 4 mm

La Classica

Il processo produttivo della nostra classica chiave combinata è continuamente migliorato e aggiornato con le tecnologie più avanzate, per offrire sempre la miglior chiave possibile alle mani degli utilizzatori. I processi più complessi e critici, come stampaggio e brocciatura, sono automatizzati anche per migliorare la qualità dell'ambiente lavorativo



RAPIDITÀ

Angolo di 15° rispetto all'asse per ridurre l'angolo di ripresa

RESISTENZA

Grande resistenza: nel caso di uso improprio la chiave inizia a deformarsi, non si spezza in modo improvviso

OMOGENEITÀ

Lo stampaggio parte da un semilavorato a sezione tonda che garantisce alle fibre una distribuzione omogenea escludendo la formazioni di pericolose tensioni interne

ACCESSIBILITÀ

Spessori ridotti per migliorare l'accessibilità

PROTEZIONE

La nichel-cromatura garantisce nel tempo la protezione dagli agenti esterni e supera le impegnative prove di aderenza della norma ISO 2819

FORZA

Valori di coppia più che doppi rispetto ai requisiti della norma ISO 1711

OTTIMIZZAZIONE

La lunghezza della chiave, superiore alla maggior parte dei concorrenti, permette di ottenere coppie elevate con sforzo minore.

ERGONOMIA

L'occhio poligonale è inclinato di 15° per proteggere la mano. La forma è ottenuta da stampo, non piegata successivamente.

42/SP15

Serie di 15 chiavi combinate con supporto

☎ 6-7-8-9-10-11-12-13-14-15
16-17-19-22-24 mm



000420078 2,1 kg

~~€ 152,50~~ € 87,00

42/S17X

Serie di 17 chiavi combinate

☎ 6-7-8-10-11-12-13-14
15-16-17-19-21-22-24-27-30 mm



000420068 2,6 kg

~~€ 203,00~~ € 117,50

42/S26

Serie di 26 chiavi combinate

☎ 6-7-8-9-10-11-12-13-14
15-16-17-18-19-20-21
22-23-24-25-26-27-28
29-30-32 mm



000420070 5 kg

~~€ 370,00~~ € 213,00



42/SC9I

Serie di 9 chiavi combinate con supporto compatto

☎ 8-10-11-12-13-14-15-17-19 mm



000420087 900 g

~~€ 89,50~~ € 51,50

55/SP13

Serie di 13 chiavi a forchetta doppie con supporto

- 6x7-8x9-10x11-12x13
- 14x15-16x17-18x19
- 20x22-21x23-24x26
- 25x28-27x29-30x32 mm



000550186 3,5 kg

~~€ 143,50~~ € 83,00

142/SC9I

Serie di 9 chiavi combinate a cricchetto reversibile con supporto compatto

- 8-10-11-12-13-14-15-17-19 mm



001420087 1,2 kg

~~€ 178,00~~ € 102,00



142SN/SC9

Serie di 9 chiavi combinate a cricchetto snodate con supporto compatto

- 8-10-11-12-13-14-15-17-19 mm



001420259 1,3 kg

~~€ 213,00~~ € 122,50



90/S7

Serie di 7 chiavi poligonali doppie curve

- 6x7-8x9-10x11-12x13-14x15-16x17-18x19 mm



000900163 800 g

~~€ 75,00~~ € 43,50

192/S2

Serie di 2 chiavi poligonali a cricchetto reversibile

8 misure in 2 chiavi



001920070 500 g

~~€ 54,50~~ € 31,50

142C/A12

Serie di 12 chiavi combinate corte diritte a cricchetto in astuccio di tela

- 8-9-10-11-12-13-14-15-16-17-18-19 mm



001420175 1,3 kg

~~€ 185,00~~ € 106,00

111

Chiavi regolabili a rullino cromate con scala graduata

- Apertura della ganaschia mobile con rotazione destrorsa del rullino
- Scala millimetrata e in pollici

Doppia lettura mm-pollici



	L mm	A max.	g			
111/100	100	15 mm	60	001110010	€ 19,50	€ 11,30
111/150	150	24 mm	165	001110015	€ 20,50	€ 11,90
111/200	200	28 mm	325	001110020	€ 24,50	€ 14,20
111/250	250	34 mm	505	001110025	€ 30,50	€ 17,50
111/300	300	35 mm	790	001110030	€ 40,00	€ 23,00
111/450	450	54 mm	2043	001110045	€ 131,00	€ 76,00
111/600	600	62 mm	3300	001110060	€ 179,00	€ 104,00

944BX/D6

Serie di 6 chiavi a bussola esagonale profonda bimateriale tipo lungo

○ 5-6-7-8-10-13 mm

Betamax
MAXIMUM PERFORMANCE



009440056 1 kg

~~€ 100,50~~ € 58,50

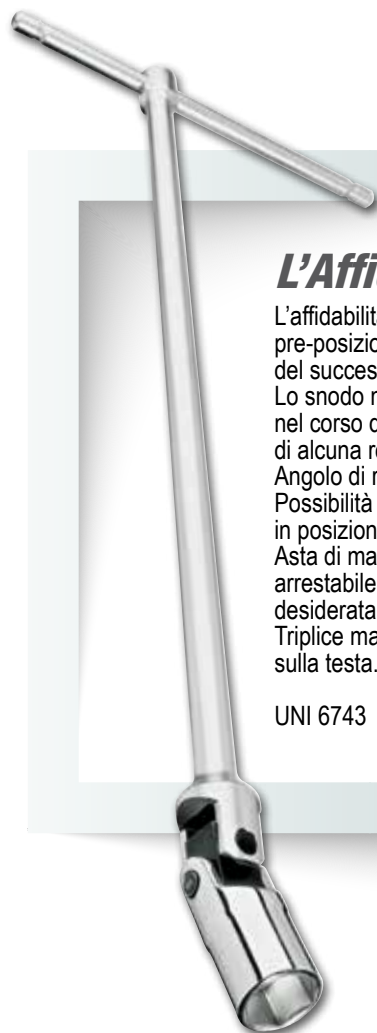

L'Affidabile

L'affidabilità e la precisione del pre-posizionamento sono le chiavi del successo di questa chiave. Lo snodo mantiene la propria funzione nel corso degli anni, senza bisogno di alcuna regolazione. Angolo di rotazione della bussola 50°. Possibilità di utilizzo a 90° in posizione fissa. Asta di manovra scorrevole, arrestabile nella posizione desiderata su tutta la lunghezza. Triplice marcatura della misura sulla testa.

UNI 6743

952/D7

Serie di 7 chiavi a T con bussola esagonagonale snodata

○ 7-8-10-12-13-14-17 mm

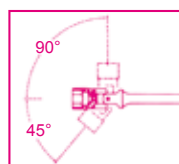

009520079 2,5 kg

~~€ 201,00~~ € 116,00

La Prima

L'impugnatura è di piccole dimensioni ed è perfettamente bilanciata per ruotare rapidamente nel palmo della mano. La forma ergonomica permette di utilizzarla anche per applicare coppie molto elevate. Le estremità esagonali sono calibrate per trasmettere la massima coppia possibile alla vite.



Lama passante all'interno dell'impugnatura



96T/S5P

Serie di 5 chiavi maschio esagonale piegate con impugnatura

Ø 2,5-3-4-5-6 mm



000960946 300 g

~~€ 52,00~~ € 29,50

97TTX/S6

Serie di 6 chiavi maschio piegate per viti con impronta Torx® con impugnatura

Ø T10-T15-T20-T25-T30-T40



000970791 400 g

~~€ 73,50~~ € 39,50

951/S6

Serie di 6 chiavi a T con tre estremità maschio esagonale

Ø 2,5-3-4-5-6-8 mm



009510687 600 g

~~€ 103,50~~ € 59,00



2÷6 mm



L'Originale

Quando nacque questa chiave, rappresentò una rivoluzione. Nata per lavorare su viti ad alta resistenza, offre rapidità di manovra, precisione dell'accoppiamento con la vite e flessibilità d'impiego.

L'astina scorrevole esagonale può essere regolata a piacimento.

Le estremità esagonali sono calibrate per trasmettere la massima coppia possibile alla vite.

La lunghezza dello stelo permette di applicare notevoli coppie alle viti senza eccessivo sforzo. I continui miglioramenti produttivi portano oggi ad avere finitura sabbata ed estremità esagonali a spigolo vivo, che permettono un accoppiamento migliore anche su viti rovinate. La marcatura eseguita a laser permette di aumentare la resistenza dello stelo.

Supporto con sistema di bloccaggio delle chiavi

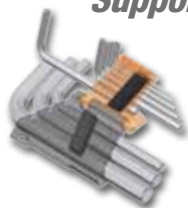

96BPA/SC9

Serie di 9 chiavi maschio esagonale piegate a 110° con un'estremità sferica, modello lato extra corto

LATO EXTRA CORTO



Ø mm	L mm
1,5	72
2	88
2,5	98
3	107
4	120
5	137
6	160
8	184
10	210

000961974 400 g

~~€ 40,00~~ € 21,00

97BTX/SC8

Serie di 8 chiavi maschio piegate con un'estremità sferica per viti con impronta Torx®



Ø mm	L mm
T9	65
T10	74
T15	84
T20	96
T25	98
T27	109
T30	123
T40	136

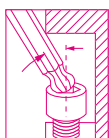

000970164 170 g

~~€ 64,00~~ € 34,50

96/SC9

Serie di 9 chiavi maschio esagonale piegate



Ø mm	L mm
1,5	42
2	48
2,5	59
3	62
4	70
5	81
6	92
8	102
10	116

000960374 300 g

~~€ 17,00~~ € 9,50

97BTXL/SC8

Serie di 8 chiavi maschio piegate con un'estremità sferica, modello lungo per viti con impronta Torx®



Modello extra lungo +25%

Ø mm	L mm
T9	83
T10	89
T15	103
T20	114
T25	130
T27	145
T30	166
T40	183



000970364 240 g

~~€ 73,50~~ € 39,50

96BPC/SC9

Serie di 9 chiavi maschio esagonale piegate con un'estremità sferica



Ø mm	L mm
1,5	79
2	85
2,5	89
3	100
4	110
5	129
6	152
8	173
10	194

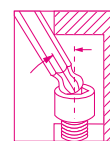

000960354 400 g

~~€ 36,00~~ € 17,90

96LBP/SC9

Serie di 9 chiavi maschio esagonale piegate con un'estremità sferica



Modello extra lungo +30%

Ø mm	L mm
1,5	91
2	100
2,5	113
3	130
4	142
5	163
6	185
8	205
10	231



000961354 500 g

~~€ 41,50~~ € 23,50



860MIX/A10 1/4

Serie di 10 inserti colorati con portainseri magnetico, in astuccio tascabile

- 860LP 0,5x3-1,0x5,5-1,2x6,5 mm
- + 860PH PH1-PH2 (x2)-PH3
- + 860PZ PZ1-PZ2-PZ3
- 882M1 \circ 1/4" - \bullet 1/4"

008600900 130 g

~~€ 29,50~~ € 17,20



860PHZ/A10 1/4

Serie di 10 inserti colorati con portainseri magnetico, in astuccio tascabile

- + 860PH PH1 - PH2 (x2) - PH3
- + 860PZ PZ1 - PZ2 (x3) - PZ3
- 882M1 \circ 1/4" - \bullet 1/4"

008600910 130 g

~~€ 29,50~~ € 17,20



860PE/A10 1/4

Serie di 10 inserti con portainseri magnetico in astuccio tascabile

- 860PE 2 - 2,5 mm
- 882M1 \circ 1/4 \bullet 1/4

008600920 130 g

~~€ 31,00~~ € 18,00



860TX/A10 1/4

Serie di 10 inserti con portainseri magnetico in astuccio tascabile

- ⊕ 860TX T7-T8-T9-T10-T15-T20-T25-T27-T30-T40
- 882M1 \circ 1/4 \bullet 1/4

008600970 130 g

~~€ 31,50~~ € 18,50



860/C27 1/4

Serie di 25 inserti colorati con raccordo e cricchetto reversibile in astuccio tascabile

- 860LP 0,5x3-1,0x5,5-1,2x6,5 mm
- 860PE 2-2,5-3-4-5-6-mm
- + 860PH PH1-PH2(x2)-PH3
- ⊕ 860TX T6-T8-T10-T15-T20-T25-T30-T40
- + 860PZ PZ1 - PZ2(2x) - PZ3
- 860/55 100 mm
- 892/0

- 860/55 100 mm
- 892/0



008600880 320 g

~~€ 71,00~~ € 41,00



860MIX/A31 1/4

Serie di 30 inserti colorati con portainseri magnetico in astuccio tascabile

- 860LP 0,5x3 - 0,6x4 - 0,8x5,5 - 1,0x5,5 - 1,2x6,5 mm
- 860PE 2-2,5-3-4-5-6-8-10 mm
- + 860PH PH0 - PH1 - PH2 - PH3 - PH4
- ⊕ 860RTX T9-T10-T15-T20-T25-T27-T30-T40
- + 860PZ PZ1 - PZ2 - PZ3 - PZ4
- 882MSR/50 \circ 1/4 \bullet 1/4

008600902 320 g

~~€ 70,00~~ € 40,80



862F/A7 1/4

Serie di 7 inserti a bussola esagonale magnetici, in astuccio tascabile

- 862F 5,5-6-7-8-10-12-13 mm

008620950 350 g

~~€ 41,00~~ € 23,60



1203/D8P  

Serie di 8 giravite

1201 ● 2,5x50-3x75-4x100-5,5x100-6,5x150 mm
1202 ⊕ PH0x60-PH1x80-PH2x100 mm 012030018 640 g~~€ 33,50~~ € 19,30**1203/D10N**  

Serie di 10 giravite

1201 ● 2,5x50-3x75-4x100-5,5x150-6,5x150 mm
1202 ⊕ PH0x60-PH1x80-PH2x100 mm
1201N ● 4x30 mm
1202N ⊕ PH1x30 mm 012030019 740 g~~€ 42,50~~ € 24,30**1207TX/D7** 

Serie di 7 giravite

1207TX ⊙ T6-T8-T10-T15
T20-T25-T30 012070207 560 g~~€ 43,50~~ € 25,20**1263/D8**  

Serie di 8 giravite

1260 ● 2,5x50-3x75-4x100-5,5x125-6,5x150 mm
1262 ⊕ PH0x60-PH1x80- PH2x100 mm 012630008 600 g~~€ 47,00~~ € 27,00**1263/D10**  

Serie di 10 giravite

1260 ● 3x75-3,5x100-4x125-5,5x150-6,5x150 mm
1262 ⊕ PH0x60- PH1x80-PH2x100 mm
1260N ● 4x30 mm
1262N ⊕ PH1x30 mm 012630010 690 g~~€ 60,00~~ € 34,30**1267TX/D7** 

Serie di 7 giravite

1267TX ⊙ T6-T8-T10-T15
T20-T25-T30 012670307 500 g~~€ 60,00~~ € 34,90**1293/D8**  

Serie di 8 giravite

1292 ● 2,5x50-3x75-4x100-5,5x125-6,5x150 mm
1292 ⊕ PH0x60-PH1x80- PH2x100 mm 012930403 730 g~~€ 65,50~~ € 37,80**1273MQ/D6**  

Serie di 6 giravite isolati

1274MQ ● 3x100-4x100-5,5x125 mm
1272MQ ⊕ PH0x60-PH1x80-PH2x100 mm 012730851 500 g~~€ 55,50~~ € 32,00**1273MQ/F-D6**  

Serie di 6 giravite slim isolati

1274MQ/F ● 0,5x3,5x100 - 0,8x4,5x100 -
1x5,5x125 - 1,2x6,5x150 mm
1272MQ/F ⊕ PH1x4,5x80- PH2x6x100 mm 012730406 500 g~~€ 64,50~~ € 37,50Disponibile
da Marzo

Novità

1000 V 1000 V 



Massima rapidità

Massima rapidità: solo 5° di ripresa.
Lunga durata: il dentello ha **17 denti** sempre in presa che garantiscono un'ottima distribuzione dello sforzo.
L'invertitore può essere regolato con una sola mano. La pressione della mano sulla testa del cricchetto non influisce sull'inversione.
Manutenzione e pulizia regolari, molto semplici da effettuare, ne prolungano la vita utile.

920/55L **12"**

Cricchetto estensibile reversibile con attacco quadro maschio 1/2" meccanismo a 72 denti

- Sistema di blocco dell'impugnatura

7 differenti lunghezze
Da 280 a 422 mm

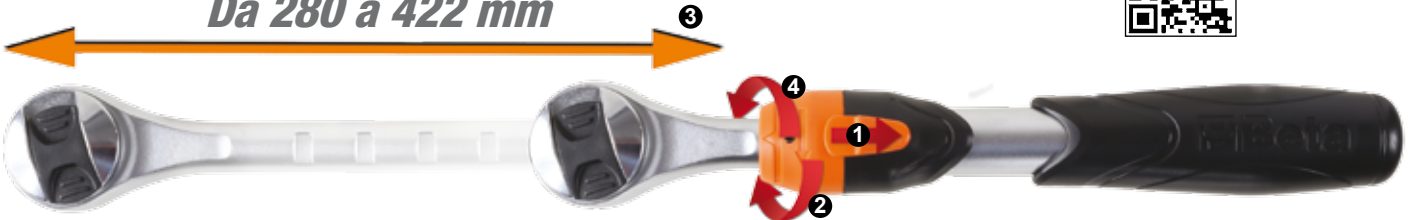

Estensibile fino al 70%
in più rispetto allo standard

009200927 1 kg

~~€ 88,00~~ € 50,50

12" **14"** **3/8"**

Cricchetto reversibile con impugnatura rotante

- Sistema di inversione a ghiera sulla testa del cricchetto
- Impugnatura bimatériale

Avvicinamento rapido del quadro con la sola rotazione dell'impugnatura



Pulsante di rilascio della bussola

A mm

Ø mm

	L mm	Ø mm	A mm	■	g		
900/58	126	28	28,5	1/4"	155	009000884	€ 58,50 € 33,50
910/58	222	37	38,5	3/8"	417	009100884	€ 64,00 € 37,00
920/58	281	42,5	45	1/2"	705	009200920	€ 75,50 € 43,00

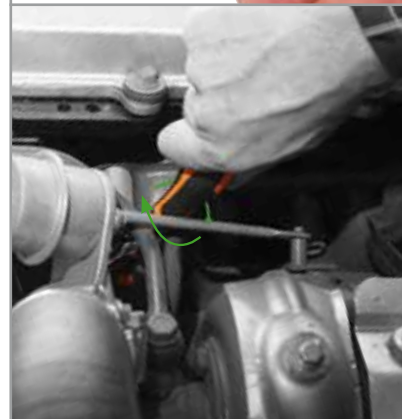



1/4" **1/4"**

Assortimento di 11 chiavi a bussola esagonali, 21 inserti e 7 accessori in cassetta di plastica

	861LP	●	0,6x4,5-1,2x6,5-1,2x8 mm
	861PE	○	2,5-3-4-5-6 mm
	861PH	⊕	PH1-PH2-PH3
	861PZ	⊕	PZ1-PZ2-PZ3
	861RTX	⊗	T10-T15-T20-T25-T27-T30-T40 mm
	892/0	●	1/4" - 1/4"
	895/1	○	1/4" - 1/4"
	900	○	5-5,5-6-7-8-9-10-11-12-13-14 mm
	900/20		50 mm
	900/20L		100 mm
	900/25		
	900BG/30C		

900/C39



con cricchetto reversibile (900/55)

009000937 785 g

€ 164,50 € 94,50



900/C39-R



con cricchetto reversibile manico rotante (900/58)

009000938 840 g

€ 188,50 € 107,50



1/4" **1/4"**

Assortimento di 12 chiavi a bussola esagonali, 20 inserti per avvitatori e 7 accessori in termoformato morbido, in cassetta di lamiera

	861LP	●	0,5x3-0,8x5,5-1x5,5-1,2x6,5 mm
	861PE	○	3-4-5-6-8 mm
	861PH	⊕	PH0-PH1-PH2-PH3
	861TX	⊗	T8-T10-T15-T20-T25-T30-T40
	895/1	○	1/4" - 1/4"
	900	○	4-5-5,5-6-7-8-9-10-11-12-13-14 mm
	900/20		50 mm
	900/21		150 mm
	900/25		
	900/42		
	900BG/30		



350x150x50 mm

900/C12M



con cricchetto reversibile (900/55)

009000963 1,2 kg

€ 184,50 € 107,00



900/C12MR



con cricchetto reversibile manico rotante (900/58)

009000962 1,3 kg

€ 204,50 € 118,00



902A/C22 **1/2"** **1/4"**

Assortimento di 22 chiavi a bussola esagonali, e 6 accessori, in cassetta di lamiera

1/4"		900	○	5-5,5-6-7-8-9-10-11-12-13 mm
		900/20		50 mm
		900/25		
1/2"		900/55	⊗	
		920A	○	10-13-14-15-17-18-19-22-24 27-30-32 mm
		920/21		125 mm
		920/25		
		920/55	⊗	



420x185x60 mm





009020807 3,5 kg

€ 302,00 € 174,00



3/8"

Assortimento di 16 chiavi a bussola esagonali e 5 accessori, in cassetta di lamiera

	910A	○	6-7-8-9-10-11-12-13-14 15-16-17-18-19-21-22 mm
	910/21		125 mm
	910/22		250 mm
	910/25		
	910/42		

≡ 335x145x60 mm



910A/C16

con cricchetto reversibile (910/55)

009100936 2,3 kg

€ 225,50 € 129,50



910A/C16HR

con cricchetto reversibile impugnatura rotante (910/58)





009100935 2,4 kg

€ 247,50 € 141,00



1/2"

Assortimento di 17 chiavi a bussola esagonali e 5 accessori in termoformato morbido, in cassetta di lamiera

	920A	○	10-11-12-13-14-15-16-17-18-19 20-21-22-24-27-30-32 mm
	920/21		125 mm
	920/22		255 mm
	920/25		
	920/42		

≡ 420x185x60 mm



920A/C17M

con cricchetto reversibile (920/55)

009200924 5 kg

€ 272,00 € 157,00



920A/C17MR

con cricchetto reversibile impugnatura rotante (920/58)







009200937 5,1 kg

€ 297,00 € 169,00



928A/C12 **3/4"**

Assortimento di 12 chiavi a bussola esagonali e 5 accessori, in cassetta di lamiera

	928A	○	22-24-27-30-32-34-36-38-41 46-50-55 mm
	928/21		200 mm
	928/22		380 mm
	928/25		
	928/42		
	928/55	⊗	

009280955 13,5 kg

€ 661,00 € 380,00





≡ 530x220x80 mm

920INOX/C16 **12"**

Assortimento 15 chiavi a bussola
e 1 cricchetto in acciaio inossidabile,
in cassetta di plastica

Novità

	920INOX-A	10-12-13-14-15-16-17-18-19 21-22-24-27-30-32mm
	920/55INOX	

009203916 3,1 kg

~~€ 957,00~~ **€ 555,00**

387x174x65 mm

1293INOX/D8

Serie di 8 giravite
in acciaio inossidabile



1290INOX 2,5x50-3x75-4x100
5,5x150-6,5x150 mm



1292INOX PH0x60-PH1x80-PH2x100 mm

012930408 550 g

~~€ 67,50~~ **€ 39,30****42INOX/SC9**

Serie di 9 chiavi combinate
in acciaio inossidabile
con supporto compatto

8-10-11-12-13-14-15-17-19 mm

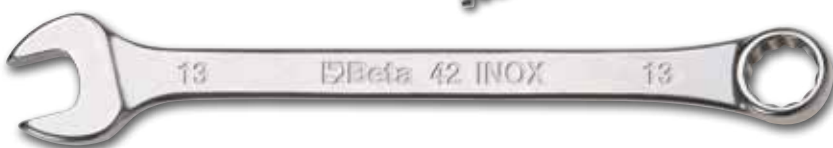

000420387 812 g

~~€ 151,00~~ **€ 87,00**

**GLI UTENSILI BETA INOX POSSONO ESSERE
STERILIZZATI IN AUTOCLAVE A 121 °C**

Gli utensili BETA INOX possono essere utilizzati
in ambienti critici, ovvero zone e aree in cui non è
ammesso il livello minimo di contaminazione.

Alcuni esempi sono:

- Produzione farmaceutica - classe C
- Applicazioni offshore
- Laboratori biotecnologici e biomedici
- Industria alimentare
- Applicazioni nucleari

Gli utensili Beta Inox evitano, inoltre, il fenomeno
della ruggine impropria. Quando si utilizzano utensili
non realizzati in acciaio inossidabile su viti, dadi o
superfici in acciaio inossidabile, dagli utensili si
possono staccare particelle che innescano processi
di corrosione, creando spesso problemi estetici, e,
alcune volte, problemi strutturali.

Esempi di applicazione sono:

- Cantieri navali, • Edilizia,
- Impianti solari, • Industria automobilistica.

CARATTERISTICHE

L'accurata scelta dei materiali¹ e la sapiente
ricerca dei migliori trattamenti termici conferiscono
agli utensili Beta Inox caratteristiche meccaniche
ampiamente superiori ai valori di norma e
comparabili a quelle dei normali utensili Beta.

L'ergonomia e il design dei prodotti sono gli stessi
degli utensili Beta, conosciuti e apprezzati dagli
utilizzatori professionali da più di 75 anni.

L'acciaio inossidabile è riciclabile al 100%.
Anche questa è una caratteristica importante.

¹ Beta Utensili utilizza acciaio AISI 420, magnetico.



ALTRI ARTICOLI INOX  **PAG. 7 e PAG. 14**

Chiavi dinamometriche a scatto con cricchetto reversibile per serraggi destrorsi

Precisione di serraggio $\pm 3\%$

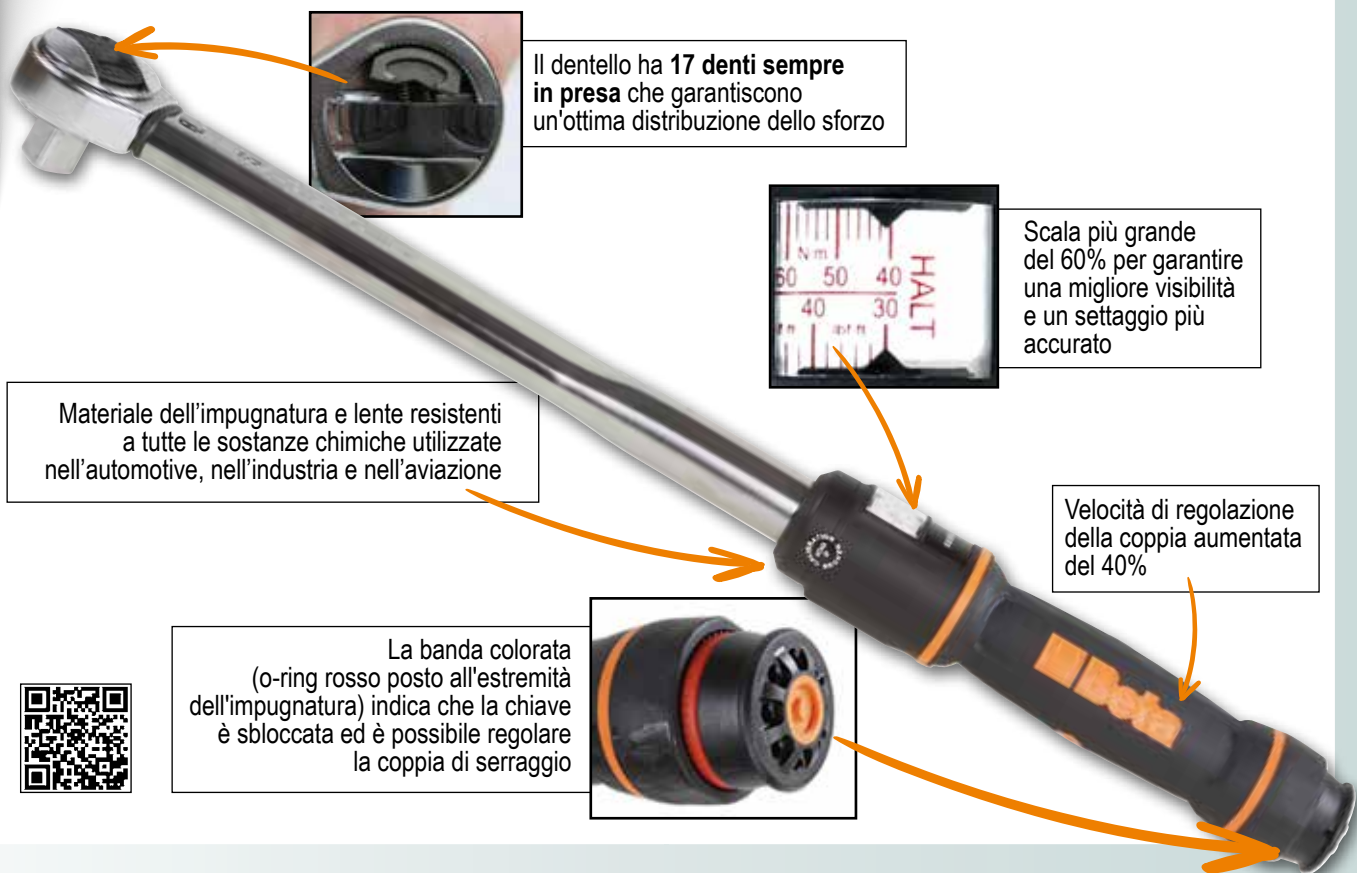

666N **14"** **3/8"** **12"**

Precisione di serraggio $\pm 3\%$
per serraggi destrorsi

	Nm	kgfm	lbf.ft	■	L (mm)	g		UNI EN 26789 ISO 6789	
666N/2	5÷25	0,5÷2,5	4÷18	1/4"	215	300	006660002	€ 262,00	€ 149,50
666N/2X	5÷25	0,5÷2,5	4÷18	3/8"	300	300	006660003	€ 268,00	€ 153,00
666N/5	10÷50	1÷5	7÷37	3/8"	312	660	006660005	€ 193,00	€ 108,00
666N/10X	20÷100	2÷10	15÷75	1/2"	387	800	006660011	€ 199,00	€ 111,00
666N/20	40÷200	4÷20	30÷150	1/2"	470	1010	006660020	€ 242,00	€ 118,50
666N/30	60÷300	6÷30	50÷220	1/2"	598	1380	006660030	€ 242,00	€ 135,00



605E **14"**

Precisione di serraggio $\pm 6\%$
per serraggi destrorsi e sinistrorsi

UNI EN 26789 ISO 6789



	Nm	kgfm	lbf.ft	■	L (mm)	g		UNI EN 26789 ISO 6789	
605E/5	1÷5	0,1÷0,5	10÷45	1/4"	190	180	006050105	€ 171,00	€ 99,00
605E/10	2÷10	0,2÷1,0	18÷90	1/4"	190	180	006050110	€ 180,00	€ 104,50

677/C 3/4"

Chiave dinamometrica a disinnesto in cassetta

Precisione di serraggio $\pm 4\%$ per serraggi destrorsi e sinistrorsi



677/C100

UNI EN 26789 ISO 6789

	Nm	kgfm	lbf.ft	■	L (mm)	kg			
677/C50	100÷500	10÷50	70÷350	3/4"	915	5,2	006770606	€ 761,00	€ 440,00
677/C70	150÷700	15÷70	100÷500	3/4"	1140	6,2	006770611	€ 791,00	€ 457,00
677/C100	300÷1000	30÷100	200÷750	3/4"	1470	7,5	006770615	€ 910,00	€ 525,00



599DGT-AN 1/2"

Chiave dinamometrica elettronica a lettura di coppia e angolo con cricchetto reversibile, per serraggi destrorsi (precisione $\pm 2\%$) e sinistrorsi (precisione $\pm 3\%$)

- Tipologie di serraggio: coppia, angolo, coppia + angolo
- Strategia di serraggio: coppia più angolo
- Doppia modalità di misura: picco e traccia
- Il raggiungimento della coppia o dell'angolo prefissati vengono segnalati da avvisatori luminosi e da un suono intermittente
- Memorizzazione dei dati di serraggio (fino a 250 valori)
- 9 valori di coppia/angolo preimpostabili
- Possibilità di impostare i limiti di tolleranza secondo le proprie esigenze; al loro superamento la chiave avvisa l'utente
- Blocco di sicurezza dei tasti
- Possibilità di associare la chiave a 16 utilizzatori tramite ID utente
- Tracciabilità dei dati di serraggio. Il software permette di memorizzare data e ora, numero di serie dell'utensile, valore di serraggio impostato, valore raggiunto, e di associarli all'ID utente
- Impugnatura bimatériau antiscivolo
- Inclusi: 2 batterie AA - 1,5V, cavo USB e software



Novità



Coppia + angolo

UNI EN 26789 ISO 6789

	Nm	kgfm	lbf.ft	■	L (mm)	kg			
599DGT-AN/10	20÷100	2÷10	15÷80	1/2	413	0,9	005990610	€ 595,00	€ 347,00
599DGT-AN/20	40÷200	4÷20	30÷150	1/2	520	1,3	005990620	€ 630,00	€ 368,00



561/1

Moltiplicatore di coppia rapporto 5:1 con due piedi di reazione

- Fornito con leva diritta e piede a 90°
- Ideale per l'utilizzo in spazi ristretti (\varnothing corpo 65 mm)
- Estremamente leggero (1,5 kg)
- Permette il serraggio destrorso e sinistrorso
- Precisione di serraggio: $\pm 4\%$
- Campo di applicazione 100-1000 Nm
- Quadro femmina 1/2"
- Uscita quadro maschio 3/4"

\varnothing 65 mm



005610010 2,7 kg

~~€ 1.010,00~~ € 582,00



1169/D4

Assortimento di 1 pinza universale,
1 pinza becchi mezzotondi lunghi,
1 tronchese e 1 pinza a cerniera chiusa

Novità



011690004 1,1 kg

~~€ 91,50~~ € 53,50



1048 250 mm



1082 160 mm



1150 180 mm



1166 160 mm

1169BM/D3

Assortimento di 1 pinza universale,
1 pinza becchi mezzotondi lunghi
e 1 tronchese



1082BM 160 mm

1150BM 180 mm

1166BM 160 mm

011690123 700 g

~~€ 78,00~~ € 45,00

1169MQ/D2

Assortimento di 1 pinza universale isolata
e 1 tronchese isolato



1150MQ 180 mm

1182MQ 160 mm

△ 1000 V

011690143 600 g

~~€ 80,00~~ € 46,50

1009L/DP-S2

Serie di 2 pinze a becchi mezzotondi
lunghissimi zigrinati
con doppio snodo



010090060 920 g

~~€ 60,00~~ € 34,50



1009L/DP

L 340 mm



1009L/D

1081

Tronchese a tagliente semiraso
manici ricoperti con 2 strati
di PVC antiscivolo
Per micromeccanica
ed elettronica gravosa



Novità

010810130 75 g

~~€ 23,00~~ € 13,40

1052

Pinze regolabili autobloccanti
ganasce concave



	L mm	Ø Max mm	g			
1052/140	140	22	175	010520014	€ 21,50	€ 12,30
1052/190	190	36	360	010520019	€ 24,30	€ 13,90
1052/240	240	42	590	010520024	€ 25,50	€ 14,80

1047/240

Pinza regolabile a pulsante

- Regolazione rapida e precisa mediante la pressione del pulsante
- Nessuno spostamento accidentale della regolazione
- Trattamento termico localizzato sulle ganasce



L 240 mm Ø Max 36 mm Max 32 mm

010470240 340 g

~~€ 38,00~~ € 22,00

1048

Pinze regolabili cerniera chiusa

- Manici ricoperti con 2 strati di PVC antiscivolo

9 posizioni



L 250 mm Ø Max 50 mm Max 48 mm

010480015 370 g

~~€ 29,00~~ € 16,80

1031/S4

Serie di 4 pinze per anelli
elastici di sicurezza

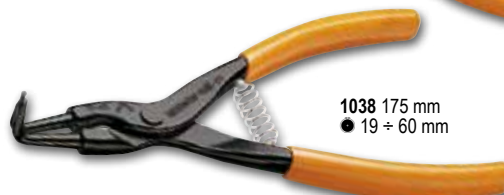
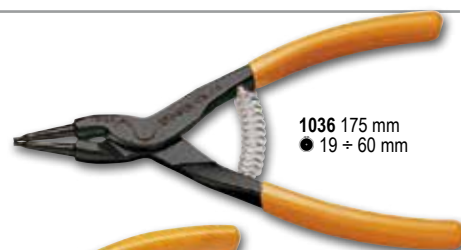

010310000 650 g

~~€ 89,00~~ € 51,00



31BM/D6

Serie di 6 cacciaspina con impugnatura

Ø 2-3-4-5-6-8 mm



000310420 805 g

~~€ 85,00~~ € 49,50

32AU

Bulino automatico con corpo brunito

- Forza d'urto regolabile fino a 50 Kg
- Utilizzabile con una sola mano



Ø 3 mm



L 150 mm

000320160 135 g

~~€ 45,00~~ € 26,50

1370T

Martelli tipo tedesco con manico in fibra di vetro



	g	g		€	€
1370T/200	200	328	013700620	€ 16,50	€ 9,90
1370T/300	300	452	013700630	€ 18,00	€ 10,60
1370T/500	500	663	013700650	€ 19,50	€ 11,40
1370T/800	800	1017	013700680	€ 21,00	€ 12,30
1370T/1000	1000	1279	013700700	€ 27,00	€ 15,80
1370T/1500	1500	1740	013700750	€ 31,50	€ 18,30

1390

Mazzuole con battenti intercambiabili in materiale plastico manico in legno



	Ø mm	g		€	€
1390/22	22	134	013900022	€ 15,00	€ 8,70
1390/28	28	230	013900028	€ 18,50	€ 10,80
1390/35	35	365	013900035	€ 25,00	€ 14,50
1390/45	45	698	013900045	€ 40,00	€ 23,30
1390/60	60	1462	013900060	€ 68,50	€ 40,00

1392

Mazzuole antirimbalo con battenti intercambiabili in materiale plastico manico in acciaio



	Ø mm	g		€	€
1392/30	30	575	013920030	€ 39,00	€ 23,00
1392/35	35	670	013920035	€ 42,00	€ 24,50
1392/40	40	796	013920040	€ 47,50	€ 28,00
1392/50	50	1206	013920050	€ 57,00	€ 33,50
1392/60	60	1505	013920060	€ 87,00	€ 51,00

412/SP19P

Serie di 19 punte elicoidali cilindriche, in acciaio HSS, rettificate lucide
 $\varnothing 1\div10 \times 0,5 \text{ mm}$

R ≤ 700 N/mm²
 HV ≈ 750÷820



004120429 590 g

~~€ 53,00~~ € 30,50

115x170x40 mm

415CO/SP19A

Serie di 19 punte elicoidali cilindriche, in acciaio HSS-CO 5%
 • Per forare acciaio INOX, acciai legati, ghisa, acciai dolci, leghe leggere
 $\varnothing 1\div10 \times 0,5 \text{ mm}$

R ≤ 1400 N/mm²
 HV ≈ 850÷920



004150440 590 g

~~€ 111,50~~ € 64,50

115x170x40 mm

420/A3



Novità

Serie di 3 frese diamantate

- A corona continua per il taglio a secco
- $\varnothing 6 - 8 - 10 \text{ mm}$

- *Gres porcellanato*
- *Piastrelle*



004200103 125 g

~~€ 199,00~~ € 115,00

Refrigerante vegetale che interviene durante il taglio

437U/09

Kit di ripristino delle filettature danneggiate

- M5X0,8
- M6X1,0
- M8X1,25
- M10X1,5
- M12X1,75



004370550 2 kg

~~€ 274,00~~ € 158,00

370x230x55 mm

446/C110

Assortimento di 105 maschi e filiere in acciaio al cromo, filettatura metrica in cassetta di legno



500x337x60 mm

435/0 444/1 436/1
 435/3 444/2



004460060 8 kg

~~€ 710,00~~ € 407,00

I III	433 M mm	440/440A M mm	441/441A M mm
2x0,4	6x0,75 - 7x0,75	2x0,4	6x0,75 - 7x0,75
3x0,5	8x0,75 - 8x1	3x0,5	8x0,75 - 8x1
4x0,7	9x0,75 - 9x1	4x0,7	9x0,75 - 9x1
5x0,8	10x0,75 - 10x1	5x0,8	10x0,75 - 10x1
6x1	10x1,25 - 11x0,75	6x1	10x1,25 - 11x0,75
7x1	11x1 - 11x1,25	7x1	11x1 - 11x1,25
8x1,25	12x0,75 - 12x1	8x1,25	12x0,75 - 12x1
9x1,25	12x1,25 - 12x1,5	9x1,25	12x1,25 - 12x1,5
10x1,5	14x1 - 14x1,25	10x1,5	14x1 - 14x1,25
11x1,5	14x1,5 - 16x1	11x1,5	14x1,5 - 16x1
12x1,75	16x1,5 - 18x1,5	12x1,75	16x1,5 - 18x1,5
14x2		14x2	
16x2		16x2	

426MD-3/A9

Novità

Serie di 9 mini frese rotative in metallo duro in cassetta di plastica

- Codolo da 3 mm
- Taglio incrociato tipo dolce con rompitruciolo
- Per lavori di precisione e finitura



004260349 100 g

~~€ 89,00~~ € 51,50

1128BAX BREVETTATA

Forbici per elettricisti a doppio effetto, con profili a fresa in acciaio inossidabile rivestito in DLC

Rivestimento DLC:

Il DLC (diamond-like carbon) è un rivestimento innovativo a base di carbonio: l'elevata durezza ed il basso coefficiente d'attrito nascono dalla simultanea presenza di carbonio depositato sulla superficie in forma di Grafite e Diamante.

- Alta durezza superficiale delle lame (resistenza all'abrasione e mantenimento dell'affilatura nel tempo)
- Basso coefficiente di attrito (scorrevolezza e potenza di taglio)
- Fornite con custodia plastica snodata

011280088 160 g

~~€ 26,00~~ € 15,00



**+durezza
-coefficiente
d'attrito**



**Taglio a doppio effetto:
-sforzo +potenza**



Profilo e fresa:
studiate per allargare fori su plastica da 13 a 25 mm.

1726

Seghetto con sistema di tensionamento della lama incorporato nell'impugnatura

017260001 600 g

~~€ 23,00~~ € 13,40



- archetto in acciaio verniciato
- impugnatura in lega di alluminio con sistema di tensionamento incorporato

1772M

Cutter a lama retrattile di sicurezza fornito con 4 lame

- Lama con rientro automatico a molla
- Corpo robusto in lega pressofusa
- Levapunti integrato nel manico



**Profondità di taglio
regolabile Ø÷25 mm**

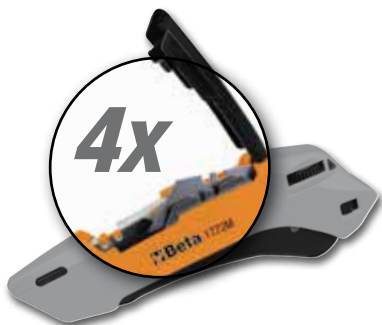

017720040 160 g

~~€ 15,00~~ € 8,70

Novità**1778U**

Coltello a serramanico lama in acciaio temprato in astuccio



017780070 176 g

~~€ 26,00~~ € 15,20

Novità

Calibro digitale a corsoio in acciaio inossidabile temprato in astuccio rigido di materiale plastico

- lettura centesimale
- bloccaggio a vite del corsoio
- conversione mm/pollici



DIN 862

UNI EN ISO 13385-1

1651DGT/150

A Max 150 mm L 225 mm

016510111 150 g

~~€ 105,00~~ € 61,00

1651DGT/200

A Max 200 mm L 285 mm

016510112 425 g

~~€ 122,00~~ € 70,00



Calibro a corsoio in acciaio inossidabile temprato

- Lettura ventesimale
- Bloccaggio a molla

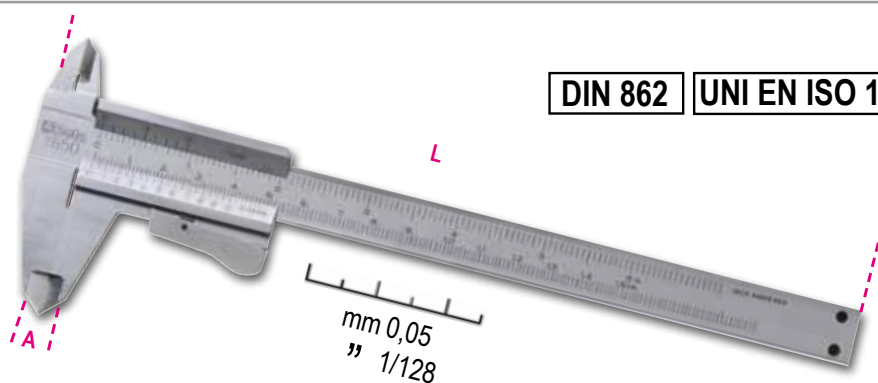

DIN 862

UNI EN ISO 13385-1

1650/150

A Max 150 mm L 235 mm

016500001 170 g

~~€ 50,50~~ € 29,50

1650/200

A Max 200 mm L 290 mm

016500002 230 g

~~€ 66,00~~ € 38,50

1691BM

Flessometri cassa bimateriale in ABS antiurto nastro in acciaio classe di precisione II



	L m	S mm	g			
1691BM/5	5	25	275	016910205	€ 12,90	€ 7,30
1691BM/8	8	32	490	016910208	€ 19,20	€ 10,80
1691BM/10	10	32	630	016910210	€ 23,20	€ 13,20

1433/C11

Serie di 11 estrattori a rulli per viti prigioniere con attacco quadro femmina 3/8" - 1/2" ed esagono di manovra in cassetta metallica con termoformato morbido

- Un sistema a rulli agisce con intensità progressiva sul prigioniero nel senso desiderato, destro o sinistro.

014330311 3 kg

~~€ 209,00~~ € 122,00

340x135x56 mm



1430/S8

Serie di 8 estrattori conici per viti e prigionieri danneggiati destrorsi in astuccio di plastica

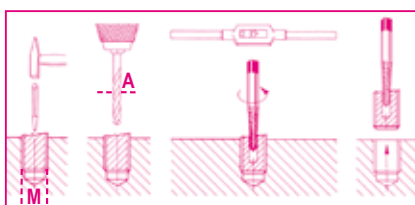

014300108 745 g

~~€ 66,00~~ € 38,70

	M	A mm
1430/1	3÷6	2,5
1430/2	6÷8	3,0
1430/3	8÷11	4,5
1430/4	11÷14	6,0
1430/5	14÷18	8,0
1430/6	18÷24	11,0
1430/7	24÷33	14,0
1430/8	33÷50	21,0



1500

Estrattori universali a 2 griffe

- impiego sia per esterni che per interni.
- griffe mobili lungo la traversa con dadi di bloccaggio.

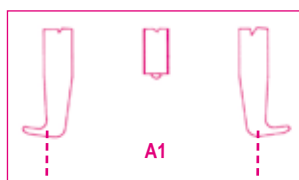

	A min÷Max	A1 min÷Max mm	L mm	L1 mm	● mm	Carico Max kg	kg			
1500/1	25÷80 mm	70÷130	100	135	17	4500	0,9	015000301	€ 68,00	€ 39,50
1500/2	25÷130 mm	80÷180	100	135	17	4500	1,1	015000302	€ 71,00	€ 41,50
1500/3	50÷160 mm	105÷220	150	210	22	6000	2,8	015000303	€ 117,00	€ 68,00
1500/4	60÷200 mm	120÷270	150	210	22	6000	3,1	015000304	€ 163,00	€ 95,00

1428/SB11 3/8" 1/2"

Serie di 11 estrattori a bussola per dadi danneggiati con supporto



014280111 822 g

~~€ 176,50~~ € 102,50

3/8" 8-10-11-12-13-14 mm 1/2" 15-16-17-18-19 mm

1547/C6

Estrattori per cuscinetti con false sfere

in cassetta di lamiera
 • utilizzabile solo dopo aver "sgabbiato" le sfere.

Cuscinetti:

1547/1

6011-6014, 6206-6211, 6303-6308, 6403-6405 1

1547/2

6004-6010, 6200-6205, 6300-6304



015470006 3 kg

~~€ 228,00~~ € 132,00

420x185x60 mm

1545/C5M

Estrattore 1542/1 con 5 Espansori 1544

● 24 mm

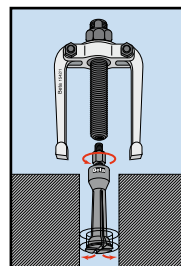

	A mm	C mm
1544/1	9÷12	0,80
1544/2	13÷17	1,15
1544/3	16÷21	1,70
1544/4	20÷25	1,65
1544/5	25÷30	2,00

015450011 2,4 kg

~~€ 437,00~~ € 253,00



265x180x45 mm

340

Cesoia tagliatubi per tubi multistrato

- Lama rivestita in PTFE
- 4 rulli di appoggio per facilitare la rotazione del tubo durante il taglio
- Corpo leggero in magnesio
- Ø max 26mm

Novità

Sistema per il taglio dei tubi corrugati integrato nel manico



003400001 280 g

€ 86,00 € 49,50

351C

Tagliatubi ed attrezzo bordatubi in cassetta di materiale plastico



354 Ø 3÷30 mm
1/8"÷1"1/8



225x150x45 mm



350 Ø 4÷14 mm



351P Ø 4-4,75-6-8-10-12-14 mm

- L'assortimento di sette puntali permette, di realizzare una bordatura doppia a 45°

003510010 1,6 kg

€ 119,00 € 69,00

334

Tagliatubi per rame Con lama svasatubi e leghe leggere

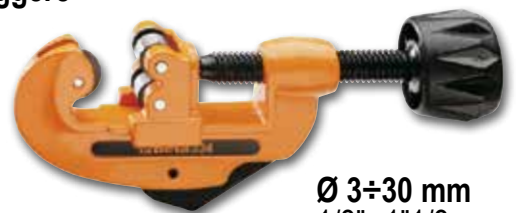

Ø 3÷30 mm
1/8"÷1"1/8

003340001 292 g

€ 24,50 € 14,20

342

Cesoia a cricchetto per tubi in materiale plastico



Ø 0÷42 mm
1"5/8

003420030 500 g

€ 41,50 € 24,30

388C/C8

Attrezzo curvatubi con 7 matrici in alluminio per rame ricotto e lega leggera in cassetta di plastica



400x330x110 mm



003880200 3,6 kg

€ 383,00 € 220,00



Ø 10,12,14,16,18,20,22 mm

186 8-32

Chiave autoserrante a ripresa automatica per esagoni da 8 a 32 mm

Ideale per viti con testa a profilo: esagonale, Spline®, quadrato, Torx®; anche rovinate.



L 260 mm

- SPLINE® 12 lati
- quadrato
- Torx®
- esagonale
- teste rovinate al 70%

001860008 560 g

€ 41,00 € 23,50

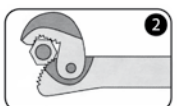
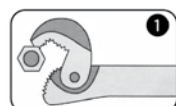

1606T

Pinza per capicorda a tubetto, crimpatura su 4 lati

Novità



016060005 450 g

€ 246,00 € 143,00

0,1÷10 mm²

1149F

Pinza spellafili frontale autoregolabile, con dispositivo di taglio

- Adattamento automatico ai diametri dei conduttori
- Lunghezza della spellatura regolabile
- Regolazione della pressione di taglio isolante
- Dispositivo di taglio integrato

0,2÷6 mm²



011490010 500 g

€ 14,00 € 8,10

1760/RMS

Multimetro digitale industriale con gomma esterna antiscivolo ed antiurto

- Ingressi protetti • Autoranging
- Ampio display di immediata lettura, retroilluminato blu
- Sonda temperatura tipo K (inclusa)
- Autospegnimento
- Base in gomma portaterminale per un maggiore comfort durante l'uso
- Terminali a doppio isolamento 1000V, lunghezza 1 m
- In custodia morbida
- CAT IV 600V/ CAT III 1000V
- Vero valore efficace TRUE RMS



	Campo di misura	
Tensione AC/DC	110mV - 600V ±0.8%	
Corrente AC/DC	110µA - 10A ±1.5%	
Resistenza	110Ω - 40MΩ ±1.2%	
Capacità	11nF - 40mF ±5%	
Frequenza	1100Hz - 110 MHz ±1.2%	
Temperatura	-32°C - +1000°C ±3%	
Test diodi	3V dc ±10% rdg	
Test continuità	<30 Ω	

Precisione base

- ±2% rdg
- ±2% rdg
- ±2.5% rdg
- ±10% rdg (fino a 11mF)
- ±1.5% rdg
- ±5% rdg



017600020 800 g

€ 239,00 € 139,50

1609B

Pinza crimpatrice meccanica

- Per capicorda in rame non isolati da 10 a 120 mm²
- Impugnatura in gomma antiscivolo
- Perno interno con sezione ad "H" per la massima scorrevolezza del punzone
- In acciaio brunito



10÷120 mm²

016090101 4,2 kg

€ 253,00 € 147,00

L 600 mm



1256/C36-2

Microgiravite bimatereale con 36 inserti intercambiabili da 4 mm e prolunga magnetica

per lavori di precisione



130x60x35 mm

	1256TX	⊗	T3-T4-T5-T6-T7-T8-T9-T10-T15
	1256RTX	⊗	T6-T7-T8-T9-T10
	1256LP	●	0,8-1,2-1,5-1,8-2-2,5-3-3,5-4 mm
	1256PE	○	0,7-0,9-1,3-1,5-2 mm
	1256PH	⊕	PH000-PH00-PH0-PH1
	1256PZ	⊕	PZ000-PZ00-PZ0-PZ1
	1256/20		
	1256/30		

012560100 200 g

€ 55,00 € 32,00

1740B 330

Rivettatrice di potenza compatta

Rapporto di leva ottimizzato per una maggiore compattezza e praticità d'uso
Testa regolabile per tirare il rivetto da 2 a 5 movimenti dei bracci

3,2÷6,4 mm acciaio



**3 griffe:
miglior presa
del rivetto**



*Serbatoio
portasteli*

017400330 1 kg

~~€ 69,00~~ € 40,00

1741B

Rivettatrice con 4 testine intercambiabili

- Struttura in lega leggera
- Con chiave di servizio



017410000 600 g

~~€ 31,50~~ € 18,20

1749AC

Pistola ad alta spinta per ancoranti chimici e cartucce standard



230 mm
STANDARD Ø 50 mm

017490005 1 kg

~~€ 31,00~~ € 18,20

1741U

Rivettatrice ultra compatta con regolazione dello sforzo fornita con 4 testine intercambiabili



L 200 mm



**3 griffe:
miglior presa
del rivetto**

017410450 450 g

~~€ 37,00~~ € 21,20

1750

Compressori a leva per grasso, 500 cc



550 Bar

017500500 1,2 kg

€ 34,00 € 19,70

1750TA

Testina per ingrassaggio a 6 spilli ad alta pressione

- Agevole disconnessione anche con testina in pressione
- Filetto M10x1: adatto a tutti i tipi di ingrassatore: elettrico, pneumatico, manuale, ecc.
- Nessuna deformazione fino a 550 bar



017500111 220 g

€ 36,00 € 20,70

Resiste fino a 550 bar



Autobloccante

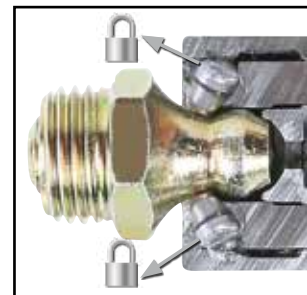

Una volta posizionata rimane in asse e collegata al nipplo.

Siringhe per olio in polipropilene

- Temperatura di funzionamento: +0 / +50°C
- Non adatta per carburanti e oli minerali
- Adatta anche al liquido impianto freni

1756C

017560502 250 g

€ 28,00 € 16,20

200 ml

Doppia guarnizione in EPDM

Ø 8 mm



1756D

017560515 690 g

€ 62,50 € 36,20

1500 ml

Doppia guarnizione in NBR





7042LCD

Maschera LCD ad oscuramento automatico, per saldatura ad elettrodo, MIG/MAG, TIG e plasma. Alimentazione a celle solari e batterie al litio per una durata eccezionale del filtro LCD

- Area di visuale 98x43 mm
- Tonalità di oscuramento DIN 9-13 con regolazione esterna
- Protezione UV/IR
- Tempo d'oscuramento 1/25000 s
- Tempo di rischiaramento 0.25-1s
- Sensibilità e ritardo dell'oscuramento regolabili
- Accensione e spegnimento automatici
- Funzione di smerigliatura
- Forma ottimizzata per agevolare la respirazione a schermo abbassato



070420001 900 g

~~€ 152,00~~ € 88,00

1860 160A

Saldatrice ad inverter con uscita corrente continua (DC) per saldature ad elettrodo MMA e TIG su acciaio. Compatte e facili da trasportare funzioni arc force, hotstart, anti-sticking, protezione termostatica

270 mm
370 mm
160 mm



Corrente di regolazione:	5+160A
Alimentazione:	1x230V
Fattore di utilizzo (40°C):	30% - 160 A 60% - 130 A 100% - 110 A
Fusibile ritardato:	25A
Protezione:	IP23S
Uso con generatori:	
Cavo:	25 mm ²
Elettrodi utilizzati:	Ø 1.5 - 4 mm rutilici, basici, inox, ghisa, ecc.

018600006 7,8 kg

~~€ 725,00~~ € 409,00

1860SQ

Squadra magnetica 45°/90°

- Ideale per bloccare particolari tubolari o piatti
- 40 kg di forza magnetica
- Non necessita batteria, effetto ON/OFF ottenuto con l'inclinazione dei magneti interni
- Pulizia da trucioli agevolata coi magneti in posizione OFF



40 kg



Novità



018600210 700 g

€ 67,00 € 39,00

1852R1750

Riscaldatore ad induzione portatile

- Riscalda e sblocca bulloni, dadi, mozzi e cuscinetti particolarmente bloccati senza l'utilizzo di fiamme
- Permette di scaldare qualsiasi tipo di metallo ferromagnetico

Massima sicurezza senza l'uso di fiamme

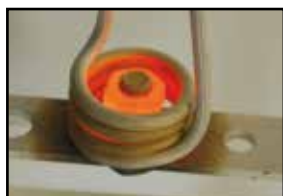

480x370x130 mm

Dati tecnici:

- Tensione di ingresso: 230V AC, 50/60 Hz
- Corrente di ingresso: max. 7,5A
- Potenza: max. 1.75 kW

VANTAGGI

- 1 Risparmio di tempo: riscaldamento veloce e con grande precisione
- 2 Sicurezza anti incendio: non genera fiamme, massima sicurezza per l'operatore
- 3 Praticità: utilizzabile con una sola mano e serpentine facilmente intercambiabili

CAMPI DI APPLICAZIONE

- Automotive
- Manutenzione industriale
- Industria aeronautica
- Industria navale
- Industria petrolchimica

Dotazione:

- Due serpentine frontali con diametro 19 e 26 mm per sblocco dadi ①
- Una serpentina piatta per scaldare le superfici ③
- Una serpentina flessibile lunga 800 mm ②
- Valigetta di plastica

018520175 4,5 kg

€ 1.195,00 € 690,00

1827F

Saldatore a gas butano ricaricabile

- Maxi serbatoio da 35g
- Tre ugelli intercambiabili da 550°C, 1000°C e 1300°C
- Fornito con cavalletto in valigetta rigida



Per deformare plastiche e sbloccare parti metalliche

018270200 1,5 kg

€ 120,00 € 70,00



Novità



1837N

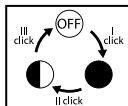

Lampada magnetica snodata con LED ad alta luminosità fino a 400 Lumen

- Batterie (non incluse) :
 - 1xAA (durata 25/69 h)
 - 2xAA (durata 33/96 h)
 - 3xAA (durata 43/124 h)
 • Lumen: 400>40>OFF
 • Indicatore di carica
 • Cono luminoso regolabile
 • IPX6

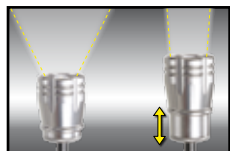

018370002 260 g

€ 67,00 € 39,00

1836A



Lampada da testa a LED, con doppia luminosità e sensore ON/OFF contactless

- 120/65 lumen
 • IP54
 • pile: 3xAAA incluse

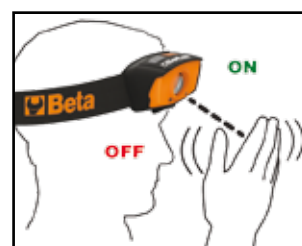

018360050 215 g

€ 42,00 € 24,50

Torcia LED ad alta luminosità in robusto alluminio anodizzato



1834P XL



018340330 300 g

€ 76,50 € 44,00



1834P L



018340325 270 g

€ 60,50 € 35,20



1834P M



018340320 120 g

€ 37,00 € 21,20



1834P S



018340310 56 g

€ 30,50 € 17,70



finitura opaca

1838COB



Lampada ricaricabile compatta con LED ad altissima luminosità.

- Batteria ai polimeri di litio
 • Corpo compatto in gomma antiscivolo
 • Gancio orientabile
 • Base magnetica orientabile a 180 gradi
 • Con caricatore 100-240Vac / 50-60Hz
 • 100 / 200 lumen - Spot 75 lumen
 • Autonomia: 6 h / 3 h
 • IP65

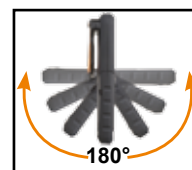

018380010 200 g

€ 73,50 € 42,50



120x59x25 mm



1838FLASH

Faretto ricaricabile ultracompatto, studiato per offrire la migliore soluzione possibile in ogni utilizzo

- LED ad altissima luminosità
- IP65
- Robusto ed affidabile
- Batteria ai polimeri di litio 7,4 V 4000 mAh

illuminazione abbondante e sempre pronta:

con una capacità illuminante massima di 720 Lumen e con la possibilità di lavorare a batteria o a cavo è sempre pronto all'uso

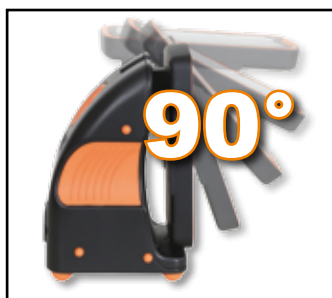

018380300 820 g

€ 265,00 € 153,00



85x100x155 mm

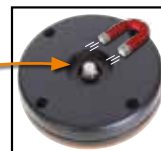

1838SLR

Lampada a LED snodata ricaricabile

- LED compatto frontale (200 lumen) e in testa per ispezioni (100 lumen)
- Corpo illuminante di soli 9 mm di spessore
- Autonomia di 5/2.5 ore (in base al livello di luce impostato)
- Con caricatore USB
- Con gancio metallico e magnete

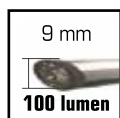

Compatta e versatile

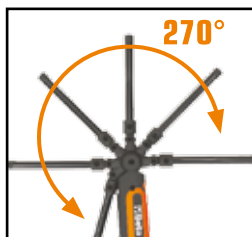

018380201 200 g

€ 84,50 € 50,00



242x41x30 mm



1838/11LED



Lampada ricaricabile con LED ad altissima luminosità batteria ai polimeri di litio

- Corpo compatto in gomma antiscivolo
- Con stazione di ricarica 110-230Vac/50-60Hz



Gancio orientabile



<20%



LED in testa per illuminazione multi direzionale



Vetrino frontale facilmente sostituibile

018380111 700 g

~~€ 130,00~~ € 75,00

1842LED/ABM



Lampada con LED ad altissima luminosità, 12-24 V; AC-DC

- Corpo compatto in gomma antiscivolo
- Vetrino frontale facilmente sostituibile
- Gancio orientabile
- Con LED in testa per illuminazione multidirezionale
- Cavo da 10 m



018420311 1,1 kg

~~€ 101,00~~ € 58,00

1846LED/BM



Avvolgitore automatico completo di lampada a LED, 100-240 Vac

- Con trasformatore di sicurezza 230/12V Max. 60 W
- Cavo da 15 m



018460301 5,8 kg

~~€ 325,00~~ € 186,50

1848



Avvolgitore automatico con presa Schuko

- Max 1600 W a cavo svolto
- Max 1200 W a cavo avvolto
- Cavo in gomma antischiacciamento H07 - 3x1.5 mm² - 15m
- Con protezione termica



15 m

018480015 5,2 kg

~~€ 293,00~~ € 166,50

Aspiratori

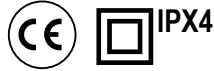

Caratteristiche tecniche:

1870 1871M

tensione:	230/240 V	230/240 V
frequenza:	50/60 Hz	50/60 Hz
potenza Max:	1200 W	1200 W
portata d'aria:	58 l/sec.	60 l/sec.
depressione Max:	190 mbar	220 mbar
capienza Max bidone:	20 l	35 l
emissioni acustiche:	<70 dB(A)	<68 dB(A)
lunghezza cavo:	5 m	7 m

Accessori in dotazione ø 36 mm:

1870 1871M

tubo corrugato:	✓	✓
tubi rigidi:	✓	✓
spazzola multiuso:	✓	✓
bocchetta a lancia:	✓	✓
raccordo di gomma Ø int.:	x	26 mm
SISTEMI FILTRANTI		
cartuccia filtro aria:	✓	✓
filtro anti-schiuma:	✓	✓
sacco in dotazione:	x	✓

1870

Aspiratore 20 litri per solidi e liquidi



Ruote antitraccia

018700020 6,9 kg

€ 180,00 € 104,00



1871M Classe certificata M

Aspiratore 35 litri per solidi e liquidi con prese di servizio corrente ed aria compressa



- pulizia automatica del filtro
- potenza Max presa di servizio 2000 W
- pressione Max attacco utensile pneumatico 15 bar



018710035 12 kg

€ 1.098,00 € 636,00



1972/12

Trapano avvitatore ultracompatto 12V

- Ultracompatto: 176 mm
- Ultraleggero: 1,1 kg
- Perfettamente bilanciato
- Doppia velocità con ingranaggi in acciaio e frizione a 18 posizioni
- Coppia fino a 34 Nm e 1500 giri/min (350 giri/min in 1° marcia),
- Impugnatura ergonomica antiscivolo
- LED frontale

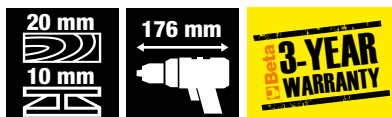

019720012 1,1 kg

€ 310,00 € 169,00

Ideale per lavorare in spazi ristretti



- Batterie da 2Ah con indicatore di carica sul corpo macchina
- Tripla autoprotezione della batteria (termica, sovraccarico e gestione dell'eventuale disparità di carica fra le celle)
- Forniti in valigetta rigida con 2 batterie agli ioni di litio da 2 Ah e caricatore rapido (45 min)

1982/12EF

Avvitatore reversibile ad impulsi 12V

- Coppia elevata: 115 Nm
- Elevata velocità: 0-2000 giri/min
- Attacco esagonale da 1/4" con ghiera di bloccaggio
- Ultracompatto: solo 163 mm di lunghezza
- Ultraleggero: solo 1,1 kg con batteria
- Triplo LED di illuminazione frontale
- IPM: 0÷3000



019820012 1,1 kg

€ 335,00 € 184,00



18V

1984/18QM

Avvitatore reversibile ad impulsi 18V Brushless

- Triplo LED di illuminazione frontale
- 4 modalità selezionabili:
 - 1: 270Nm; 1400 RPM
 - 2: 360Nm; 2000 RPM
 - 3: 450Nm; 2750 RPM
- A: Autostop- fino a che l'avvitatore rileva una rotazione libera applica il massimo della coppia/velocità (450Nm; 2750 RPM). Quando il bullone arriva a fine corsa e non ruota più, l'avvitatore continua ad applicare il massimo della coppia per 1 secondo poi si arresta
- IPM 0÷3500



12"



450 Nm

no polvere



270 Nm

360 Nm

450 Nm

Autostop

1/4"



12"



196 mm



019840018 2,3 kg

€ 890,00 € 489,00



BRUSHLESS

Motore digitale brushless senza spazzole: maggiore potenza, minori consumi di energia.

- Batterie da 5Ah con indicatore di carica
- Tripla autoprotezione della batteria (termica, sovraccarico e monitoraggio dell'eventuale disparità di carica fra le celle)
- Forniti in valigetta rigida con adattatore portainseri esagonale da 1/4" (1984/18MQ), 2 batterie agli ioni di litio da 5 Ah e caricatore rapido (80 min)



1972/18

Trapano avvitatore a percussione 18V Brushless

- Mandrino da 13 mm in acciaio
- Coppia fino a 75 Nm e 2100 giri/min (550 giri/min in 1° marcia)
- Doppia velocità con ingranaggi in acciaio e selettore per le funzioni di foratura, foratura con percussione e avvitamento con frizione a 20 posizioni
- LED di illuminazione frontale
- Impugnatura laterale in dotazione



2-13 mm



Scatola ingranaggi interamente metallica per migliorare robustezza e durata



192 mm



019720018 2,2 kg

€ 765,00 € 419,00



961D



Videoscopio digitale elettronico con sonda da 5,5 mm

Permette di visualizzare, fotografare e registrare singole immagini e filmati direttamente sullo strumento

Sonda Ø 5,5 mm con camera frontale e laterale con 4 led



Distanza ottimale di visualizzazione	2,5-30 cm
Alimentazione	3,7V - 4200 mAh
Autonomia stimata	2,5-4 ore
Risoluzione sensore	640x480 pixels (digitale) IP23S
Ampiezza di visualizzazione	60 gradi
Risoluzione di video e foto	640x480
Dimensioni	184x144x27 mm



009610500 520 g

€ 1.405,00 € 782,00

1760PA/AC-DC



Pinza amperometrica e multimetro digitale

PARAMETRI RILEVABILI
 Tensione DC: 0.1mV ÷ 600V
 Tensione AC: 0.1mV ÷ 600V
 Corrente DC: 0.01A ÷ 1000A
 Corrente AC: 0.01A ÷ 1000A
 Resistenza: 0.1Ω ÷ 40MΩ
 Capacità: 0.001nF ÷ 40 μF
 Frequenza: 0.001kHz ÷ 4kHz
 Temperatura: -40°C ÷ 1000 °C
 -40°F ÷ 1832°F



017600000 660 g

€ 264,00 € 152,00

1498/8A



IP65



Caricabatterie elettronico

- protezione di inversione di polarità, corto circuito
- display digitale retroilluminato
- gancio di fissaggio reclinabile
- funzione recupero batterie scariche
- funzione alimentatore 13,8V-5A

Tensione di alimentazione	220V-240V
Frequenza	50-60 Hz
Corrente nominale (Min-Max)	2-8 Amp
Tensione della batteria	12V
Capacità batteria	5Ah-160Ah
Grado di protezione	IP65
Tipo di batteria	Wet-Gel-Dry-AGM

014980108 1,2 kg

€ 178,50 € 102,50



1498/30A



Caricabatterie elettronico 6-12-24 Volt multifunzione

Permette la carica delle batterie e alimenta i veicoli durante le operazioni di diagnosi

- corrente massima di carica 30A continui
- carica e mantenimento
- funzione recupero batterie
- alimentazione ECU
- protezione contro inversione polarità, corto circuito, voltaggio errato e sovraccarico

Alimentazione	220-240V
Potenza	1500 Watt
Corrente di carica	5-30A
Tipo batterie	Agm-Wet-Lithium (LiFePo4)
Capacità di carica	5-300Ah
Capacità di mantenimento	5-900Ah
Tensione in uscita	6-12-24 Volt
Dimensioni	330x270x130 mm

014980130 4,2 kg

€ 845,00 € 469,00



Novità

1498/120A**Novità**

Caricabatterie elettronico 12 Volt multifunzione

Permette la carica delle batterie e l'alimentazione dei veicoli durante tutte le fasi di riprogrammazione e autodiagnosi

- corrente massima di carica 120A continui
- carica e mantenimento con microprocessore CPU
- funzione recupero batterie
- alimentazione ECU
- protezione contro inversione polarità, corto circuito, voltaggio errato e sovraccarico



014980142 8,5 kg

€ 2.350,00 € 1.350,00



Alimentazione	90-260V
Potenza	1500 Watt
Corrente di carica	10-120A
Tipo batterie	Agm-Wet-Lithium (LiFePo4)
Capacità di carica	10-1200Ah
Capacità di mantenimento	5-3600Ah
Tensione in uscita	12 Volt
Lunghezza cavi con pinze	2700 mm
Dimensioni	310x150x350 mm

*Ideale per i protocolli
diagnosi e la
riprogrammazione
centrale*

1498TB/12-24 

Tester digitale per batteria 12V e analizzatore sistema di avviamento e ricarica 12-24V

Permette di effettuare i seguenti test: batteria, alternatore (intelligente e normale), avviamento, ripple di diodo e prova di messa a terra

- dotato di software per stampare il test eseguito da PC
- display retroilluminato
- struttura compatta e antiurto
- dotato di un apposito ingresso per il collegamento di una mini stampante estraibile (accessorio opzionale Beta 1498ST/TB)



*Display
retroilluminato*

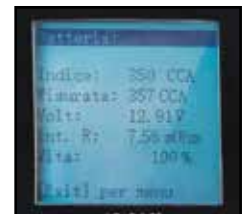

*Software
in 10 lingue*

Applicazioni	- Test batterie 12V - Test alternatore 12-24V - Test sistemi avviamento
Intervallo di funzionamento	100-2000 CCA
Normative di riferimento	CCA, SAE, DIN, EN, IEC, JIS
Batterie supportate	PB, WET, GEL, AGM, AGM FLAT, EFB
Voltmetro	9V-36V
Lunghezza cavi	1600 mm
Lingue	Italiano, Inglese, Francese, Tedesco, Spagnolo, Polacco, Rumeno, Olandese, Svedese e Finlandese
Accessori inclusi	Cavo USB e Software

014980401 1,5 kg

€ 545,00 € 313,00



435x320x100 mm

1498LT/12

Avviatore portatile ultraleggero ad alte prestazioni

Include funzione salva memorie



4000A

Solo 2,5 kg!

Tensione di utilizzo	12V
Amperaggio continuo	800A
Amperaggio massimo di avviamento	2000A
Amperaggio di picco	4000A
Lunghezza cavi	500 mm
Tipo batteria	4 celle LifePo4
Funzione Salva memoria	Si
Dimensioni	260x135x72 mm

Dotato di alimentatore di ricarica 12 V 1,3A

 014980012 3,4 kg

~~€ 688,00~~ **€ 395,00**



1498/24

Avviatore portatile per auto e veicoli commerciali 12-24 V

- corrente di spunto 4200 A (12 V), 2100 A (24 V)
- batteria ermetica al piombo electrolyte solido (AGM)

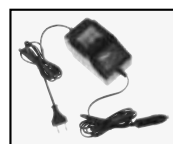

 014980490 17 kg

~~€ 1.135,00~~ **€ 649,00**



1498MN/12

Avviatore d'emergenza portatile multifunzione per auto e motocicli

Dotazione:

- cavo di avviamento con pinze isolate e diodo di protezione
- caricabatteria da rete
- caricabatteria da auto
- cavo USB con adattatori di carica



corrente di picco	600A
uscita USB	5V 1A-2A
dimensioni	190x85x35 mm
uscita per avviamento	12 Volt

 014980000 542 g

~~€ 295,00~~ **€ 170,00**



 240x185x60 mm

1498/40A

Caricabatterie avviatore multifunzione 12-24V carrellato

- processi specifici di carica WET-SPIRAL/GEL-AGM
- sistema di controllo e protezione elettronico
- funzione desolfatazione e recupero batteria
- funzione supply
- idoneo anche per batterie Start&Stop

2 in 1
caricabatterie
+ avviatore

800 mm
280 mm
300 mm

Alimentazione	230V
Tensione in uscita	12-24V
Corrente di carica	1-40A
Corrente di avviamento	350A max cc
Capacità di ricarica	4-450Ah
Dimensioni	300x800x280 mm

 014980140 8,5 kg

~~€ 963,00~~ **€ 558,00**





Carrello multifunzione

Utilizzabile come postazione mobile per strumenti di diagnosi, laptop, tester e caricabatterie.

- Struttura in lamiera verniciata: massima stabilità e solidità
- Maniglia ergonomica
- 2 ruote posteriori fisse Ø 160 mm
- 2 ruote anteriori girevoli Ø 125 mm (una con freno)



Novità

CA49-G

Carrello multifunzione con antenna, vuoto



CX49-G

Carrello multifunzione, vuoto



1099 mm
460 mm
435 mm

Piano di appoggio superiore su 2 livelli



Cassetto estraibile per mini tastiera

Ripiani centrali con posizione regolabile e ripiano basso fisso



1 portacarta



4 utili avvolgicavo laterali in plastica



2 pratici contenitori laterali



1099 mm
460 mm
435 mm



049000112 36,5 kg

€ 625,00 € 365,00



049000102 36 kg

€ 555,00 € 319,00

1464T

Tester digitale per la misurazione di pressione e compressione

014640050 1,1 kg

~~€ 710,00~~ € 408,00



CARATTERISTICHE

- display touch screen da 5"
- batteria ai polimeri di lito ricaricabile
- completo di sensore da 80 bar (basse pressioni) e cavo USB

Set per tester multifunzione

1464PB

Set di 9 connessioni per la verifica della bassa pressione carburante (da utilizzare con 1464T)

Attraverso le connessioni rapide collegate al tester 1464T si effettua rapidamente la verifica della bassa pressione carburante nei motori diesel e benzina



014640700 3,8 kg

~~€ 432,00~~ € 250,00

530x440x120 mm

Novità

1464FG

Set di falsi regolatori per la verifica del sistema diesel Common rail (da utilizzare con Beta 1464T-1464AP)

Utilizzato con il tester e gli adattatori idonei, permette di stabilire se il problema risiede nella pompa alta pressione o nel regolatore in caso di assenza di pressione nel circuito di alta pressione nei motori diesel common rail.

BOSCH

DELPHI

DENSO

SIEMENS

Indicato per regolatori di pressione Bosch, Delphi, Denso e Siemens



014640470 1,8 kg

~~€ 246,00~~ € 142,00

350x250x80 mm

960AD/TP2

Set di adattatori per 1464T

- finti iniettori
- finte candele
- adattatori candela
- adattatori tappi olio
- raccordi iniezione benzina
- set guarnizioni di ricambio



009600510 3,7 kg

~~€ 421,00~~ € 242,00

430x310x50 mm

1464AP

Set per la verifica dell'impianto alta pressione dei motori diesel Common rail, con 1464T

- set tubi alta pressione
- raccordi di collegamento
- sensore da 2.000 bar



014640450 1,8 kg

~~€ 639,00~~ € 370,00

430x310x50 mm

1464APB 

Set per la verifica dell'impianto
alta pressione benzina dei motori FSI,
da utilizzare con 1464T

Include sensore da 200 bar
e raccordi di collegamento



014640500 600 g

~~€ 315,00~~ € 182,50

240x210x50 mm

1464TDI 

Set per la verifica della pressione
della pompa nei motori TDI
da utilizzare con 1464T

Include raccordo
di collegamento



014640600 400 g

~~€ 97,50~~ € 57,50

240x210x50 mm

1464IC 

Set di finti iniettori e finte
candelette per 1464T

Permette di collegarsi al motore
per la verifica della compressione
nei motori diesel con tester digitale 1464T



014640350 4,5 kg

~~€ 470,00~~ € 273,00

- n° 22 false candele
- n° 5 falsi iniettori
- n° 1 kit falso iniettore universale
per truck, motori marini
e macchine agricole

559x312x50 mm

1464PF 

Set per la verifica della pressione
nell'impianto frenante da utilizzare con 1464T

Include adattatori, sensori e raccordi



014640650 3 kg

~~€ 568,00~~ € 329,00

600x280x60 mm

1464PT 

Set per la verifica
della pressione del turbo,
da utilizzare con 1464T

Include sensore e cavo di collegamento



014640550 380 g

~~€ 137,00~~ € 81,00

240x210x50 mm

960KPC 1/4"

Estrattore reversibile ad impulsi con coppia regolabile per candele di preriscaldamento

- l'estrattore pneumatico a coppia regolabile e le bussole speciali consentono di svitare le candele bloccate riducendo al minimo il rischio di danneggiamento
- 5 bussole da 1/4" macchina lunghe, speciali per candele: 8-9-10-11-12 mm, 2 prolunghe e 1 snodo
- 4 coppie di serraggio regolabili: 10-20-30-40 Nm
- regolazione destrorsa e sinistrorsa



≡ 420x185x60 mm

009600780 2,9 kg

~~€ 263,00~~ € 153,00

Evita la rottura delle candele durante lo smontaggio

960KC-M8/M9/M10

Assortimento di utensili per la rimozione delle candele di preriscaldamento spezzate o danneggiate

Per candele con filetto M8-M9-M10



≡ 380x290x50 mm

009600801 2,5 kg

~~€ 347,00~~ € 200,00



960EPC

Set di utensili per l'estrazione dell'elettrodo delle candele di preriscaldamento

- permette una corretta e rapida estrazione della parte terminale dell'elettrodo in caso di rottura o grippaggio all'interno della sede della candela.
- adatto per candele con filettatura: M8x1 - M9x1 - M10x1 - M10x1,25



ZONA DI ROTTURA

009600790 960 g

~~€ 509,00~~ € 296,00

≡ 270x230x80 mm



960PI/C19**Novità****Assortimento di 19 utensili per la pulizia sedi iniettori**

Inclusi nel kit:

- 11 alesatori piatti Ø: 14/14 mm - 15,5/15,5 mm - 15/19 mm - 17/19 mm - 17/17,5 mm - 17/19 mm - 17/19,5 mm - 17/20 mm - 18/21 mm - 19 mm - 20/21 mm
- 4 alesatori ad angolo Ø: 15,5/15,5 mm - 17/17 mm - 17,5/20,5 mm - 17/21 mm
- Impugnatura ed accessori per utilizzo frese

15 frese

009600217 2,5 kg

~~€ 240,00~~ € 139,00

360x230x60 mm

1759HD/3**Strumenti per controllo tenuta impianto di raffreddamento e riempimento circuito**

Permette di verificare sotto pressione le perdite del circuito (tubi, giunti, pompe, radiatori) e riempire velocemente il circuito evitando la formazione di bolle d'aria.



017590063 6,8 kg

~~€ 465,00~~ € 270,00

600x500x140 mm

1472FC/GE**Novità****Pinza a grande effetto, per fascette Clic®**

Particolarmente indicata per fascette di grandi dimensioni

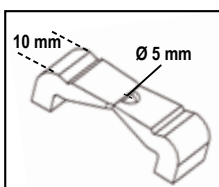

014720093 200 g

~~€ 58,00~~ € 33,50L mm
230**1758****Novità****Imbuto autoadattante**

Particolarmente utile per auto prive di profondità all'interno del tappo di carico



017580020 400 g

~~€ 43,50~~ € 25,00

1485BPM

Attrezzo a mezzaluna con ganasce in alluminio per bloccare pulegge multigola

Regolabile tramite manico girevole, stringe e blocca la puleggia dall'esterno, evitando danni ai sensori circostanti



Manico girevole

014850002 1,6 kg

€ 154,00 € 89,50



Novità

1485MTJ/1.3

FCA
FIAT CHRYSLER AUTOMOBILES

Attrezzo blocca puleggia catena distribuzione motori 1.3 Multijet

Grazie ai 5 precisi perni di bloccaggio, permette di operare sulla catena in totale sicurezza



014850160 750 g

€ 71,50 € 41,00



Novità

1529/C7

Estrattore per pulegge

Incluse nel kit:

- 2 griffe con doppio piede spesso 4,7 mm
- 2 griffe a singolo piede spesso 4,3 mm
- 1 griffa con doppio piede spesso 2,3 mm
- 1 griffa a singolo piede spesso 2,3 mm

La coppia di griffe è componibile in base all'esigenza operativa



285x155x50 mm



015290100 2 kg

€ 121,00 € 69,50

1485PMTJ

FCA
FIAT CHRYSLER AUTOMOBILES

Leva sbloccaggio pulegge albero motore Multijet

Geometria appositamente studiata per bloccare l'albero motore durante le operazioni di rimozione della puleggia



014850190 1,3 kg

€ 103,00 € 59,50



L mm
450

Novità

1485FRD/T

Ford

Leva per il tensionamento delle cinghie dei servizi, montate su motori Ford

Utilizzabile per la rimozione delle pulegge degli alternatori



014850310 700 g

€ 64,00 € 37,00

L mm Q mm
450 12,80

Novità

1485FCA/K2
Coppia di attrezzi per precaricare i cuscinetti della cinghia di distribuzione del gruppo FCA

Indicati per motori 1.2, 1.4 8/16 V e 1.4 Multiair

- 1 attrezzo lungo 175 mm con puntali da 13,5 mm
- 1 attrezzo lungo 305 mm snodato con puntali da 13,5 mm

Novità

014850220 300 g

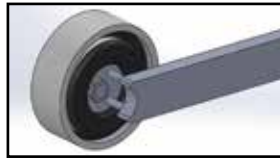
~~€ 82,50~~ € 47,50

Vasca di lavaggio ad ultrasuoni con funzione speciale di degassificazione

- Attraverso il riscaldamento del liquido e con l'azione degli ultrasuoni permette di pulire efficacemente parti di ricambio e pezzi metallici in genere (iniettori, carburatori, valvole, ecc...)
- Display digitale con regolazione della temperatura e del tempo di lavaggio
- Doppia funzione lavaggio: "soft" e "normal"
- Per una pulizia generale è sufficiente usare acqua ad una temperatura di 50/60°C
- Per una pulizia più accurata aggiungere soluzioni detergenti non schiumogene (tipo Arexons Fulcron Extra) specifiche per vasche ad ultrasuoni
- La funzione degassificazione accelera la liberazione d'aria in tutto il volume della vasca aumentando l'efficacia degli ultrasuoni

1895 6 1895 13 1895 27

Capacità vasca	6 litri	13 litri	27 litri
Rubinetto di scarico	✓	✓	✓
Potenza	150 Watt	300 Watt	500 Watt
Potenza di riscaldamento	300 Watt	400 Watt	500 Watt
Regolazione temperatura	0÷80°C	0÷80°C	0÷80°C
Regolazione tempo di lavaggio	0-99 minuti	0-99 minuti	0-99 minuti
Frequenza	40 kHz	40 kHz	40 kHz
Alimentazione	220/230V	220/230V	220/230V
Dimensioni	330x180x310 mm	350x325x320 mm	530x330x380 mm
Dimensioni serbatoio	300x155x150 mm	325x235x145 mm	500x300x200 mm

Flacone incluso

Ideale per iniettori e valvole EGR
6 litri
1895 6

018950060 8,1 kg

~~€ 578,00~~ € 336,00

13 litri
1895 13

018950130 12,5 kg

~~€ 890,00~~ € 515,00

Novità
27 litri
1895 27

018950270 13,5 kg

~~€ 1.235,00~~ € 710,00

Novità

1438K/DSG

Novità

Set di 13 attrezzi per lo smontaggio, montaggio e registrazione delle frizioni VW DSG a 6 e 7 rapporti

Permette di intervenire sulle trasmissioni a cambio automatico ed elettronico doppia frizione. Include una pinza per la rimozione/installazione dell'anello di sicurezza dell'albero primario e il calibro di registrazione per il sistema di innesto delle frizioni



014380250 5,2 kg

~~€ 736,00~~ € 423,00

500x390x135 mm

1884

Attrezzo per l'inserimento di olio nei cambi manuali, automatici e nei differenziali

Completo di 12 adattatori per la connessione diretta

- dotato di valvola di non-ritorno per un'efficace azione di inserimento dell'olio senza perdite
- portata: 70 cc a pompa
- capacità serbatoio: 7,5 litri
- massima viscosità olio utilizzabile: SAE 140

12 ADATTATORI		
FORD		AT-101
UNIVERSAL (Bmw, Honda, Nissan...)		AT-102
VW-AUDI		AT-103
VW-AUDI-PORSCHE		AT-104
VW-AUDI-MINI COOPER		AT-105
MERCEDES		AT-106
DSG		AT-107
VW-AUDI CVT		AT-108
VOLVO		AT-109
TOYOTA-LEXUS		AT-110
SKODA		AT-111
VW Passat/Tiguan <2007		AT-112



018840010 4,8 kg

~~€ 390,00~~ € 227,00



CB52-0

Carrello per cambi/trasmissioni con recupero liquidi

Il piano inclinato e i fori di scolo permettono il recupero dei liquidi direttamente nella vaschetta di raccolta

Dotato di:

- 4 ruote girevoli di cui 2 con freno
- cassetto per utensili
- vaschetta di raccolta liquidi estraibile in PE con capacità 7 litri
- 2 ripiani



052000201 60 kg

~~€ 520,00~~ € 295,00



Novità

Capacità 7 litri

870 mm
640 mm
1200 mm
Ø 100 mm

1493/C7 $\frac{3}{8}$ " \square 16 mm

Chiave autoregolabile a tre bracci per filtri olio destrorsa-sinistrorsa, con bracci intercambiabili

2 serie di bracci:

- 1 serie con lunghezza utile 20 mm
- 1 serie con lunghezza utile 38 mm

*Finitura
diamantata
antiscivolo*



210x150x50 mm

014930079 600 g

~~€ 92,50~~ € 53,50

Ø mm
50÷100

Novità

Chiavi autoserranti per filtri olio sinistrorse

1493/X1 $\frac{3}{8}$ "

014930105 280 g

~~€ 25,00~~ € 14,50

1493/X2 $\frac{3}{8}$ "

014930110 280 g

~~€ 25,00~~ € 14,50



	Ø mm	$\frac{+s}{-}$ mm
1493/X1	60÷80	2,9
1493/X2	80÷98	2,9

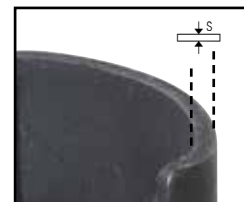

Chiavi autoserranti per filtri olio destrorse-sinistrorse, versione pesante

1493/Y1 $\frac{1}{2}$ "

014930120 300 g

~~€ 89,00~~ € 51,50

1493/Y2 $\frac{1}{2}$ "

014930122 1,2 kg

~~€ 136,00~~ € 78,50



	Ø mm	$\frac{+s}{-}$ mm
1493/Y1	80÷110	7,3
1493/Y2	104÷150	7,3

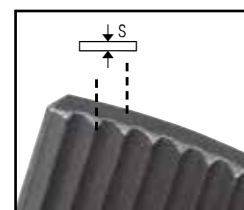

* L'articolo 1493Y/2 è utilizzabile anche per i filtri essiccatori

Recuperatori olio

- indicatore di livello
- coppa di grande diametro con griglia scolafiltro capacità 12l
- svuotamento pneumatico del serbatoio con tubo da 1,8 m
- vaschetta portautensili

1877

Recuperatore olio esausto carrellato con serbatoio da 90 litri



018770008 23 kg

~~€ 577,00~~ € 330,00

1877A

Recuperatore/aspiratore olio esausto, carrellato con serbatoio da 90 litri e precamera

- precamera trasparente capacità 9,5 l
- tubo aspirazione da 1,8 m

In dotazione:

- 1 sonda rigida Ø 5x700 mm
- 1 sonda flessibile Ø 5x700 mm
- 1 sonda rigida Ø 6x600 mm
- 1 sonda flessibile Ø 6x700 mm
- 1 sonda flessibile Ø 7x700 mm
- 1 sonda flessibile Ø 8x700 mm
- adattatori per VW, BMW, CITROËN, MERCEDES



018770080 29,5 kg

~~€ 1.000,00~~ € 575,00

1889 CF

Chiave universale per apertura fusti

- 1 esagono femmina Ø 38 mm
- 1 profilo a 4 settori Ø 42 mm
- 1 lama 17x7 mm

Novità



018890010 215 g

~~€ 27,00~~ € 15,50

1466/C5

Kit 5 chiavi per spurgo freni

Inclusi nel kit:

- 5 chiavi misura 7-8-9-10-11 mm
- 1 tubo di scarico con valvola di non ritorno

L'olio passa all'interno della bussola



260x170x50 mm

Non serve rimuovere la chiave per effettuare lo spurgo

014660100 700 g

~~€ 102,00~~ € 60,00

1471M/C22

Utensile pneumatico per arretrare e ruotare i pistoncini dei freni a disco destrorsi e sinistrorsi con accessori

- martinetto automatico
- 150 kg di spinta
- pressione di utilizzo 5÷8 bar



≡ 350x310x85 mm

014710101 3,8 kg

~~€ 247,00~~ € 143,00

1567

Leva per estrazione testine braccio oscillante e ammortizzatori dal montante

Un solo operatore riesce senza sforzo a posizionare la leva e a procedere al disassemblaggio



È sufficiente applicare una forza di 20 Nm



015670001 6,5 kg

~~€ 269,00~~ € 156,00

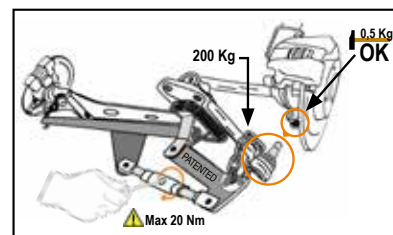
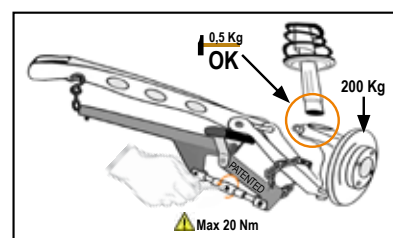

1530/C16

Kit a massa battente con colonnette distanziatrici, per estrazione mozzi e cuscinetti ruote a 3, 4, 5 fori

Il kit comprende:

- 1 flangia universale 90÷130 mm
- 1 massa battente da 5 kg
- 4 colonnette attacco M12
- 4 colonnette attacco M14



015300316 13,5 kg

~~€ 535,00~~ € 310,00

Ideale per mozzi con anello di centraggio sporgente

Novità



≡ 760x310x100 mm

1550U



Smonta ammortizzatori pneumatico per autoveicoli, SUV e veicoli commerciali

- sistema universale di presa superiore
- sistema di sicurezza attiva sulla molla
- griglia di protezione "full body"

Fornito di 2 staffe inferiori per diametri 78-205 mm

DATI TECNICI

Potenza spinta:

2 ton (10 bar) - 1.6 ton (8 bar) - 1.2 ton (6 bar)

Corsa di compressione molla: 335 mm

015500010 87,5 kg

€ 2.420,00 € 1.369,00



1550U/SS187

Staffa sinistrorsa per 1550U

particolarmente indicata per molle con profilo sinistro tipo Nissan Qashqai e Renault Koleos
Diametro 105-187 mm

015500018 4,4 kg

€ 302,00 € 175,00



1550U/M

Morsa per smonta ammortizzatori 1550U

permette il bloccaggio dello stelo dell'ammortizzatore

015500021 4 kg

€ 286,00 € 166,00



spinta massima 2 ton (10 bar)



1670 mm
670 mm
825 mm

720LC/C3



3 chiavi a bussola Macchina con inserti polimerici per dadi ruote

in valigetta di plastica

Ø: 17 - 19 - 21 mm



148x132x44 mm

007200653 800 g

€ 32,00 € 18,50

3009

Carrello per movimentazione veicoli

Portata massima: 550 kg

- 4 rulli basculanti
- larghezza rulli 200 mm
- per ruote fino a 240 mm di larghezza
- ruote in Vulkollan con cuscinetto



Ideale per:

- recupero vetture incidentate su carro attrezzi
- autofficine e carrozzerie
- movimentazione auto all'interno di show room

030090001 21,8 kg

€ 346,00 € 199,00

962P

Levagomme con protezione
in gomma antigraffio

Novità



009620049 750 g

~~€ 72,00~~ € 41,50



L mm	L1 mm
490	25

987AR

Levagomme con protezione
in gomma antigraffio

- fulcro in gomma e Nylon per cerchi in lega ed in ferro
- attacco rapido della valvola, non necessita di essere avvitata

Novità



009870021 200 g

~~€ 83,00~~ € 47,50



L mm
305

986PT

Giravite prearato 0,4 Nm
per valvole pneumatiche

Ritenzione automatica della valvola.
Il meccanismo di slittamento permette di non danneggiare la guarnizione del nucleo della valvola

Novità

*Particolarmente
indicato per
valvole TPMS*



009860140 30 g

~~€ 42,00~~ € 24,00

L mm	L1 mm
19	120

962M

Attrezzo per
smontaggio/montaggio
pneumatici

- ganasce antigraffio per bloccaggio su cerchi
- sede per inserimento leve smontagomme

Novità

*Montaggio Runflat
con tutti gli
smontagomme*



009620501 450 g

~~€ 260,00~~ € 149,00

3006 

Sollevatore e posizionario ruote trattori ed escavatori

- portata massima 1500 kg
- diametro ruota minimo 1000 mm
- diametro ruota massimo 2200 mm
- spessore ruota massimo 800 mm



030060000 120 kg

~~€ 1.460,00~~ **€ 849,00**



Novità

3035

Carrello trasporta pneumatici

- per trasportare agevolmente pneumatici fino ad un massimo di 980 mm di diametro
- utilizzabile come piano d'appoggio, grazie al blocco della posizione in orizzontale
- 2 ruote Ø 260 mm e 2 ruote Ø 125 mm
- altezza massima trasportabile 1,60 m
- portata massima 200 kg
- forche regolabili in 2 posizioni: 880 e 980 mm

030350100 30 kg

~~€ 798,00~~ **€ 460,00**



Novità

3010H

Cavalletti serie pesante



	C Max kg	H min mm	H Max mm	L mm	L1 mm	kg			
3010H 750	15000	450	750	300	300	22,5	030100150	€ 250,00	€ 146,00
3010H 1100	15000	650	1100	300	300	30	030100165	€ 315,00	€ 184,00

**3010V**Cavalletti serie pesante
con regolazione a vite

	C Max kg	H min mm	H Max mm	L mm	L1 mm	kg			
3010V 680	20000	470	680	300	300	27	030100200	€ 375,00	€ 219,00
3010V 1170	20000	680	1170	300	300	37,5	030100220	€ 480,00	€ 279,00

3025Gru idraulica pieghevole
con pompa a doppio effetto

- Portata massima 1 t
- la struttura richiudibile riduce al minimo gli ingombri
- 4 posizioni di carico: 450-650-800-1000 kg
- velocità di discesa controllata



030250001 110 kg

~~€ 1.570,00~~ **€ 906,00****3025/PF**Pinza movimentazione
fusti

030250011 10 kg

~~€ 252,00~~ **€ 145,00**

CE Sollevatori

	3030/2T	3065/20-10T	3065/40-20T	3067/60-15T	3067/70-13T
Portata	2 t	20-10 t	40 - 20 t	60-30-15 t	70 - 43 - 23 - 13 t
Alzata min./Max	85 - 520 mm	140 - 306 mm	150 - 300 mm	120 - 255 mm	150 - 400 mm
Valvole di discesa controllata	✓	✓	✓	✓	✓
Peso	45 kg	23 kg	39 kg	56 kg	74 kg
Indicato per					

3030/2T

Sollevatore idraulico a 6 ruote

- ottima manovrabilità del sollevatore su pavimentazioni sconnesse e irregolari
- doppie ruote anteriori basculanti in materiale plastico (PTFE)
- il pedale permette un rapido avvicinamento

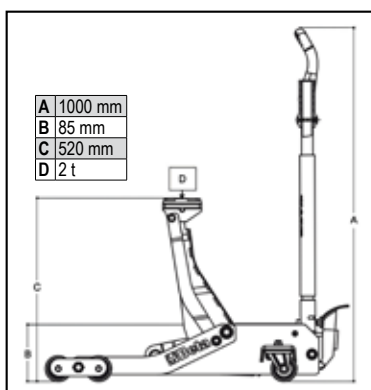

030300020 45 kg

€ 650,00 € 372,00

3065/20-10T

Sollevatore oleopneumatico 20-10 t con valigia di trasporto

- Portatile e leggero, ideale per gli interventi di assistenza su strada
- include due prolunghe da 75 e 60 mm

Novità

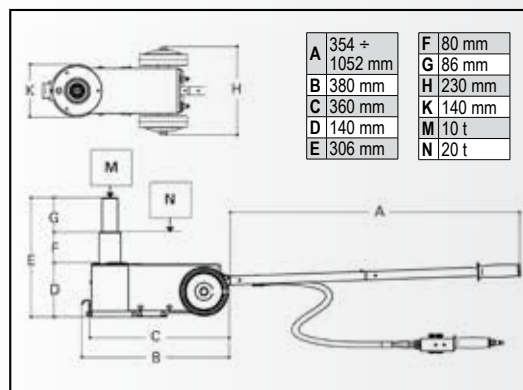

Ideale per gli interventi su strada



030650100 23 kg

€ 2.175,00 € 1.240,00



550x415x215 mm

3065/40-20T

Sollevatore oleopneumatico 40-20 t

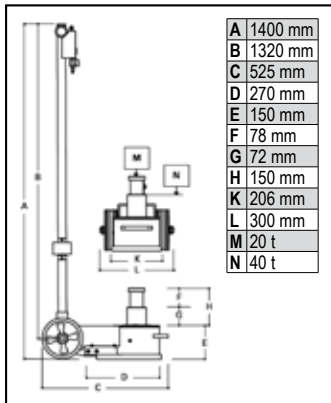

3067/60-15T

Sollevatore oleopneumatico 60-30-15 t

• include due prolunghe da 70 e 120 mm

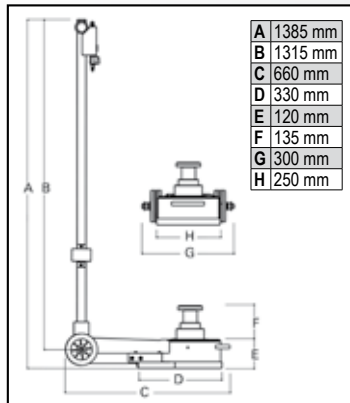

3067/70-13T

Sollevatore oleopneumatico 70-43-23-13 t

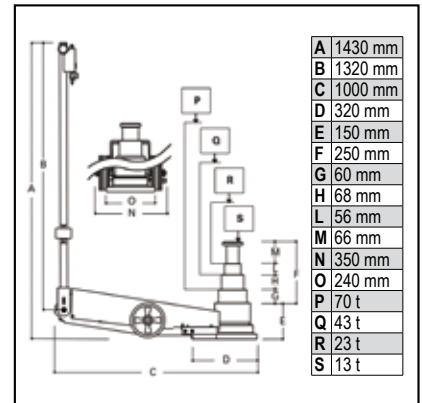

Novità

Ribassato per autobus e pullman



030650200 39 kg

€ 2.480,00 € 1.420,00



030670120 56 kg

€ 3.630,00 € 2.075,00



200 mm



030670130 74 kg

€ 4.590,00 € 2.625,00



3027 20 3027 30 3027 50

Capacità massima	20 t	30 t	50 t
Pompa manuale a 2 velocità	✓	✓	✓
Pistone mobile	✓	✓	✓
Sicurezza idraulica in caso di sovraccarico	✓	✓	✓
Manometro	✓	✓	✓
Serie prismi a V inclusi	✓	✓	✓
Argano	x	x	✓

CE *Presse idrauliche con pistone mobile*



3027 20

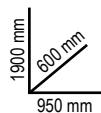

030270020 140 kg

€ 1.920,00 € 1.105,00



3027 30

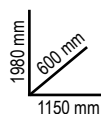

030270030 230 kg

€ 3.340,00 € 1.925,00



3027 50

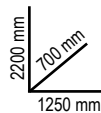

030270050 350 kg

€ 4.570,00 € 2.645,00



CE *Sollevatori idraulici da fossa e sottoponte*

3026 0,3 3026 0,5 3026 1,0

Portata massima	300 kg	500 kg	1000 kg
Pompa a pedale	✓	✓	✓
Altezza min/Max	1120 - 1970 mm	1140 - 1990 mm	1140 - 1990 mm
Valvola limitatrice di carico	✓	✓	✓

3026 0,3

030260003 24,7 kg

€ 575,00 € 332,00

3026 0,5

030260005 31 kg

€ 682,00 € 396,00

3026 1,0

030260010 37,8 kg

€ 827,00 € 473,00

3026/SP

Supporto universale per trasmissioni

- Permette ad un solo operatore di smontare e rimontare le trasmissioni di autovetture, veicoli commerciali e fuoristrada con rapidità e sicurezza.
- Adatto per steli con diametro: 25-30-35-45 mm
- Portata massima: 150 kg



030260505 7,8 kg

€ 560,00 € 324,00



3002**Letto sottomacchina e seggiolino**

- struttura in acciaio
- rivestimento in PVC con imbottitura
- possibilità di regolare la posizione rapidamente: letto o seggiolino



030020001 8 kg

~~€ 92,00~~ € 54,00

3003**Letto sottomacchina in plastica antiurto**

Ø ruote: 76 mm



030030001 5 kg

~~€ 71,50~~ € 41,50

2254T**Tappeto per protezione ginocchia**
Realizzato in EVA antiscivolo

022540047 200 g

~~€ 23,00~~ € 13,50

**2250-0****Seggiolino girevole con vassoio**

- Seduta tonda girevole
- Altezza regolabile tramite pistone a gas (410÷530 mm)
- 5 ruote pivotanti

2 portaminuterie/portautensili di cui uno regolabile in altezza



022500011 6 kg

~~€ 83,50~~ € 48,50

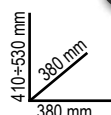
**2251-0****Seggiolino girevole con cassetti, vuoto**

- Seduta tonda girevole con altezza regolabile tramite pistone a gas (430÷560 mm)
- 4 ruote pivotanti

Base quadrata da 380 mm con 2 cassetti su un lato (350x180x40 mm) e 1 cassetto su altro lato (350x180x90 mm)



022510011 11,5 kg

~~€ 148,00~~ € 86,50

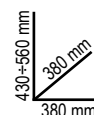

2258-0

Seggiolino con cassettera, vuoto

- Altezza totale 450 mm
- Vaschetta porta utensili frontale
- Vaschetta porta minuterie posteriore con separatori
- 4 ruote pivotanti



3 cassetti con guide telescopiche (320x195x60 mm)

022580011 10,2 kg

~~€ 150,00~~ € 87,50

Novità

2254F

Protezione anteriore auto

Permette di proteggere la parte frontale del veicolo lasciando le aperture per i fari e il radiatore

- Lavabile
- Impermeabile e resistente ad oli e grassi
- Fissaggio tramite lacci
- Materiale: 98% poliammide/nylon, 2% poliuretano



022540150 800 g

~~€ 68,50~~ € 40,00

2254SV

Protezione riutilizzabile per sedile e volante

Adatta alla maggior parte dei sedili e volanti di autoveicoli

- Misura unica
- Riutilizzabile e lavabile
- Realizzata in resistente tessuto di nylon con cordonatura elasticizzata
- Materiale: 98% poliammide/nylon, 2% poliuretano



022540100 170 g

~~€ 21,00~~ € 12,30

Novità

2254C

Protezione a ventosa per carrozzeria veicoli

In tessuto plastificato con 4 ventose sul lato superiore



022540200 200 g

~~€ 39,50~~ € 23,20

Novità

1365/K13

Pompa oleodinamica 10 t e kit accessori per carrozzeria in pratica valigia trolley

Inclusi nel kit:

- pompa oleodinamica 10T e pistone
- pinza divarica parafranghi e piastra di appoggio
- base a "L", punzoni e prolunghe
- raccordo maschio maschio per montaggio accessori



900x420x180 mm

013650013 33 kg

~~€ 543,00~~ € 308,00

1366/K5

Tirabolli pneumatico a massa battente da 1,1 kg

Inclusi nel kit:

- 1 ventosa Ø 75 mm
- 1 ventosa Ø 100 mm
- 1 ventosa Ø 125 mm
- 1 gancio



610x240x90 mm



Ventose a forte tenuta

013660010 4,5 kg

~~€ 186,00~~ € 107,00

1368 (CE)

Kit ripara plastiche

DESCRIZIONE TECNICA

- lunghezza cavo pistola termica 3,5 m
- 2 regolazioni di potenza 35-75 W
- pistola termica con terminali in ottone a 2 angolazioni di inserimento graffetta: 0°-90°
- protezione output: fusibile 10 A
- fornito senza graffette



Permette di riparare velocemente crepe e rotture di parti in plastica

013680001 3,7 kg

~~€ 339,00~~ € 196,50

1368G/K400

Assortimento di 400 graffette per 1368

In dotazione:

- 100 graffette a serpentina piccola
- 100 graffette a serpentina grande
- 100 graffette per angoli concavi
- 100 graffette per angoli convessi



013680140 255 g

~~€ 56,00~~ € 32,50

1366A

Attrezzo levabolli con kit di 19 funghetti di plastica

Da utilizzare con colla a caldo per superfici verniciate, 1851VK-12V.

Ideale per:

- bolli da grandine
- ammaccature causate da portiera
- piccole ammaccature in genere



013660200 600 g

~~€ 71,00~~ € 41,50

1367

Fustelle per installazione sensori di parcheggio

Fori perpendicolari e senza sbavature

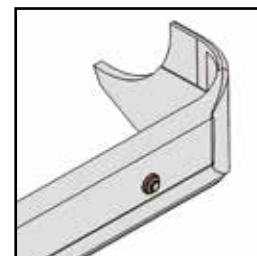
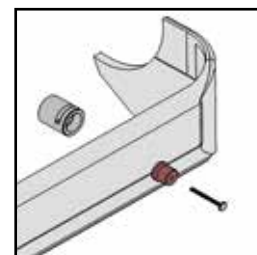

Novità

	Ø mm	N° pz	kg		
1367/S4	23-24 27-28	4	1	013670104	€ 175,00 € 102,00
1367/S6	17-18-19 20-21-22	6	1,2	013670100	€ 198,00 € 116,00



1366/KF

Kit di 19 funghetti di plastica per attrezzi levabolli



013660205 56 g

~~€ 26,00~~ € 15,20

1498PC

Stabilizzatore di tensione 12-24 V

Indispensabile per proteggere le centraline in fase di saldatura ed avviamenti con avviatori

12-24 V



014980801 300 g

~~€ 80,00~~ € 46,50

1366S **Spotter carrellato per carrozzeria**

- microprocessore per la gestione dei parametri di saldatura
- regolazione di potenza e tempo di saldatura
- campo di regolazione 400÷2200 Ah
- selettore punto singolo, pulsato, continuo
- tabella parametri di saldatura
- indicatore protezione termica
- pistola con attacco rapido
- tensione 230 V



20 kg

013660000 30 kg

~~€ 1.300,00~~ € 748,00**Pratica versione trolley**

400÷2200 Ah

**Novità****1366S-KIT****Kit accessori per spotter**

- 10 rondelle asolate
- 10 rondelle asolate a 90°
- 100 perni filettati 5x18 mm
- 100 perni autofilettanti 5x18 mm
- 100 perni autofilettanti 5x25 mm
- gancio per rondelle Ø 8x16x1,5 mm
- elettrodo per viti M5-M6
- elettrodo per rondelle asolate

013660001 1,4 kg

~~€ 172,00~~ € 99,00

250x170x35 mm

1366SL**Leva a tirare per ripristino lamiera**

Testina multigancio snodata per utilizzo con filo ondulato

Novità

L mm

74

013660002 1,3 kg

~~€ 150,00~~ € 86,00**1366ST****Traversa di tiro per ripristino lamiera**

Testina multigancio snodata per utilizzo con filo ondulato

Novità

013660003 4,1 kg

~~€ 480,00~~ € 275,00

L mm

85



1927B

Novità

Avvitatore reversibile

- Meccanismo impulsivo "Pin Clutch"
- Impugnatura in gomma
- Comando d'inversione a leva
- Tre differenti livelli di potenza in avvitamento
- Scarico dell'aria attraverso l'impugnatura

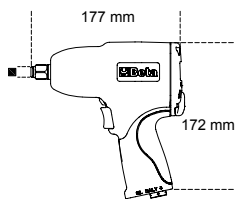

Velocità libera	giri/min	7.000
Massa battente		Pin Clutch
Coppia massima	Nm	705
Capacità vite/dado	Cl 8.8	M22●34 mm
Capacità vite/dado	Cl 12.9	M18●27 mm
Attacco aria	GAS	1/4"
Pressione di utilizzo	bar	6,2
Ø tubo consigliato	mm	10
Consumo aria medio	l/min	133
Peso	kg	2,1

 019270022 2,1 kg

~~€ 158,00~~ € 89,00

1927G

Novità

Avvitatore reversibile compatto

- Meccanismo impulsivo singolo martello
- Corpo motore in alluminio con impugnatura in materiale composito
- Comando d'inversione azionabile con una sola mano
- 3 differenti livelli di potenza in avvitamento
- Scarico dell'aria attraverso l'impugnatura
- Motore in testa con trasmissione diretta della rotazione al quadro d'uscita che permette di ottenere un miglior bilanciamento del corpo aumentando la maneggevolezza

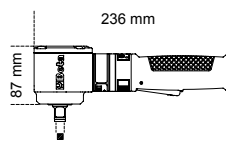

Velocità libera	giri/min	8.500
Massa battente		Singolo martello
Coppia massima	Nm	325
Capacità vite/dado	Cl 8.8	M16●24 mm
Capacità vite/dado	Cl 12.9	M14●21 mm
Attacco aria	GAS	1/4"
Pressione di utilizzo	bar	6,2
Ø tubo consigliato	mm	10
Consumo aria medio	l/min	113
Peso	kg	1,2

 019270050 1,2 kg

~~€ 350,00~~ € 203,00

720S/SB6

 007200906 456 g

~~€ 46,00~~ € 26,80

Serie di 6 chiavi a bussola Macchina compatte con attacco quadro femmina 1/2", con guida appendibile



1927XM/K5

Avvitatore reversibile compatto fornito con 5 bussole Macchina, in valigetta di plastica

- Meccanismo impulsivo singolo martello
- Incredibilmente compatto e potente
- Comando d'inversione a pulsante azionabile con una sola mano
- Tre differenti livelli di potenza in avvitamento
- Scarico dell'aria attraverso l'impugnatura
- Gancio per bilanciatore

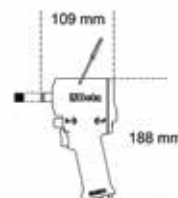

 720 17-19-21-22-24 mm

Velocità libera	giri/min	10.000
Massa battente		Singolo martello
Coppia massima	Nm	770
Capacità vite/dado	Cl 8.8	M22●34 mm
Capacità vite/dado	Cl 12.9	M18●27 mm
Attacco aria	GAS	1/4"
Pressione di utilizzo	bar	6,2
Ø tubo consigliato	mm	10
Consumo aria medio	l/min	122
Peso	kg	1,3

 019270129 1,3 kg

~~€ 289,00~~ € 166,00

 307x206x86 mm

1927CD/K3

Avvitatore reversibile, in materiale composito fornito con 3 bussole Macchina, in valigetta di plastica

- Meccanismo impulsivo doppio martello
- Leggero e bilanciato per un facile utilizzo
- Dotato di un'elevata coppia
- Comando d'inversione a leva
- Tre differenti livelli di potenza in avvitamento
- Scarico dell'aria attraverso l'impugnatura
- Silenziato

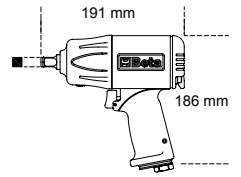

720LC 17-19-21 mm

Velocità libera	giri/min	7.000
Massa battente		Doppio martello
Coppia massima	Nm	1020
Capacità vite/dado	Cl 8.8	M22●34 mm
Capacità vite/dado	Cl 12.9	M18●27 mm
Attacco aria	GAS	1/4"
Pressione di utilizzo	bar	6,2
Ø tubo consigliato	mm	10
Consumo aria medio	l/min	130
Peso	kg	1,9

019270107 1,9 kg

~~€ 405,00~~ **€ 209,00**

350x305x86 mm

1927P

Avvitatore reversibile in materiale composito

- Meccanismo impulsivo doppio martello
- Leggero e bilanciato per un facile utilizzo
- Comando d'inversione a leva
- Tre differenti livelli di potenza in avvitamento
- Scarico dell'aria attraverso l'impugnatura
- Impugnatura antivibrazioni

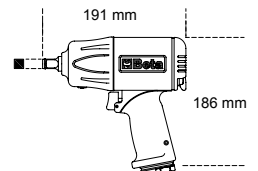

**Super potente
1750 Nm**

Velocità libera	giri/min	7.500
Massa battente		Doppio martello
Coppia massima	Nm	1750
Capacità vite/dado	Cl 8.8	M24●36 mm
Capacità vite/dado	Cl 12.9	M20●30 mm
Attacco aria	GAS	1/4"
Pressione di utilizzo	bar	6,2
Ø tubo consigliato	mm	10
Consumo aria medio	l/min	290
Peso	kg	2

019270008 2 kg

~~€ 423,00~~ **€ 245,00**



1928K4

Avvitatore reversibile fornito con 4 bussole Macchina serie lunga, in valigetta di plastica

- Meccanismo multiplo "Pin Clutch"
- Tre differenti livelli di potenza in avvitamento e svitamento
- Impugnatura antiscivolo
- Comando d'inversione a leva
- Scarico dell'aria attraverso l'impugnatura

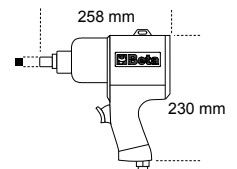

728L 27-30-32-36 mm

Velocità libera	giri/min	4.000
Massa battente		Pin Clutch
Coppia massima	Nm	1.493
Capacità vite/dado	Cl 8.8	M27●41 mm
Capacità vite/dado	Cl 12.9	M24●36 mm
Attacco aria	GAS	3/8"
Pressione di utilizzo	bar	6,2
Ø tubo consigliato	mm	10
Consumo aria medio	l/min	260
Peso	kg	5,2

019280104 5,2 kg

~~€ 690,00~~ **€ 395,00**



410x330x106 mm

1928DA

Avvitatore reversibile

- Meccanismo impulsivo doppio martello
- Robusto e compatto, dotato di un'elevata coppia
- Comando d'inversione a leva
- Tre differenti livelli di potenza in avvitamento e svitamento
- Scarico dell'aria attraverso l'impugnatura
- Impugnatura ergonomica antiscivolo

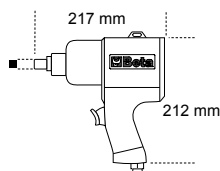

Velocità libera	giri/min	5.000
Massa battente		Doppio martello
Coppia massima	Nm	1.695
Capacità vite/dado	Cl 8.8	M27●41 mm
Capacità vite/dado	Cl 12.9	M24●36 mm
Attacco aria	GAS	3/8"
Pressione di utilizzo	bar	6,2
Ø tubo consigliato	mm	10
Consumo aria medio	l/min	210
Peso	kg	4,3

019280022 4,3 kg

~~€ 678,00~~ € 389,00



1928CD

Avvitatore reversibile

- Meccanismo impulsivo doppio martello
- Robusto e compatto, dotato di un'elevata coppia
- Comando d'inversione a leva
- Tre differenti livelli di potenza in avvitamento e svitamento
- Scarico dell'aria attraverso l'impugnatura
- Impugnatura ergonomica antiscivolo

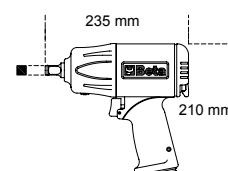

Velocità libera	giri/min	4.500
Massa battente		Doppio martello
Coppia massima	Nm	1.800
Capacità vite/dado	Cl 8.8	M27●41 mm
Capacità vite/dado	Cl 12.9	M24●36 mm
Attacco aria	GAS	3/8"
Pressione di utilizzo	bar	6,2
Ø tubo consigliato	mm	10
Consumo aria medio	l/min	215
Peso	kg	3,5

019280007 3,5 kg

~~€ 870,00~~ € 497,00



1930PA

Avvitatore reversibile

- Estremamente compatto
- Dotato di maniglia ausiliaria
- Comando d'inversione a leva
- Tre differenti livelli di potenza in avvitamento e svitamento
- Scarico dell'aria attraverso l'impugnatura

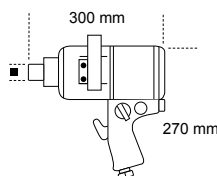

Velocità libera	giri/min	3.500
Massa battente		Doppio martello
Coppia massima	Nm	2445
Capacità vite/dado	Cl 8.8	M36●55mm
Capacità vite/dado	Cl 12.9	M30●46mm
Attacco aria	GAS	1/2"
Pressione di utilizzo	bar	6,2
Ø interno tubo aria	mm	13
Consumo aria medio	l/min	350
Peso	kg	9,6

019300032 9,6 kg

~~€ 1.040,00~~ € 579,00



1930ZL

Avvitatore reversibile

- Dotato di maniglia ausiliaria
- Comando d'inversione a leva
- Quattro differenti livelli di potenza in avvitamento e svitamento
- Scarico dell'aria posto nella parte superiore del corpo

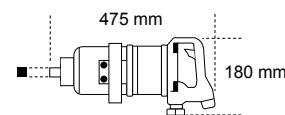

Velocità libera	giri/min	3.000
Massa battente		Doppio martello
Coppia massima	Nm	4.068
Capacità vite/dado	Cl 8.8	M42●65 mm
Capacità vite/dado	Cl 12.9	M36●55 mm
Attacco aria	GAS	1/2"
Pressione di utilizzo	bar	6,2
Ø interno tubo aria	mm	13
Consumo aria medio	l/min	480
Peso	kg	15

019300070 15 kg

~~€ 1.875,00~~ € 1.070,00



**Alta coppia
4068 Nm**

1930LH

Avvitatore reversibile

- Meccanismo impulsivo doppio martello
- Albero da 210 mm (8,3")
- Impugnatura con nuovo design, inclinata di 70° per non affaticare il polso
- Dotato di maniglia ausiliaria laterale
- 3 differenti livelli di potenza in avvitamento e svitamento
- Scarico dell'aria posto nella parte inferiore del corpo

Ottimo rapporto peso/potenza



Velocità libera	giri/min	6.000
Massa battente		Doppio martello
Coppia massima	Nm	2.441
Capacità vite/dado	Cl 8.8	M36 ● 55 mm
Capacità vite/dado	Cl 12.9	M30 ● 46 mm
Attacco aria	GAS	1/2"
Pressione di utilizzo	bar	6,2
Ø tubo consigliato	mm	13
Consumo aria medio	l/min	280
Peso	kg	7,1

019300030 7,1 kg

~~€ 1.080,00~~ € 619,00

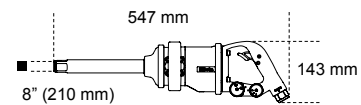

1930LA

Avvitatore reversibile

- Meccanismo impulsivo doppio martello
- Albero da 8" (203 mm)
- Dotato di maniglia ausiliaria
- Comando d'inversione a leva
- 3 differenti livelli di potenza in avvitamento
- Scarico dell'aria attraverso l'impugnatura



Velocità libera	giri/min	4.000
Massa battente		Doppio martello
Coppia massima	Nm	2.445
Capacità vite/dado	Cl 8.8	M36 ● 55 mm
Capacità vite/dado	Cl 12.9	M30 ● 46 mm
Attacco aria	GAS	1/2"
Pressione di utilizzo	bar	6,2
Ø tubo consigliato	mm	13
Consumo aria medio	l/min	460
Peso	kg	10,6

019300037 10,6 kg

~~€ 1.055,00~~ € 595,00

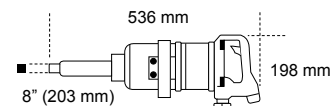

1937

Levigatrice rotorbitale palmare senza lubrificazione in composito

- Non necessita di lubrificazione
- Estremamente compatta e maneggevole
- Platorello con velcro a 6 fori, Ø 150 mm
- Regolazione in continuo della velocità del motore
- Impugnatura in morbido materiale antiscivolo
- Predisposta per la connessione a sistemi di aspirazione con raccordo girevole
- Scarico dell'aria orientabile

*Diametro orbita
2,5 mm
5,0 mm*

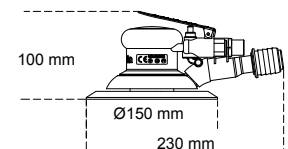

Velocità libera	giri/min	12.000
Potenza	kW	0,18
Dimensione platorello	mm	150
Filettatura albero		5/16"-24
Attacco aria	GAS	1/4"
Pressione di utilizzo	bar	6,2
Ø interno tubo aria	mm	10
Consumo aria medio	l/min	170
Peso	g	860

Novità

		Ø Orbita		
1937 2,5	019370000	2,5 mm	€ 379,00	€ 217,00
1937	019370001	5,0 mm	€ 379,00	€ 217,00



Novità

1924F  

Avvitatore reversibile compatto "butterfly"

- Meccanismo impulsivo tipo "rocking dog" con doppio martello
- Ergonomico e compatto per un facile utilizzo in spazi ristretti e difficilmente raggiungibili
- Estremamente leggero e maneggevole
- Comando d'inversione tramite leva basculante tipo "butterfly"
- 3 differenti livelli di potenza in avvitamento e svitamento
- Rapporto peso/potenza molto vantaggioso: permette di raggiungere coppie pari a 108 Nm

Compatto e potente
108 Nm



139 mm

Velocità libera	giri/min	12.000
Coppia massima	Nm	108
Capacità vite/dado	Cl 8.8	M12●18mm
Capacità vite/dado	Cl 12.9	M10●16mm
Attacco aria	GAS	1/4"
Pressione di utilizzo	bar	6,2
Ø interno tubo aria	mm	10
Consumo aria medio	l/min	59
Peso	kg	0,5

 **019240025** 0,5 kg

~~€ 200,00~~ **€ 115,00**



Gricchetti reversibili a massa battente

- Meccanismo impulsivo tipo "rocking dog" con doppio martello
- Facilità di serraggio: il sistema a massa battente elimina la torsione del polso a fine avvitatura e riduce i tempi operativi
- Compatto e potente: la coppia massima raggiungibile è notevolmente superiore rispetto a quella ottenibile con un cricchetto tradizionale
- Impugnatura ergonomica in gomma

68 Nm



164 mm

1922P1  

 **019220006** 0,6 kg

~~€ 245,00~~ **€ 125,00**

1922P2  

 **019220010** 0,6 kg

~~€ 245,00~~ **€ 125,00**

Velocità libera	giri/min	700
Coppia massima	Nm	68
Capacità vite/dado	Cl 8.8	M10●16 mm
Capacità vite/dado	Cl 12.9	M8●13 mm
Attacco aria	GAS	1/2"
Pressione di utilizzo	bar	6,2
Ø interno tubo aria	mm	10
Consumo aria medio	l/min	88
Peso	kg	0,6

Novità

Coppie elevate senza contraccolpi sul polso

136 Nm



292 mm

1922P3  

 **019220013** 1,5 kg

~~€ 342,00~~ **€ 198,00**



Velocità libera	giri/min	600
Coppia massima	Nm	136
Capacità vite/dado	Cl 8.8	M12●18 mm
Capacità vite/dado	Cl 12.9	M10●16 mm
Attacco aria	GAS	1/2"
Pressione di utilizzo	bar	6,2
Ø interno tubo aria	mm	10
Consumo aria medio	l/min	113
Peso	kg	1,5

1942A

Seghetto alternativo

- Potente e maneggevole
- Ideale per tagliare carrozzerie, scarichi e marmitte, alluminio e plastica
- Dotato di impugnatura in gomma, tubo di scarico in PVC e tubo di alimentazione raccordato
- Scarico dell'aria posteriore

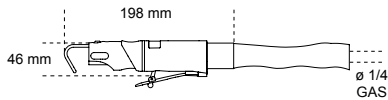

Corse al minuto		10.000
Lunghezza della corsa	mm	10
Attacco aria	GAS	1/4"
Pressione di utilizzo	bar	6,2
Ø interno tubo aria	mm	8
Consumo aria medio	l/min	75
Peso	g	550

019420000 550 g

€ 263,00 € 151,00

1946C4,8

Rivettatrice con aspirazione automatica

- Per impiego con rivetti in acciaio, acciaio inox, alluminio e rame, da 2,4 - 3,2 - 4,0 - 4,8 mm
- Becco conico a punta
- Potente e maneggevole, con impugnatura in composito
- Completa di serbatoio portasteli

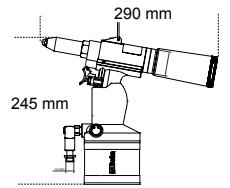

Materiale/rivetto	2,4	3,2	4	4,8
Rame	✓	✓	✓	✓
Alluminio	✓	✓	✓	✓
Acciaio	✓	✓	✓	✓
Acciaio Inox	✓	✓	✓	✓

Potenza di trazione	N	8.900
Lunghezza della corsa	mm	15
Capacità massima rivetti	Ø acciaio inox	4,8 mm
Attacco aria	GAS	1/4"
Pressione di utilizzo	bar	6,2
Ø interno tubo aria	mm	10
Consumo aria	l/ciclo	2,6
Peso	kg	1,5

019460006 1,5 kg

€ 495,00 € 285,00



1933I

Smerigliatrice assiale

- Indicata per lavori gravosi e prolungati grazie all'elevata potenza
- Corpo ed impugnatura in materiale antiscivolo
- Montata su cuscinetti a sfera
- Regolatore di velocità mediante manopola
- Attacco aria girevole
- Scarico dell'aria posteriore silenziato
- Leva di sicurezza a scatto
- Fornita con pinza da 3 e 6 mm

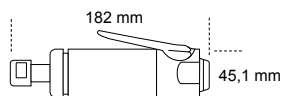

Velocità libera	giri/min	20.000
Capacità pinza	mm	3-6
Potenza	kW	0,38
Attacco aria	GAS	1/4"
Pressione di utilizzo	bar	6,2
Ø interno tubo aria	mm	10
Consumo aria medio	l/min	260
Peso	g	670



019330005 670 g

€ 128,00 € 73,00

1944A

Scrostatore ad aghi assiale

- Possibilità di regolare la fuoriuscita degli aghi variando la posizione del tubo
- Adatto alla rimozione di ruggine e vernici
- Il design assiale permette di agire in spazi ristretti
- Dotato di 19 aghi (Ø 3 mm)
- Possibilità di montare kit 28 aghi (Ø 2 mm)

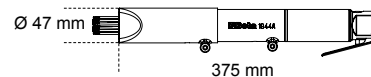

Colpi al minuto	BPM	3.800
Corsa del pistone	mm	33
N. aghi	mm	19
Ø aghi	mm	3
Attacco aria	GAS	1/4"
Pressione di utilizzo	bar	6,2
Ø interno tubo aria	mm	8
Consumo aria medio	l/min	85
Peso	kg	2,8

019440011 2,8 kg

€ 298,00 € 172,00

1945C

Graffettatrice, groppinatrice combinata

- Impugnatura rivestita in gomma
- Corpo leggero in alluminio
- Scarico dell'aria orientabile a 360°
- Sicurezza sul puntale
- Meccanismo di disincepimento
- **Campi di impiego: costruzione telai in legno e casse di imballaggio, applicazione rivestimenti ed isolanti, fissaggio battiscopa e cornici ferma vetro.**
- Utilizza graffette tipo 90 sezione 1,25 x 1,0 mm (18 Gauge), lunghezza 16 - 40 mm, larghezza 5,8 mm
- Utilizza groppini tipo B12 sezione 1,25 x 1,0 mm (18 Gauge), lunghezza 15 - 50 mm, testa da 1,9 mm



Novità

019450200 1,1 kg

~~€ 210,00~~ **€ 119,50**

Capacità caricatore	pz.	100
Attacco aria	GAS	1/4"
Pressione di utilizzo	bar	5-8
Ø interno tubo aria	mm	8
Consumo aria (7 bar)	l/ciclo	1,12
Peso	kg	1,1

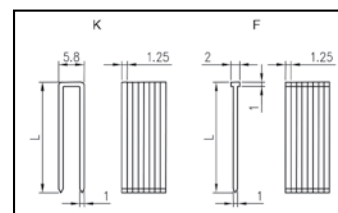

1945S

Graffettatrice

- Impugnatura rivestita in gomma
- Corpo leggero in alluminio
- Scarico dell'aria orientabile a 360°
- Sicurezza sul grilletto
- **Campi di impiego: settore calzaturiero, produzione e finitura mobili, cornici, costruzione di porte e finestre, allestimenti fieristici, cucitura di sacchetti**
- Utilizza graffette tipo 80, sezione 0,95 x 0,65 mm (21 Gauge), lunghezza 4 - 16 mm, larghezza 12,8 mm



Novità

019450000 870 g

~~€ 160,00~~ **€ 92,50**

Capacità caricatore	pz.	157
Attacco aria	GAS	1/4"
Pressione di utilizzo	bar	4,2-7
Ø interno tubo aria	mm	8
Consumo aria (7 bar)	l/ciclo	0,34
Peso	g	870

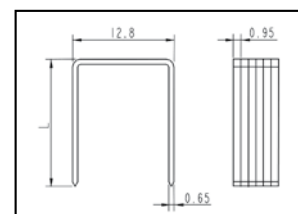

1945P

Spillatrice

- Impugnatura rivestita in gomma
- Corpo leggero in alluminio
- Sicurezza sul grilletto
- **Campi di impiego: fissaggi invisibili, finiture mobili, realizzazione cornici, fissaggio coprifili**
- Utilizza spilli tipo B6, Ø 0,64 mm (23 Gauge), lunghezza 12 - 35 mm



Novità

019450100 870 g

~~€ 258,00~~ **€ 148,00**

Capacità caricatore	pz.	145
Attacco aria	GAS	1/4"
Pressione di utilizzo	bar	4-7
Ø interno tubo aria	mm	8
Consumo aria (7 bar)	l/ciclo	0,27
Peso	g	870

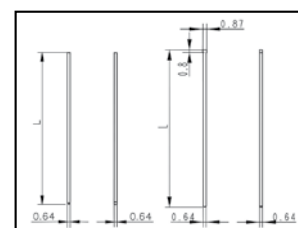

Avvolgitubo automatici

- Corpo in materiale plastico antiurto per aria compressa o acqua fredda
- Staffa di fissaggio metallica, orientabile
- Dispositivo automatico di arresto del tubo alla lunghezza desiderata

1901T/10 1901BM/8

Attacco aria	GAS	3/8"	1/4"
Lunghezza tubo	m	15+1	9+1
Pressione massima di utilizzo	bar	15	12
Ø interno tubo aria	mm	10	8
Materiale Tubo		PVC	Poliuretano

1901T/10

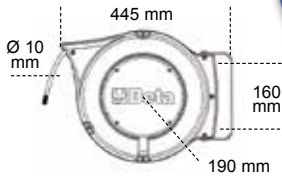

019010210 6,5 kg
~~€ 260,00~~ € 149,50

1901BM/8

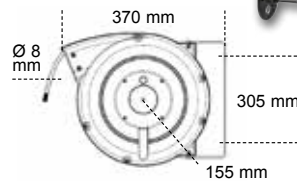

019010111 3,5 kg
~~€ 219,00~~ € 126,00

1947M

Pistola per sigillanti monocomponente

- Pistola pneumatica per l'estrusione e la spruzzatura di prodotti sigillanti monocomponente, cartucce a base polimerica e poliuretana, prodotti protettivi e insonorizzanti
- Utilizzabile con cartucce in plastica da 310 ml; connessione a pressione
- Fornita con kit ugelli d'estrusione, per la realizzazione di cordoni di diversa geometria
- La polverizzazione e la quantità di prodotto spruzzato possono essere facilmente regolate, ottenendo superfici più o meno bucciate e cordoni di diversa larghezza e spessore



Novità



Dimensione del tubo	mm	210x50
Capacità della cartuccia	ml	310
Attacco aria	GAS	1/4"
Pressione di utilizzo	bar	3 ÷ 5
Ø ugelli	mm	1,6 - 2,5
Consumo aria medio	l/min	250
Peso	kg	1,2

019470021 1,2 kg
~~€ 270,00~~ € 155,00

1949GPE

Pistola per gonfiaggio pneumatici

- Pressione di esercizio: 0÷11 bar (0÷160 psi)
- Funzione di scarico pressione
- Funzione di sola misurazione della pressione
- Manometro rivestito in gomma antiurto
- Rotazione del tubo a 360°

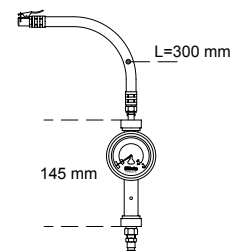

019490008 640 g
~~€ 108,00~~ € 62,50

NUOVA LINEA "BASIC"

Da oggi prodotte con lamina antiperforazione in fibra composita: **MAGGIORE FLESSIBILITA' = MAGGIOR COMFORT**



7241CK (CE)

Scarpe in pelle idrorepellente

- Puntale in acciaio
- Lamina antiperforazione in fibra composita

EU	UK	Art.
35	2,5	072411535
36	3,5	072411536
37	4,5	072411537
38	5	072411538
39	6	072411539
40	6,5	072411540
41	7	072411541
42	8	072411542
43	9	072411543
44	10	072411544
45	10,5	072411545
46	11	072411546
47	12	072411547
48	13	072411548



EN ISO 20345 2011

S3 SRC

~~€ 39,00~~ € 22,30

7243CK (CE)

Scarpe alte in pelle idrorepellente con rapido sfilamento

- Puntale in acciaio
- Lamina antiperforazione in fibra composita

EU	UK	Art.
35	2,5	072431335
36	3,5	072431336
37	4,5	072431337
38	5	072431338
39	6	072431339
40	6,5	072431340
41	7	072431341
42	8	072431342
43	9	072431343
44	10	072431344
45	10,5	072431345
46	11	072431346
47	12	072431347
48	13	072431348



EN ISO 20345 2011

S3 RS SRC

~~€ 40,00~~ € 22,80

RAPIDO SFILAMENTO

7245BK (CE)

Scarpe alte "saldatore" stringate in pelle idrorepellente con rapido sfilamento e protezione frontale con chiusura a strappo

- Puntale in acciaio
- Lamina antiperforazione in fibra composita

EU	UK	Art.
35	2,5	072451235
36	3,5	072451236
37	4,5	072451237
38	5	072451238
39	6	072451239
40	6,5	072451240
41	7	072451241
42	8	072451242
43	9	072451243
44	10	072451244
45	10,5	072451245
46	11	072451246
47	12	072451247
48	13	072451248



EN ISO 20345 2011

S3 RS SRC

~~€ 46,50~~ € 26,50

RAPIDO SFILAMENTO

7246BK (CE)

Scarpe in pelle scamosciata traforata

- Puntale in acciaio
- Lamina antiperforazione in fibra composita

EU	UK	Art.
35	2,5	072461235
36	3,5	072461236
37	4,5	072461237
38	5	072461238
39	6	072461239
40	6,5	072461240
41	7	072461241
42	8	072461242
43	9	072461243
44	10	072461244
45	10,5	072461245
46	11	072461246
47	12	072461247
48	13	072461248



EN ISO 20345 2011

S1P SRC

~~€ 40,00~~ € 22,80

**NUOVA LINEA
"EASY PLUS"**



7220PEK (CE)

Scarpe in pelle idrorepellente con inserti in nylon e rinforzo antiabrasione nella zona del puntale

- Puntale in composito
- Lamina antiperforazione in fibra composita

EU	UK	
35	2,5	072200235
36	3,5	072200236
37	4,5	072200237
38	5	072200238
39	6	072200239
40	6,5	072200240
41	7	072200241
42	8	072200242
43	9	072200243
44	10	072200244
45	10,5	072200245
46	11	072200246
47	12	072200247
48	13	072200248



EN ISO 20345 2011

S3 SRC

~~€ 53,00~~ € 30,50

7221PEK (CE)

Scarpe alte in pelle idrorepellente con inserti in nylon, rinforzo antiabrasione nella zona del puntale e rapido sfilamento

- Puntale in composito
- Lamina antiperforazione in fibra composita

EU	UK	
35	2,5	072210235
36	3,5	072210236
37	4,5	072210237
38	5	072210238
39	6	072210239
40	6,5	072210240
41	7	072210241
42	8	072210242
43	9	072210243
44	10	072210244
45	10,5	072210245
46	11	072210246
47	12	072210247
48	13	072210248



EN ISO 20345 2011

S3 RS SRC

~~€ 55,00~~ € 31,50

RAPIDO SFILAMENTO

7223PEK (CE)

Scarpe in pelle scamosciata con inserti in mesh ad alta traspirazione e rinforzo antiabrasione nella zona del puntale

- Puntale in composito
- Lamina antiperforazione in fibra composita

EU	UK	
35	2,5	072230135
36	3,5	072230136
37	4,5	072230137
38	5	072230138
39	6	072230139
40	6,5	072230140
41	7	072230141
42	8	072230142
43	9	072230143
44	10	072230144
45	10,5	072230145
46	11	072230146
47	12	072230147
48	13	072230148



EN ISO 20345 2011

S1P SRC

~~€ 54,00~~ € 31,00

7224PEK (CE)

Scarpe in pelle scamosciata traforata con rinforzo antiabrasione nella zona del puntale

- Puntale in composito
- Lamina antiperforazione in fibra composita

EU	UK	
35	2,5	072240235
36	3,5	072240236
37	4,5	072240237
38	5	072240238
39	6	072240239
40	6,5	072240240
41	7	072240241
42	8	072240242
43	9	072240243
44	10	072240244
45	10,5	072240245
46	11	072240246
47	12	072240247
48	13	072240248



EN ISO 20345 2011

S1P SRC

~~€ 54,00~~ € 31,00

7249G (CE)

Scarpe in pelle scamosciata con inserti in mesh

- Puntale in acciaio
- Lamina antiperforazione in acciaio elastico

EU	UK	
35	2,5	072490135
36	3,5	072490136
37	4,5	072490137
38	5	072490138
39	6	072490139
40	6,5	072490140
41	7	072490141
42	8	072490142
43	9	072490143
44	10	072490144
45	10,5	072490145
46	11	072490146
47	12	072490147
48	13	072490148



EN ISO 20345 2011

S1P SRC

~~€ 50,50~~ € 28,90

7236B (CE)

Scarpe in action nabuk idrorepellente con inserti in nylon

- Puntale in acciaio
- Lamina antiperforazione in acciaio elastico

EU	UK	
35	2,5	072360235
36	3,5	072360236
37	4,5	072360237
38	5	072360238
39	6	072360239
40	6,5	072360240
41	7	072360241
42	8	072360242
43	9	072360243
44	10	072360244
45	10,5	072360245
46	11	072360246
47	12	072360247
48	13	072360248



EN ISO 20345 2011

S3 SRC

~~€ 64,50~~ € 37,00

7310CRK (CE)

Scarpe "saldatore" stringate in pelle stampata idrorepellente

- Puntale in composito
- Lamina antiperforazione in fibra composita
- Rapido sfilamento
- Protezione frontale con chiusura a strappo e cuciture antifiama
- Inserto antiabrasione nella zona del puntale
- Suola in gomma ad alta resistenza

Novità

EU	UK	
35	2,5	073100335
36	3,5	073100336
37	4,5	073100337
38	5	073100338
39	6	073100339
40	6,5	073100340
41	7	073100341
42	8	073100342
43	9	073100343
44	10	073100344
45	10,5	073100345
46	11	073100346
47	12	073100347
48	13	073100348

RAPIDO SFILAMENTO



EN ISO 20345 2011

S3 RS HRO SRC

~~€ 73,00~~ € 41,90

Suola in gomma

7238WR (CE)

Scarpe alte in pelle scamosciata con inserti in nylon, suola in gomma ad alta resistenza e rapido sfilamento Calzatura WR resistente all'acqua

- Puntale in composito
- Lamina antiperforazione in fibra composita

Endurance

EU	UK	
35	2,5	072380235
36	3,5	072380236
37	4,5	072380237
38	5	072380238
39	6	072380239
40	6,5	072380240
41	7	072380241
42	8	072380242
43	9	072380243
44	10	072380244
45	10,5	072380245
46	11	072380246
47	12	072380247
48	13	072380248

RAPIDO SFILAMENTO



EN ISO 20345 2011

S3 RS WR HRO SRC

~~€ 82,00~~ € 46,00

Suola in gomma

FLEX

Estremamente flessibili e leggere (peso indicativo misura 42: \hat{m} 450 g)

7212FG (CE)

Scarpe in pelle scamosciata traforata con inserto antiabrasione nella zona del puntale

- Puntale in composito
- Lamina antiperforazione in fibra composita
- Suola in poliuretano monodensità

EU	UK	
35	2,5	072120035
36	3,5	072120036
37	4,5	072120037
38	5	072120038
39	6	072120039
40	6,5	072120040
41	7	072120041
42	8	072120042
43	9	072120043
44	10	072120044
45	10,5	072120045
46	11	072120046
47	12	072120047
48	13	072120048

7213FG (CE)

Scarpe in pelle scamosciata con inserti in mesh ad alta traspirazione

- Puntale in composito
- Lamina antiperforazione in fibra composita
- Suola in poliuretano monodensità

EU	UK	
35	2,5	072130035
36	3,5	072130036
37	4,5	072130037
38	5	072130038
39	6	072130039
40	6,5	072130040
41	7	072130041
42	8	072130042
43	9	072130043
44	10	072130044
45	10,5	072130045
46	11	072130046
47	12	072130047
48	13	072130048



EN ISO 20345 2011

S1P SRC

€ 59,00

€ 34,00

€ 59,00

€ 34,00

7214FN (CE)

Scarpe in action nabuk idrorepellente con inserto antiabrasione nella zona del puntale

- Puntale in composito
- Lamina antiperforazione in fibra composita
- Suola in poliuretano monodensità

EU	UK	
35	2,5	072140035
36	3,5	072140036
37	4,5	072140037
38	5	072140038
39	6	072140039
40	6,5	072140040
41	7	072140041
42	8	072140042
43	9	072140043
44	10	072140044
45	10,5	072140045
46	11	072140046
47	12	072140047
48	13	072140048

7218FN (CE)

Scarpe in action nabuk idrorepellente con inserto antiabrasione nella zona del puntale

- Puntale in composito
- Lamina antiperforazione in fibra composita

Novità

EU	UK	
35	2,5	072180035
36	3,5	072180036
37	4,5	072180037
38	5	072180038
39	6	072180039
40	6,5	072180040
41	7	072180041
42	8	072180042
43	9	072180043
44	10	072180044
45	10,5	072180045
46	11	072180046
47	12	072180047
48	13	072180048

RAPIDO SFILAMENTO



EN ISO 20345 2011

S3 SRC

€ 64,00

€ 36,80

€ 66,00

€ 38,00

Scarpe in pelle scamosciata traforata

- Puntale in composito
- Lamina antiperforazione in fibra composita

7210PB (CE)

Misano

EU	UK	Articolo
35	2,5	072100435
36	3,5	072100436
37	4,5	072100437
38	5	072100438
39	6	072100439
40	6,5	072100440
41	7	072100441
42	8	072100442
43	9	072100443
44	10	072100444
45	10,5	072100445
46	11	072100446
47	12	072100447
48	13	072100448



~~€ 68,00~~ € 38,80

7211PG (CE)

Mugello

EU	UK	Articolo
35	2,5	072110435
36	3,5	072110436
37	4,5	072110437
38	5	072110438
39	6	072110439
40	6,5	072110440
41	7	072110441
42	8	072110442
43	9	072110443
44	10	072110444
45	10,5	072110445
46	11	072110446
47	12	072110447
48	13	072110448



~~€ 68,00~~ € 38,80



EN ISO 20345 2011 S1P SRC

Monza

Scarpe in pelle scamosciata con inserti in nylon mesh e PU

- Puntale in fibra di vetro
- Lamina antiperforazione in fibra composita

7313G (CE)

EU	UK	Articolo
35	2,5	073130635
36	3,5	073130636
37	4,5	073130637
38	5	073130638
39	6	073130639
40	6,5	073130640
41	7	073130641
42	8	073130642
43	9	073130643
44	10	073130644
45	10,5	073130645
46	11	073130646
47	12	073130647
48	13	073130648



~~€ 78,50~~ € 45,00

7313B (CE)

EU	UK	Articolo
35	2,5	073130835
36	3,5	073130836
37	4,5	073130837
38	5	073130838
39	6	073130839
40	6,5	073130840
41	7	073130841
42	8	073130842
43	9	073130843
44	10	073130844
45	10,5	073130845
46	11	073130846
47	12	073130847
48	13	073130848



~~€ 78,50~~ € 45,00



EN ISO 20345 2011 S1P SRC

**NUOVA LINEA
"ACTIVE"**



Novità

7314AF

Scarpe in pelle scamosciata con inserti in nylon mesh e carbon

- Puntale in composito
- Lamina antiperforazione in fibra composita

EU	UK	
35	2,5	073140235
36	3,5	073140236
37	4,5	073140237
38	5	073140238
39	6	073140239
40	6,5	073140240
41	7	073140241
42	8	073140242
43	9	073140243
44	10	073140244
45	10,5	073140245
46	11	073140246
47	12	073140247
48	13	073140248



EN ISO 20345 2011

S1P SRC

~~€ 80,50~~ € 45,90

7314AB

Scarpe in pelle scamosciata con inserti in nylon mesh e carbon

- Puntale in composito
- Lamina antiperforazione in fibra composita

EU	UK	
35	2,5	073140335
36	3,5	073140336
37	4,5	073140337
38	5	073140338
39	6	073140339
40	6,5	073140340
41	7	073140341
42	8	073140342
43	9	073140343
44	10	073140344
45	10,5	073140345
46	11	073140346
47	12	073140347
48	13	073140348



EN ISO 20345 2011

S1P SRC

~~€ 80,50~~ € 45,90

7315AN

Scarpe in pelle scamosciata e microfibra idrorepellenti con inserti in carbon

- Puntale in composito
- Lamina antiperforazione in fibra composita

EU	UK	
35	2,5	073150535
36	3,5	073150536
37	4,5	073150537
38	5	073150538
39	6	073150539
40	6,5	073150540
41	7	073150541
42	8	073150542
43	9	073150543
44	10	073150544
45	10,5	073150545
46	11	073150546
47	12	073150547
48	13	073150548



EN ISO 20345 2011

S3 SRC

~~€ 93,50~~ € 53,00

7318AN

Scarpe alte in pelle scamosciata e microfibra idrorepellenti con inserti in carbon

- Puntale in composito
- Lamina antiperforazione in fibra composita

EU	UK	
35	2,5	073180535
36	3,5	073180536
37	4,5	073180537
38	5	073180538
39	6	073180539
40	6,5	073180540
41	7	073180541
42	8	073180542
43	9	073180543
44	10	073180544
45	10,5	073180545
46	11	073180546
47	12	073180547
48	13	073180548



EN ISO 20345 2011

S3 SRC

~~€ 96,00~~ € 55,00

470 g

Scarpe in tessuto mesh ad alta traspirazione con inserti in PU Alta Frequenza e rinforzo protettivo del puntale in crosta scamosciata

- Puntale in alluminio
- Lamina antiperforazione in fibra composita
- Sistema di chiusura FixLock, semplifica la calzata e lo sfilamento della scarpa (in dotazione anche stringhe tradizionali)



7340B (CE)

FIT PRO NET



EU	UK	
36	3,5	073400236
37	4,5	073400237
38	5	073400238
39	6	073400239
40	6,5	073400240
41	7	073400241
42	8	073400242
43	9	073400243
44	10	073400244
45	10,5	073400245
46	11	073400246
47	12	073400247



EN ISO 20345 2011

S1P SRC

€ 130,00 € 74,00

7340Y (CE)

FIT PRO NET



EU	UK	
36	3,5	073400336
37	4,5	073400337
38	5	073400338
39	6	073400339
40	6,5	073400340
41	7	073400341
42	8	073400342
43	9	073400343
44	10	073400344
45	10,5	073400345
46	11	073400346
47	12	073400347



EN ISO 20345 2011

S1P SRC

€ 130,00 € 74,00

7340R (CE)

FIT PRO NET



EU	UK	
36	3,5	073400436
37	4,5	073400437
38	5	073400438
39	6	073400439
40	6,5	073400440
41	7	073400441
42	8	073400442
43	9	073400443
44	10	073400444
45	10,5	073400445
46	11	073400446
47	12	073400447



EN ISO 20345 2011

S1P SRC

€ 130,00 € 74,00

7341N (CE)

FIT PRO

Tomaia in microfibra idrorepellente



EU	UK	
36	3,5	073410236
37	4,5	073410237
38	5	073410238
39	6	073410239
40	6,5	073410240
41	7	073410241
42	8	073410242
43	9	073410243
44	10	073410244
45	10,5	073410245
46	11	073410246
47	12	073410247



EN ISO 20345 2011

S3 SRC

€ 137,00 € 77,00

Novità

- Resistenti • Traspiranti
- Rinforzi in nylon e cotone su pianta e tallone
- Prodotte con fibra naturale di bamboo
 - Antimicrobica ed antibatterica
 - Antiodore
- Assorbe l'umidità ed il sudore
- Tessuto più resistente rispetto al cotone
- Mantiene la temperatura corporea ad un giusto livello
- Leggerezza a traspirabilità

Nuova linea di CALZE da lavoro

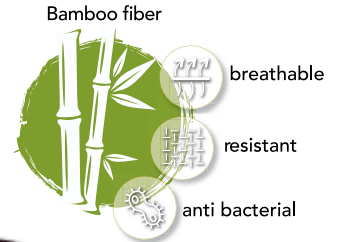

7421



M 39-42	074210002
L 43-46	074210004

~~€ 13,50~~ € 7,80

7423

M 39-42	074230002
L 43-46	074230004



~~€ 8,50~~ € 4,90

7425

M 39-42	074250002
L 43-46	074250004



~~€ 9,00~~ € 5,20

7427



M 39-42	074270002
L 43-46	074270004

~~€ 7,50~~ € 4,30

7429



M 39-42	074290002
L 43-46	074290004

~~€ 7,00~~ € 4,00

7398U

Sottopiedi anatomici
TPR GEL con elevato effetto ammortizzante, supporto dell'arco plantare e cuscinetto nella zona del tallone



36-40	073980058
41-46	073980063

~~€ 10,70~~ € 6,50

7840BL

Pantaloni da lavoro

- T/C Twill, 65% poliestere, 35% cotone, 245 g
- Fascia porta martello
- Triple cuciture nei punti di maggiore usura
- Chiusura metal zip
- Tasca porta metro con inserti porta penne o piccoli utensili



XS	078400100
S	078400101
M	078400102
L	078400103
XL	078400104
XXL	078400105
XXXL	078400106
XXXXL	078400107

~~€ 32,00~~ € 18,20

7860E

Pantaloni leggeri da lavoro

- T/C twill, 65% poliestere, 35% cotone, 180 g
- Fascia porta martello
- Triple cuciture nei punti di maggiore usura
- Chiusura metal zip
- Tasca porta metro con inserti porta penne o piccoli utensili
- Inserti per ginocchiere



XS	078600900
S	078600901
M	078600902
L	078600903
XL	078600904
XXL	078600905
XXXL	078600906
XXXXL	078600907

~~€ 44,50~~ € 25,70

7870E

Pantaloni leggeri da lavoro

- T/C twill, 65% poliestere, 35% cotone, 180 g
- Fascia porta martello
- Triple cuciture nei punti di maggiore usura
- Chiusura metal zip
- Tasca porta metro con inserti porta penne o piccoli utensili
- Inserti per ginocchiere



XS	078700900
S	078700901
M	078700902
L	078700903
XL	078700904
XXL	078700905
XXXL	078700906
XXXXL	078700907

~~€ 44,50~~ € 25,70

7830ST

Pantaloni da lavoro elasticizzati

- T/C Twill 250 g, grigio
- Cavallo antistrappo
- Vita elasticizzata ai lati
- Tasca porta metro e porta martello



XS	078300000
S	078300001
M	078300002
L	078300003
XL	078300004
XXL	078300005
XXXL	078300006



SLIM FIT



~~€ 50,50~~ € 28,80

7816BL

Pantaloni da lavoro multitasche blu

- T/C Canvas, 65% poliestere, 35% cotone, 260 g



XS	078160100
S	078160101
M	078160102
L	078160103
XL	078160104
XXL	078160105
XXXL	078160106

7816G

Pantaloni da lavoro multitasche

- T/C Canvas, 65% poliestere, 35% cotone, 260 g



XS	078160000
S	078160001
M	078160002
L	078160003
XL	078160004
XXL	078160005
XXXL	078160006

- Tasche per ginocchiere e fondo gamba inforzati in poliestere 600D
- Vita più alta nella parte posteriore per maggiore protezione della schiena
- Inserto posteriore elasticizzato per facilitare i movimenti
- Vita elasticizzata ai lati
- Anello per portachiavi in vita
- Ampie tasche laterali con chiusura a bottoni automatici, una dotata di inserto portabadge
- Cavallo antistrappo

~~€ 62,00~~ € 35,50

~~€ 62,00~~ € 35,50

7880SC

Pantaloni da lavoro elasticizzati Slim fit

- T/C Canvas, 63% poliestere, 34% cotone, 3% tessuto elasticizzato, 290 g
- Cavallo antistrappo
- Tasca porta metro e fascia porta martello
- Inserti porta ginocchiere

SLIM FIT



XS	078800000
S	078800001
M	078800002
L	078800003
XL	078800004
XXL	078800005
XXXL	078800006

- Tasca laterale sinistro con chiusura a strappo ed inserto porta badge
- Due ampie tasche anteriori
- Vita elasticizzata ai lati
- Due tasche posteriori con chiusura a strappo

~~€ 54,50~~ € 29,30

7900E

Pantaloni da lavoro multitasche

- In T/C Canvas, 65% poliestere, 35% cotone, 260 g
- Fascia porta martello
- Triple cuciture nei punti di maggiore usura
- Chiusura metal zip
- Tasca porta metro con inserti porta penne o piccoli utensili



XS	079000900
S	079000901
M	079000902
L	079000903
XL	079000904
XXL	079000905
XXXL	079000906
XXXXL	079000907

~~€ 48,00~~ € 27,30

7525

XS	075250046
S	075250048
M	075250050
L	075250052
XL	075250054
XXL	075250056
XXXL	075250058



7526

SLIM FIT

XS	075260046
S	075260048
M	075260050
L	075260052
XL	075260054
XXL	075260056
XXXL	075260058



Jeans da lavoro elasticizzati

- 68% Cotone denim, 29% poliestere, 3% tessuto elasticizzato, 100Z
- Rinforzi in poliestere 600D all'interno delle tasche posteriori e sul fondo gamba
- Tasca porta metro e fascia porta martello
- Cavallo antistrappo

YKK

Little Paris. Big Difference.

~~€ 52,00~~
€ 29,50

~~€ 60,00~~
€ 34,50

7811

Novità

Pantaloni "work trekking"

- 90% nylon, 10% tessuto elasticizzato, 230 g. grigio
- Vita elasticizzata
- Tessuto bi-estensibile per aumentare il comfort
- Fondo gamba elasticizzato con chiusura zip verticale

SLIM FIT

S	078110001
M	078110002
L	078110003
XL	078110004
XXL	078110005



~~€ 66,00~~ **€ 37,90**

7780T

Novità

Bomber da lavoro multitasche

- Tessuto principale: 100% nylon 300D, impermeabilizzato e resistente
- Inserti per favorire i movimenti: 95% poliestere 5% tessuto elasticizzato, impermeabilizzato
- Fodera: 100% poliestere
- Imbottitura in poliestere 160 g
- Cappuccio staccabile

S	077800101
M	077800102
L	077800103
XL	077800104
XXL	077800105
XXXL	077800106



~~€ 89,00~~ **€ 51,00**

7984G

Cintura da lavoro

- 100% TPE e fibbia in metallo zinco cromato
- taglia unica
- 125 cm accorciabile, larghezza 35 mm, nero



TAGLIA UNICA

079840525

~~€ 13,00~~ **€ 7,50**

7683

Giacca softshell con cappuccio e maniche staccabili

- 94% poliestere, 6% spandex, 290 g con cappuccio e maniche staccabili, Tessuto idrorepellente a tre strati, dotato di membrana TPU impermeabile, antivento e traspirante

S	076830001
M	076830002
L	076830003
XL	076830004
XXL	076830005
XXXL	076830006



~~€ 118,00~~ **€ 69,00**

7865E

Tuta leggera da lavoro

- T/C twill, 65% poliestere, 35% cotone, 180 g



XS	078650900
S	078650901
M	078650902
L	078650903
XL	078650904
XXL	078650905
XXXL	078650906
XXXXL	078650907

~~€ 69,50~~ € 39,80

7875E

Tuta leggera da lavoro

- T/C twill, 65% poliestere, 35% cotone, 180 g



XS	078750900
S	078750901
M	078750902
L	078750903
XL	078750904
XXL	078750905
XXXL	078750906
XXXXL	078750907

~~€ 69,50~~ € 39,80

7905E

Tuta da lavoro

- In T/C Canvas, 65% poliestere, 35% cotone, 260 g



XS	079050900
S	079050901
M	079050902
L	079050903
XL	079050904
XXL	079050905
XXXL	079050906
XXXXL	079050907



~~€ 75,50~~ € 43,30

7835ST

Tuta da lavoro elasticizzata

- T/C Twill 250 g, grigio



XS	078350000
S	078350001
M	078350002
L	078350003
XL	078350004
XXL	078350005
XXXL	078350006

~~€ 81,00~~ € 46,20

7869E

Giacca leggera da lavoro

- T/C twill, 65% poliestere, 35% cotone, 180 g



XS	078690900
S	078690901
M	078690902
L	078690903
XL	078690904
XXL	078690905
XXXL	078690906
XXXXL	078690907

~~€ 48,00~~ € 27,30

7909E

Giacca da lavoro

- In T/C Canvas, 65% poliestere, 35% cotone, 260 g



XS	079090900
S	079090901
M	079090902
L	079090903
XL	079090904
XXL	079090905
XXXL	079090906
XXXXL	079090907

~~€ 53,50~~ € 30,50

7863E

Salopette leggera da lavoro

- T/C twill, 65% poliestere, 35% cotone, 180 g

XS	078630900
S	078630901
M	078630902
L	078630903
XL	078630904
XXL	078630905
XXXL	078630906
XXXXL	078630907



~~€ 54,00~~ € 30,90

7873E

Salopette leggera da lavoro

- T/C twill, 65% poliestere, 35% cotone, 180 g

XS	078730900
S	078730901
M	078730902
L	078730903
XL	078730904
XXL	078730905
XXXL	078730906
XXXXL	078730907



~~€ 54,00~~ € 30,90

7903E

Salopette da lavoro

- In T/C Canvas, 65% poliestere, 35% cotone, 260 g

XS	079030900
S	079030901
M	079030902
L	079030903
XL	079030904
XXL	079030905
XXXL	079030906
XXXXL	079030907



~~€ 60,00~~ € 34,30

7833ST

Salopette da lavoro elasticizzata

- T/C Twill 250 g, grigio

XS	078330000
S	078330001
M	078330002
L	078330003
XL	078330004
XXL	078330005
XXXL	078330006



~~€ 60,50~~ € 35,00

7867E

Gilet multitasche leggero da lavoro

- T/C twill, 65% poliestere, 35% cotone, 180 g

XS	078670900
S	078670901
M	078670902
L	078670903
XL	078670904
XXL	078670905
XXXL	078670906
XXXXL	078670907



~~€ 41,00~~ € 23,30

7907E

Gilet multitasche da lavoro

- In T/C Canvas, 65% poliestere, 35% cotone, 260 g

XS	079070900
S	079070901
M	079070902
L	079070903
XL	079070904
XXL	079070905
XXXL	079070906
XXXXL	079070907



~~€ 45,00~~ € 25,80

www.beta-tools.com



Cal Crutchlow
MotoGP World Championship



50
years in
Motorsports



Beta

The Beta logo consists of a stylized orange icon resembling a 'B' or a tool head, followed by the word "Beta" in a bold, orange, sans-serif font.

Beta Utensili S.p.A.
Via Volta 18
20845 Sovico (MB)
Tel. 039.2077.1
Fax 039.2010742
www.beta-tools.it

Promozione valida dal 14/01/2019 al 16/12/2019.
Prezzi netti I.V.A. esclusa

Le immagini sono indicative, Beta si riserva il diritto di apportare aggiornamenti e migliorie alla propria gamma produttiva senza alcun preavviso.