



Beta

Action

**Promozione valida
dal 15/01/2018
al 14/12/2018
Prezzi netti I.V.A. esclusa**

Arredo officina



360°
view

 **Beta**
RSC 55

*Configura on-line
la tua officina*

www.beta-tools.it/RSC55



www.youtube.com/

www.betatools.com

32AU	34
38/B6	34
42...	20
42INOX/SC9	21
55/SP7	20
88/S7	21
90/S7	21
96/SC9	24
96BPC/SC9	24
96BP-CO/SC9	24
96LBP/SC9	24
96T/S5P	23
97BTX/SC8	24
97BTXL/SC8	24
97TTX/D6	23
142...	20
192/S2	21
195/B5	21
111	22
186 8-32	41
334	40
342	41
345C	41
351C	40
360	40
378	40
388C/C8	41
412/SP19P	35
415CO/SP19A	35
425 E/SP3	35
437U/09	35
446/C110	35
561/1	31
599DGT-A	31
605E	30
606	30
666N	30
677	31
720LC/C3	68
720S/SB6	78
852 1/4	23
860/C27	25
862F/A7	25
867/C20	25
867/C38	25
900/55	27
900/58	27
900/C12M	28
900/C12MR	28
900/C39	28
900/C39-R	28
902A/C22	28
910/55	27
910/58	27
910A/C16	29
910A/C16HR	29
920/55	27
920/55L	27
920/58	27
920A/C17M	29
920A/C17MR	29
928/55	27
928A/C12	29
933...	22
944BX/D6	22
951/S6	23
952/D7	22
960AD/TP2	56
960EPC	59

960KC-M8/9/10	59
960KPC	59
960PI/S	61
960RPI	60
960UC	60
961D...	52
984	67
1009L/DP-S2	32
1031/S4	33
1047 240	33
1048 250	33
1052	33
1128BAX	36
1149F	42
1169BM/D3	32
1169MQ/D2	32
1203/D10N	26
1203/D8P	26
1207TX/D7	26
1256/C36-2	42
1263/D10	26
1263/D8	26
1267TX/D7	26
1273MQ/D6	26
1293/D8	26
1293INOX/D8	26
1344	72
1360/K6	71
1362	72
1365/K13	70
1366/K5	70
1366A	71
1366/KF	71
1367/S6	72
1368	70
1368G/K400	70
1370	34
1380	34
1390	34
1428/SB11	38
1430/S8	37
1438DSG	64
1457/B4	69
1462/KI	60
1462CF/C6	61
1464AP	56
1464APB	56
1464IC	57
1464PF	57
1464PT	57
1464T	56
1464TDI	56
1466/C5	65
1471M/C22	66
1472FCA	58
1472H	58
1478/3P	71
1479L/S2	71
1482	64
1485BP	62
1485MJ	62
1485VAG/K2	62
1493B/S5	64
1493DSG	63
1493FT	64
1497CEL	58
1498/2A	52
1498/40A	53
1498/4A	52

1498/8A	52
1498/24	55
1498C/24	55
1498CM/12	54
1498LT/12	54
1498MN/12	54
1498PC	72
1498TB/12	53
1498TC	53
1500	38
1511	38
1529/C7	62
1530/C5	67
1535C	39
1545/C5M	39
1547/C6	39
1548/C8	63
1550U...	69
1558/C4	67
1567	68
1569/A	66
1569/B	66
1569CP/...	67
1606A/C9	42
1609B	42
1651DGT...	37
1691BM	37
1726	36
1740B 330	43
1741B	43
1741U	43
1749AC	44
1750 500	44
1750TA	44
1756C	44
1756D	44
1758LG	65
1759HD/3	58
1760/RMS	43
1760PA/AC-DC	53
1767A	68
1771	36
1778V18	36
1834P...	47
1836A	47
1837N	47
1838/11LED	49
1838COB	48
1838FLASH	48
1838SLR	48
1842LED/ABM	49
1846LED/BM	49
1848	49
1852R1750	46
1860...A	46
1870	45
1871M	45
1872L 35	45
1877	65
1877A	65
1884	63
1895 6	61
1901BM/8	83
1901T/10	83
1921I	81
1927CD/K3	78
1927P	78
1927XM/K5	78
1928CD	79

1928DA	79
1928K4	79
1930HLA	80
1930PA	80
1930ZL	80
1933I	82
1937	81
1937KC	81
1937RT	81
1940E10	82
1942A	82
1946C 4,8	83
1947G	83
1949GPE	82
1972/12	50
1972/18	51
1982/12EF	50
1984/18QM	51
2037/TV	13
2038/TV	13
2080/V12	11
2250-O	73
2254T	74
3002	73
3003	73
3007	74
3009	74
3025...	77
3026...	77
3027...	76
3030/2T	75
3035	68
3065/40 20T	75
3067/70 13T	75
3500/P	8
5904U/MP	3
5904VA/T	4
5914VU/M	12
5927VU/M	9
5935V1/2MB	8
5988U6/MP	2
5988UX/MP	5
7042LCD	46
7200PN	87
7201PN	87
7210PB	87
7211PG	87
7212FG	86
7213FG	86
7214FN	86
7215FN	86
7236B	85
7237WR	85
7238WR	85
7241C	84
7243C	84
7245B	84
7246B	84
7249G	85
7290NA	91
7291NA	91
7293NKK	91
7294NKK	91
7313B	88
7313G	88
7316N	88
7323M	88
7340B	90
7340R	90

7340Y	90
7341N	90
7360UN	89
7361UB	89
7368UN	89
7369UB	89
7816BL	92
7816G	92
7830ST	93
7831ST	93
7833ST	93
7835ST	93
7840BL	92
7860E	95
7861E	95
7863E	95
7865E	95
7867E	95
7869E	95
7870E	96
7871E	96
7873E	96
7875E	96
7877E	96
7879E	96
7880SC	92
7900E	94
7901E	94
7903E	94
7905E	94
7907E	94
7909E	94
8889I /7,5	8
C04TSS/7	9
C5	14
C6T	14
C7	14
C8	15
C9	14
C10	15
C10S	15
C11	14
C12	15
C14	12
C20L	11
C24S...	4
C24SAXL...	5
C24SL-CAB	6
C27S	9
C28	6
C33...	3
C35...	8
C39...	2
C41H...	10
C42H	10
C51	7
C56	7
C59A	7
CP15...	11
CP17	11
CP51	7
CX49 G	55
M10-M100	16
M120-M288	17
T10-T92	18
T103-T239	19

C39 Aluminium AL

Cassettiera mobile

- Quattro ruote con nucleo in acciaio Ø 125 mm: 2 fisse e 2 girevoli (una con freno).
- Serratura di sicurezza centralizzata frontale.

Struttura portante in lega di alluminio
+ RESISTENZA + LEGGEREZZA



Cassetto ad estrazione totale con sistema di apertura posizionato su tutta la lunghezza del cassetto.

Piano di lavoro multifunzione ad alta resistenza con portaminuterie e fori per l'alloggiamento dei giravite



Portacarta e portaflaconi laterali e posteriori



971 mm
500 mm
800 mm



	Ral 2011	Ral 7016	Ral 3000	n° 367mm 588mm	n° h max ↓ max	kg	€
C39/6	039000031	039000032	039000033	6	4 70 mm 30 kg 1 140 mm 35 kg 1 210 mm 35 kg	59	€ 1.225,00 € 680,00
C39/7	039000001	039000002	039000003	7	5 70 mm 30 kg 1 140 mm 35 kg 1 210 mm 35 kg	61	€ 1.295,00 € 720,00
C39/8	039000041	039000042	039000043	8	6 70 mm 30 kg 2 140 mm 35 kg	64	€ 1.380,00 € 765,00

SOFT
MODULE
SYSTEM



5988 U6/MP

Assortimento di 214 utensili in termoformato morbido

consigliato in abbinamento con le cassettiere: C24S-C24SL-C33-C39 C28-C59

L 059880530 XL 059880531

~~€ 2.440,00~~ € 1.400,00

solo assortimento

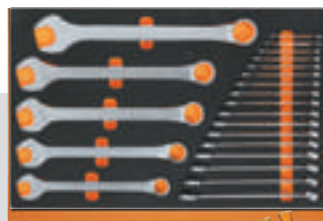

M10

22



M30

31

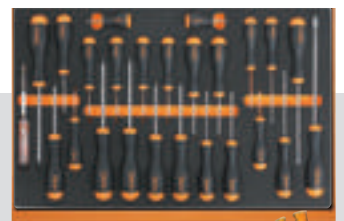

M210

25



M230

25

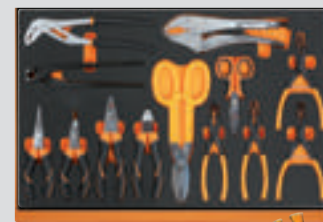

M130

13

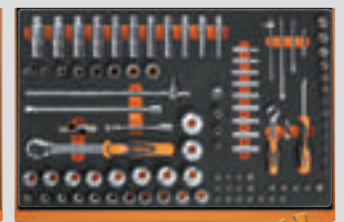

M100

98

Novità

C33

Più alta, più robusta, più sicura!

Cassettiera mobile

con cassetti da 588x367 mm montati su guide telescopiche a sfera

- Quattro ruote con nucleo in acciaio Ø 125 mm: 2 fisse e 2 girevoli (una con freno).
- Serratura di sicurezza centralizzata frontale.



Pratica scanalatura a "V" per la lavorazione di tubi o profilati.

Portaflaconi e portacarta laterali integrati regolabili in più posizioni.

Paracolpi angolari su tutta l'altezza della cassettiera per evitare, in caso di urto, il danneggiamento dei veicoli all'interno dell'officina.

Piano di lavoro multifunzione ad alta resistenza con portaminuterie e fori per l'alloggiamento dei giravite



Cassetto ad estrazione totale con sistema a sgancio rapido in nylon rinforzato con fibra di vetro e possibilità di apertura su tutta la lunghezza del cassetto.



1020 mm
500 mm
810 mm

	Ral 2011	Ral 7016	Ral 3000	n° 367mm 588mm	n° h ↓ max	kg	€
C33/6	033000261	033000262	033000263	6	4 75 mm 30 kg 1 150 mm 35 kg 1 305 mm 35 kg	69	€ 830,00 € 480,00
C33/7	033000271	033000272	033000273	7	5 75 mm 30 kg 1 150 mm 35 kg 1 225 mm 35 kg	71	€ 890,00 € 515,00
C33/8	033000281	033000282	033000283	8	6 75 mm 30 kg 2 150 mm 35 kg	73	€ 950,00 € 550,00



5904U/MP

Assortimento di 91 utensili, in termoformato morbido

consigliato in abbinamento con le cassette: C24S-C24SL-C33-C39 C28-C59



M15 M33 M199 M202



M50 M83



M132 M153 M234 M145

SOFT
MODULE
SYSTEM

L 059040428 XL 059040429

€ 1.037,00 € 598,00

solo assortimento

C24S

Cassettiera mobile

- Quattro ruote con nucleo in acciaio Ø 125 mm: 2 fisse e 2 girevoli (una con freno).
- Serratura di sicurezza centralizzata
- Possibilità di applicazione del portacarta 2400S-R/PC (da ordinare separatamente)



Piano di lavoro in ABS ad alta resistenza



Portaflaconi laterale integrato



Cassetto ad estrazione totale con sistema di apertura in nylon rinforzato in fibra di vetro posizionato su tutta la lunghezza del cassetto.

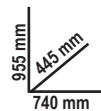

	Ral 2011	Ral 7016	Ral 3000	n° 367mm 588mm	n° h max	kg	€
C24S/6	024002061	024002062	024002063	6	4 70 mm 25 kg	55	€ 698,00 € 395,00
					1 140 mm 30 kg		
					1 280 mm 35 kg		
C24S/7	024002071	024002072	024002073	7	5 70 mm 25 kg	58	€ 755,00 € 428,00
					1 140 mm 30 kg		
					1 210 mm 30 kg		
C24S/8	024002081	024002082	024002083	8	6 70 mm 25 kg	61	€ 815,00 € 465,00
					2 140 mm 30 kg		



5904VA/T

Assortimento di 102 utensili in termoformato rigido

consigliato in abbinamento con le cassettiere: C24S-C24SL-C33-C39 C28-C59



T199 T202 T83



T145 T153 T131 T234



T52 T33 T15 T16



T63 VP5

L 059040410 XL 059040411

~~€ 1.355,00~~ **€ 780,00**

solo assortimento

C24SA-XL/7

Cassettiera mobile con sistema antiribaltamento, modello lungo

- Quattro ruote con nucleo in acciaio Ø 125 mm: 2 fisse e 2 girevoli (una con freno).
- Serratura di sicurezza centralizzata frontale.
- Possibilità di applicazione del portacarta 2400S-R/PC (da ordinare separatamente)

Piano di lavoro in ABS, con 6 vaschette portaminuterie.



Cassetto ad estrazione totale con sistema di apertura in nylon rinforzato in fibra di vetro posizionato su tutta la lunghezza del cassetto con porta-etichette integrato.

Portafiletti laterale integrato.

Sistema antiribaltamento

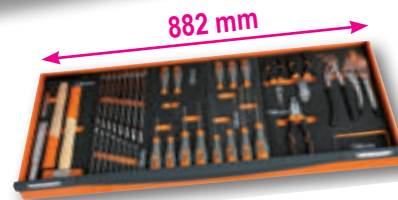

970 mm
445 mm
1035 mm

può contenere 6 termoformati

	Ral 2011	Ral 7016	Ral 3000	n° 367mm 568mm	n° h ↓ max	kg	€
C24SA-XL/7	024002271	024002272	024002273	7	5 70 mm 30 kg 1 140 mm 35 kg 1 210 mm 35 kg	84	€ 995,00 € 565,00
C24SA-XL/8	024002281	024002282	024002283	8	6 70 mm 30 kg 2 140 mm 35 kg	88	€ 1.070,00 € 610,00
C24SA-XL/9	024002331	024002332	024002333	9	8 70 mm 30 kg 1 140 mm 35 kg	92	€ 1.130,00 € 650,00

SOFT MODULE SYSTEM



5988UX/MP

Assortimento di 135 utensili in termoformato morbido per cassettera C24SA-XL



M16 M15 M33 M145 M131 M50 M55 M153 M199 M202



M234 M236 M83 M289 M91

L 059880540 XL 059880541

€ 1.545,00 € 890,00

solo assortimento



C24SL-CAB

Cassettiera mobile con 7 cassetti e armadietto porta-oggetti

- Quattro ruote con nucleo in acciaio Ø 125 mm: 2 fisse e 2 girevoli (una con freno).
- Serratura centralizzata frontale.
- Portacarta integrato.



Armadietto laterale portaoggetti con ripiano interno regolabile in altezza e anta richiudibile con serratura

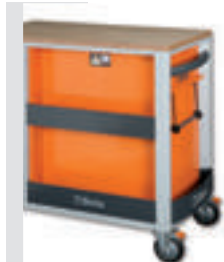

Doppio portaflaconi posteriore.



024002191 024002192 024002193

€ 1.150,00 € 660,00

Piano di lavoro in legno multistrato con fori per la collocazione di una morsa 1599F/100 (da ordinare separatamente).

kg
1100



n°	n° 367mm 588mm	↓ max
5	70 mm	25 kg
1	140 mm	30 kg
1	210 mm	30 kg

80 kg
970 mm
565 mm
1050 mm



C28

Carrello SuperTank con piano di lavoro e dieci cassetti

- Cinque cassetti laterali e cinque cassetti frontali
- Quattro ruote con nucleo in acciaio Ø 125 mm: 2 fisse e 2 girevoli con freno).
- 2 serrature di sicurezza centralizzate.
- 4 portaflaconi: 2 frontali e 2 posteriori.
- 6 vaschette portaminuterie laterali.
- Vano passante altezza 135 mm con base ricoperta in materiale plastico.



Sistema rapido e sicuro per l'apertura e chiusura dei cassetti con frontalino in nylon e fibra di vetro.



Vano laterale con antina di chiusura a scomparsa con serratura.

945 mm
800 mm
1235 mm
130 kg

n°	n° 367mm 588mm	↓ max
8	70 mm	25 kg
2	210 mm	30 kg

Piano di lavoro in legno multistrato con fori per la collocazione di una morsa (1599F/150 da ordinare separatamente).

kg
1200



028000301 028000302 028000303

€ 1.990,00 € 1.145,00



C59A

Banco con 1 cassetiera da 6 cassetti

- Frontalino dei cassetti in Nylon e fibra di vetro.
- Cassettiere predisposte per l'inserimento di termoformati.
- Serratura di sicurezza centralizzata frontale.
- Ripiano inferiore portaoggetti.
- predisposizione per portacarta (2400S-R/PC) e portafilaconi (2400S/PF) da ordinare separatamente.



059000001 059000021 059000041

€ 1.275,00 € 725,00

Ripiano in legno multistrato con fori per la collocazione di una morsa 1599F/125 (da ordinare separatamente).

Kg
1500

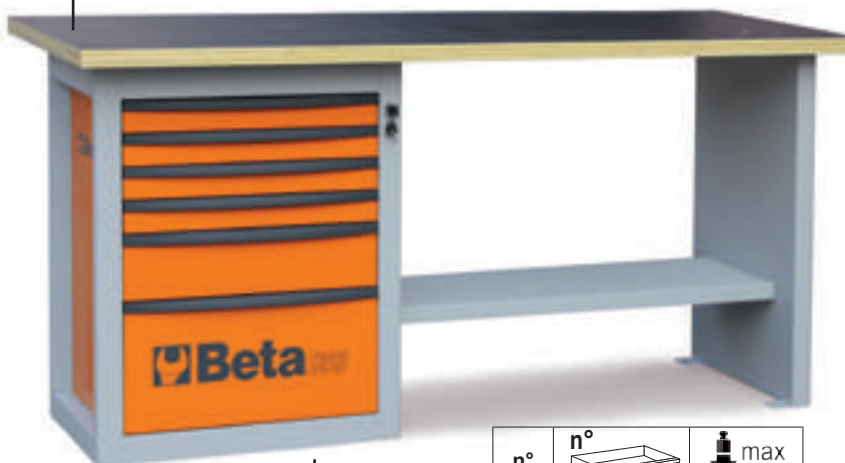

900 mm
700 mm
2000 mm

115 kg

n°	n° 367mm 588mm	↓ max
4	70 mm	25 kg
1	140 mm	30 kg
1	280 mm	35 kg



C56

Banco da lavoro

- Piano di lavoro in lamiera verniciata con bordo perimetrale
- Struttura in acciaio con 6 gambe di sostegno
- Due cassetti dotati di serratura
- Predisposizione per il fissaggio al pavimento



056000201 056000202 056000203

€ 720,00 € 410,00

Kg
1200



82 kg

930 mm
640 mm
2000 mm



C51

Carrello

- 3 ripiani ricoperti in gomma millerighe antiscivolo
- Doppia possibilità di fissaggio del ripiano centrale
- Quattro ruote Ø 100 mm:

2 fisse e 2 girevoli (una con freno)

Kg
200



21 kg

900 mm
450 mm
800 mm

051000001 051000002 051000003

€ 205,00 € 116,00



CP51

Carrello ad alta resistenza

- 2 ripiani ricoperti da tappetini in gomma
- Quattro ruote Ø 125 mm ad alta resistenza:

2 fisse e 2 girevoli con freno

Kg
750



37 kg

900 mm
600 mm
900 mm

051000501 051000502 051000503

€ 268,00 € 153,00

C35

Novità

Cassettiera fissa modello industriale

- Con cassetti ad estrazione totale
- Serratura di sicurezza centralizzata frontale

kg
1200



3500/P

Piano di lavoro con bordo perimetrale
717x600 mm



035000502

~~€ 76,00~~ € 44,00

8889C6/7,5

Separatori incrociati
per cassetto
altezza 7,5 cm

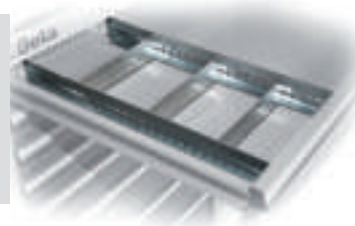

088890475

~~€ 24,00~~ € 14,00



	Ral 7000-7035	n° 447mm 600mm	n° h max 	kg	€
C35/6	035000062	6	2 75 mm 70 kg 1 100 mm 70 kg 1 150 mm 70 kg 1 200 mm 70 kg 1 300 mm 70 kg	73	€ 870,00 € 500,00
C35/7	035000072	7	2 75 mm 70 kg 1 100 mm 70 kg 3 150 mm 70 kg 1 200 mm 70 kg	77	€ 920,00 € 530,00
C35/8	035000082	8	4 75 mm 70 kg 1 100 mm 70 kg 2 150 mm 70 kg 1 200 mm 70 kg	80	€ 970,00 € 560,00
C35/9	035000092	9	6 75 mm 70 kg 3 150 mm 70 kg	84	€ 1.020,00 € 590,00



**SOFT
MODULE
SYSTEM**

Novità

5935VI/MB

Assortimento industria di 133 utensili per cassettera C35,
in termoformato morbido



MB11

30



MB34

52

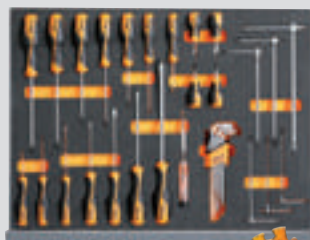

MB44

34



MB55

17

per cassetto: 600x447 mm

L 059350410 XL 059350411

~~€ 1.660,00~~ € 950,00



Beta INDY

Contenitori

Kg
700

C04TSS/7

Cassettiera mobile con 7 cassetti in acciaio inossidabile

- Quattro ruote con nucleo in acciaio inossidabile Ø 125 mm: 2 fisse e 2 girevoli con freno.
- Serratura frontale centralizzata;
- **Struttura interamente in acciaio inossidabile**
- **Ruote, supporti, sfere, interno dei cassetti e relative guide in acciaio inossidabile**
- Maniglia cassetti in alluminio

n°	h	max
6	83 mm	25 kg
1	170 mm	30 kg

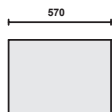

024003077

€ 2.020,00 € 1.160,00



63 kg



C27S

Carrello portautensili richiudibile per interventi esterni, vuoto

- Struttura in lamiera.
- Carrello richiudibile con colonnine ribaltabili per permettere un agevole trasporto.
- 2 cassetti 588x277 mm montati su guide telescopiche che permettono l'apertura in due sensi.
- Ampio vano portaoggetti inferiore 588x277x220 mm.
- 2 ruote fisse Ø 160 mm e 2 ruote piroettanti con freno Ø 100 mm
- Piano di lavoro termoplastico con 6 vaschette portaminuterie integrate.
- Chiusura centralizzata.
- Predisposizione per l'alloggiamento di separatori per cassetto e termoformati portautensili MC.



027000201

027000202

027000203

€ 525,00

€ 299,00

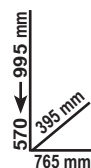

20 kg

n°	h	max
2	70 mm	20 kg



5927VU/M

Assortimento di 108 utensili in termoformato morbido per carrello C27S

059270021

€ 789,00

€ 455,00

solo assortimento



**SOFT
MODULE
SYSTEM**



MC10

per cassetto: 588x277 mm



MC20

C41H

Trolley portautensili con 3 cassetti

- Struttura in lamiera e in materiale plastico: grande robustezza e peso ridotto.
- 2 moduli separabili: 1 cestello superiore, 1 modulo con 2 cassetti altezza 95 mm, 1 cassetta estraibile in materiale plastico altezza 66 mm e 1 cassetto altezza 295 mm.
- Ruote di grosso diametro \varnothing 160 mm integrate nella struttura per facilitare il trasporto anche su gradini.
- Serratura centralizzata laterale per la chiusura dei cassetti del modulo inferiore.
- Cassetti montati su guide telescopiche a sfera con doppio gancio di chiusura.
- Impugnatura con manico telescopico in alluminio.
- Portaminuterie integrato
- Cassetto inferiore con doppia guida telescopica



C41H W
RAL 9016

C41H Y
RAL 1023

C41H R
RAL 3000

C41H V
RAL 6024

C41H B
RAL 5002

C41H G
RAL 7016

C41H N
RAL 9005

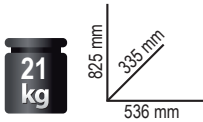

041000002	041000021	041000012	041000008
041000024	041000006	041000010	041000005
€ 445,00		€ 250,00	



C42H

Trolley portautensili a 3 moduli sovrapponibili

- Struttura in lamiera e materiale plastico
- 3 moduli separabili: 1 cestello superiore, altezza 220 mm 1 modulo portautensili centrale, altezza 180 mm 1 modulo portautensili inferiore con ruote, altezza 330 mm
- Possibilità di utilizzo con 2 soli moduli

Manico telescopico regolabile in 3 posizioni.



Ruote di grosso diametro (\varnothing 160 mm)

042000002

€ 320,00 **€ 179,00**



Cestello superiore con vano portaoggetti interno e 3 portaminuterie integrate nel coperchio



Sistema di sgancio rapido dei moduli: agevole e veloce accesso a tutti i diversi scomparti portautensili.

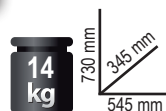

C20L

Cestello estendibile a 5 scomparti in lamiera, vuoto

021200002

~~€ 64,00~~

€ 36,50



550x200x210 mm

CP17

Cestello portautensili in acciaio inox e materiale plastico con contenitore asportabile, vuoto

021170500

~~€ 66,00~~

€ 38,00



500x200x220 mm

CP15L

Cestelli in materiale plastico, vuoti

- 3 vaschette portaminuterie integrate nel coperchio con divisori regolabili
- 1 contenitore interno con divisori regolabili
- Portata massima: 30 kg



558x277x270 mm

021150202

~~€ 48,00~~

€ 27,50



CP15



445x240x250 mm

021150201

~~€ 36,00~~

€ 20,50

2080/V12

Valigia organizer con 12 vaschette asportabili

020800000

~~€ 44,50~~

€ 25,50

300x330x145 mm



Vaschette portaminuterie asportabili, richiudibili e trasparenti per un' immediata riconoscibilità del contenuto.



C14

Trolley portautensili in polipropilene con 4 cassetti, vuoto

- Struttura in polipropilene a iniezione che garantisce elevata resistenza agli urti
- 4 robuste ruote posteriori
- 3 vaschette porta minuteria incluse
- Targhetta identificativa portanome
- Predisposizione per la chiusura con lucchetto TSA
- Ruote di grosso diametro (ø 160 mm)

Vassoio superiore removibile



La parte anteriore, protetta dal coperchio frontale, ospita 4 cassetti 470x255 mm estraibili:
 1 cassetto altezza 30 mm
 2 cassetti altezza 60 mm
 1 cassetto altezza 90 mm



La serratura centralizzata frontale consente di chiudere contemporaneamente i due coperchi, quello superiore e quello frontale

Due maniglie laterali



10 kg

021140000

€ 640,00 € 370,00

580x380x455 mm

Novità

5914VU/M

Assortimento di 109 utensili per trolley C14, in termoformato morbido



MC T1

70



MC T2

29



MC T3

10

* per l'utilizzo in abbinamento con il trolley C14, occorre rimuovere il pannello portautensili superiore

059140109

€ 864,00 € 499,00

* solo assortimento

Novità

2037/TV

Trolley portautensili in polipropilene con 4 ruote pivotanti, vuoto

- Estremamente resistente agli urti. Indicato per il trasporto di utensili in aereo
- 2 vaschette portaminuterie incluse
- Maniglia ergonomica rivestita in gomma
- Tasca porta documenti

2 pannelli portautensili removibili.



7 kg

020370000

€ 495,00 € 285,00



420x325x275 mm

Contenitori



4 ruote pivotanti removibili che consentono la movimentazione orizzontale del trolley



2 serrature omologate TSA con chiave

Novità

2038/TV

Trolley portautensili in polipropilene ad alto spessore, vuoto

- Estremamente resistente agli urti
- Profilo di tenuta in alluminio
- Maniglione telescopico e grandi ruote con cuscinetti a sfera
- Fondo capiente
- Tasca porta documenti
- 3 vaschette portaminuterie incluse

2 pannelli portautensili removibili.



9 kg

020380000

€ 655,00 € 380,00



430x500x340 mm

• 2 maniglie (1 laterale) ergonomiche rivestite in gomma



2 serrature omologate TSA con chiave

Borse portautensili

Leggere e altamente resistenti per trasportare



C5

Zaino

- Pannello portautensili interno removibile
- 6 tasche esterne e 2 tasche interne
- Base in materiale plastico resistente all'acqua
- Doppio laccetto di sicurezza per fissare lo zaino sulle spalle
- Schienale ergonomico imbottito

021050000

~~€ 118,00~~ € 67,50

500x400x180 mm



La borsa si apre anteriormente per facilitare l'accesso agli utensili sul luogo di lavoro



C6T

Zaino con ruote

- Manico telescopico di trasporto
- Ruote integrate nella struttura con copertura anti-polvere per l'impiego come zaino
- 2 pannelli portautensili removibili
- Tasca perota PC interna e 5 tasche esterne
- Base in materiale plastico resistente all'acqua

480x370x220 mm

021060010

~~€ 168,00~~ € 96,50



C11

Cestello

- Base rigida in materiale plastico resistente all'acqua
- Elastici e tasche portautensili sia interne che esterne
- Buste portadocumenti integrate nel doppiofondo del coperchio

021110000

~~€ 69,00~~ € 39,50

C7

Valigia

- 2 pannelli interni portautensili removibili
- 2 tasche esterne frontali
- Fondo interno in materiale plastico con divisori removibili



440x370x170 mm

021070000

~~€ 175,00~~ € 100,50



C9

Borsa

- Base rigida
- Tasche interne ed esterne per l'inserimento di utensili
- Doppio fondo
- Doppio laccio per livelli
- Tracolla per facilitare il trasporto

021090000

~~€ 93,00~~ € 53,50



550x200x210 mm

*in tessuto tecnico
in totale sicurezza e comodità i tuoi utensili*

Contenitori

C12

Borsa

- Pannello interno portautensili estraibile
- Elastici portautensili e capienti tasche sia interne che esterne
- Base rigida impermeabile con piedini in gomma



500x370x270 mm

021120000

~~€ 152,00~~ € 88,00

Cestello

- Struttura rigida
- Doppio fondo
- Manico inclinabile per facilitare l'accesso agli utensili
- Elastici portautensili e tasche sia interne che esterne
- Fodero di copertura
- Vaschetta portaminuterie inclusa nel doppio fondo
- Predisposizione per essere utilizzata con il trolley C8



(C10 - 520 mm) (C10S - 420 mm)

C10

021100000

~~€ 118,00~~ € 67,50 520x220x250 mm

C10S

021100001

~~€ 91,00~~ € 52,00 420x220x250 mm



400x240x220 mm



C10S

C8

C8

Trolley

- Manico telescopico di trasporto
- 2 pannelli interni portautensili removibili
- Tasca porta PC interna e 2 tasche esterne frontali
- Predisposizione per l'alloggiamento del cestello C10S



470x370x280 mm

021080000

~~€ 195,00~~ € 111,50



M10

024500010

€ 346,00 € 200,00

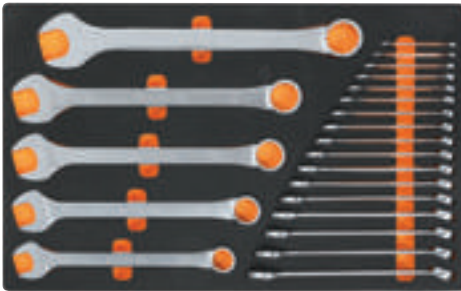

22

42 6-7-8-9-10-11-12-13-14-15-16-17-18-19-20-21-22-24-27-30-32-36 mm

M30

024500030

€ 317,00 € 183,00



31

55 6x7-8x9-10x11-12x13-14x15-16x17-18x19-20x22-21x23-24x27-30x32 mm
90 6x7-8x9-10x11-12x13-14x15-16x17-18x19-20x22-21x23-24x27-30x32 mm
96BPC/SC9 1,5-2-2,5-3-4-5-6-8-10 mm

M60

024500060

€ 297,00 € 172,00



24

○ 96T 2-2,5-3-4-5-6-7-8-10 mm
○ 97BTX/SC8 T9-T10-T15-T20-T25-T27-T30-T40
○ 944BX 5-6-7-8-10-13 mm

M63

024500063

€ 267,00 € 154,00



8

○ 952 7-8-10-12-13-14-17-19 mm

M65

024500065

€ 407,00 € 235,00

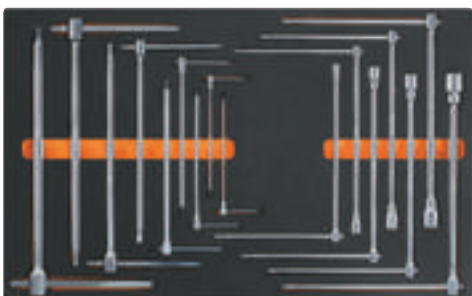

16

○ 950 8-10-12-13-14-17-19 mm
○ 951 2,5-3-4-5-6-8-10-12-14 mm

M100 12" 14"

024500100

€ 971,00 € 562,00



98

895/1 - 895/3 - 895/6
○ 900 4-4,5-5-5,5-6-7-8-9-10-11-12-13-14 mm
○ 900L 5-6-7-8-9-10-11-12-13 mm
○ 900ME 3-4-5-6-7 mm
● 900LP 0,8x4-1x5,5-1,2x6,5-1,2x8 mm
⊕ 900PH PH1-PH2-PH3-PH4
○ 900TX T10-T15-T20-T25-T27-T30-T40
900/20 50 mm - 900/20L 100 mm
900/21 150 mm
900/25 - 900BG/30 - 900/42
⊕ 900/55
○ 920A 8-10-11-12-13-14-15-16-17-18-19-20-21-22-23-24-26-27-28-30-32 mm
920/15 - 920/25
920AN/125 125 mm
920AN/250 250 mm
920/42
⊕ 920/55
○ 920FTX 10-12-14-16-18-20-22-24 mm
○ 920AL 10-12-13-14-15-16-17-18-19-21-22 mm

Termoformati morbidi

M121 12"

024500121

~~€ 957,00~~ € 554,00



46

- 920BP 5L-6L-8L-10L-5XL-6XL-8XL mm
- 920TX T20-T25-T27-T30-T40-T45L-T50L-T55L-T60L-T70L
- 920XZN 4-5-6-6L-8-8L-10-10L-12-12L-14-14L-16-18 mm
- 920ES 7-9-10-11-12L-14L-16L-7XL-9XL-10XL-11XL-12XL-14XL-16XL mm
- 920/36A

M120 12"

024500120

~~€ 1.041,00~~ € 600,00



75

- 920A 10-11-12-13-14-15-16-17-18-19-20-21-22-24-26-27-30-32 mm
- 920AN/125 125 mm
- 920AN/250 250 mm
- 920/25 - 920/42
- 920AL 10-12-13-14-15-16-17-18-19-22-24-27-30-32 mm
- 920FTX 10-12-14-16-18-20-22-24 mm
- 920/55
- 920PE 5-5L-6-6L-7-7L-8-8L-10-10L-12-12L-14-14L
- 920TX T20-T25-T27-T30-T40-T45-T50-T55-T60-T20L-T25L-T27L-T30L-T40L-T45L-T50L

M130

024500130

~~€ 331,00~~ € 191,00



13

- 1032 180 mm
- 1034 170 mm
- 1036 175 mm
- 1038 175 mm
- 1048 250 mm
- 1052 240 mm
- z 1082BM 160 mm
- 1098 220 mm
- 1112 250 mm
- 1128BM
- 1150BM 180 mm
- 1166BM 160 mm
- 1168BM 160 mm

M210

024500210

~~€ 162,50~~ € 94,00



25

- 1201 2,5x50-3x75-4x100-5,5x125-6,5x150-8x200 mm
- 1201N 4x30 mm
- 1202 PH0x60-PH1x80-PH2x100-PH3x150 mm
- 1202N PH1x30 mm
- 1207TX T6-T7-T8-T9-T10-T15-T20-T25-T27-T30-T40-T45
- 1253

M230

024500230

~~€ 311,00~~ € 180,00



25

- 30 Ø 2-3-4 mm
- 31 Ø 2-3-4-5-6-8 mm
- 32 Ø 4 mm
- 34 150 mm
- 35 200-250 mm
- 36 125 mm
- 1370 500 g
- 1390 Ø 35 mm
- 1692 3 m
- 1712
- 1719BMA/Q 200 mm
- ▲ 1719BMA/T 200 mm
- ▬ 1719BMA/P 200 mm
- ▷ 1719BMA/M 200 mm
- 1719BMA/R 200 mm
- 1737
- 1771 18 mm

M288

Novità

024500288

~~€ 191,00~~ € 110,00



9

- 1128BMX
- 1130BMX
- 1719BMA/Q 200 mm
- 1719BMA/P 200 mm
- ▷ 1719BMA/M 200 mm
- 1719BMA/R 200 mm
- 1726BM 400mm
- 1728BM (5)
- 1771BM 170 mm
- 1778V18 185 mm

T10 024240010
~~€ 211,50~~ € 122,00



42 6-7-8-10-11-12-13-14
 16-17-18-19-21-22-24-27-30 mm

T15 024240015
~~€ 161,50~~ € 93,00



42 6-7-8-9-10-11-12-13-14
 15-16-17-18-19-20-21 mm

T16 024240016
~~€ 114,50~~ € 66,00



42 22-24-27-30-32

T31 024240031
~~€ 172,00~~ € 99,00



31 Ø 2-3-4-5-6 mm
 32 Ø 4 mm
 55 6x7-8x9-10x11-12x13-14x15-16x17-18x19
 20x22-21x23-24x26-27x29-30x32 mm
 ○ 96N/SC9 1,5÷10 mm

T40 024240040
~~€ 81,00~~ € 47,00



90 6x7-8x9-10x11-12x13
 14x15-16x17-18x19 mm

T45 024240045
~~€ 243,50~~ € 140,00



142 8-9-10-11-12-13-14
 15-16-17-18-19 mm

T46 024240046
~~€ 288,00~~ € 167,00



142SN 8-9-10-11-12-13-14
 15-16-17-18-19 mm

T50 024240050
~~€ 136,00~~ € 78,00



○ 96T 2-2,5-3-3,5-4-4,5-5-6-7-8-10 mm

T55 024240055
~~€ 76,00~~ € 44,00



○ 97TTX T10-T15-T20 T25-
 T27-T30

T63 024240063
~~€ 260,00~~ € 150,00



○ 952 7-8-10-12-13-14-17-19 mm

T83 024240083
~~€ 269,00~~ € 155,00



12" ○ 920A 10-11-12
 13-14-15-16-17-18
 19-20-21-22-23-24
 26-27-30-32 mm
 920/21 125 mm
 920/22 255 mm
 920/25
 920/42 305 mm
 920/55 Ⓞ 275 mm

T85 024240085
~~€ 270,00~~ € 156,00



14" 81

- 861LP 0,5x3-0,6x4,5-0,8x5,5-1x5,5
 1,2x6,5-1,2x8-1,6x8 mm
- 861PE 2-2,5-3-4-5-6-8-10 mm
- ⊕ 861PH PH0- PH1 - PH2 - PH3
- ⊕ 861PZ PZ1 - PZ2 - PZ3
- ⊕ 861TX T6-T7-T8-T9-T10-T15-T20-T25
 T27-T30-T40
- ⊕ 861RTX T9-T10-T15-T20-T25-T27-T30-T40
- ⊕ 861TRW 1-2-3-4-5-6 mm
- ⊕ 861TQS 0-1-2-3-4-5-6-8 mm
- ⊕ 861SP 4-6-8-10-12 mm
- 851SR 230 mm
- 900 4-4,5-5-5,5-6-7-8-9-10-11-12-13-14 mm
- 900/21 150 mm 900/25 41 mm
- 900BG/30 176 mm 900/42 115 mm
- Ⓞ 900/55 125 mm 194 1/4x5/16

T91 024240091
~~€ 179,50~~ € 104,00



1/4" 25

- 900 4-4,5-5-5,5-6
 7-8-9-10-11-12
 13-14 mm
- 900ME 2,5-3-4-5-6-8 mm
- 900/20 50 mm
- 900/21 150 mm
- 900/25
- 900BG/30 176 mm
- 900/42 115 mm
- Ⓞ 900/55 125 mm

T92 024240092
~~€ 214,50~~ € 124,00



3/8" 22

- 910A 6-7-8-9-10-11-12
 13-14-15-16-17-18
 19-20-21-22 mm
- 910/21 125 mm
- 910/22 250 mm
- 910/25
- 910/42 210 mm
- Ⓞ 910/55 200 mm

Termoformati morbidi

T103  024240103
~~€ 238,00~~ € 138,00



- 900L 6-7-8-9-10-11-12 mm
- 920AL 13-14-16-17-18-19-21-22-24-27 mm

T131  024240131
~~€ 86,00~~ € 49,00



- 1084BM 160 mm
- 1150BM 180 mm
- 1166BM 160 mm

T145  024240145
~~€ 95,50~~ € 55,00



- 1032 180 mm
- 1034 170 mm
- 1036 175 mm
- 1038 175 mm

T153  024240153
~~€ 60,00~~ € 34,50



- 1048 250 mm
- 1052 240 mm

T199  024240199
~~€ 44,00~~ € 25,50



- 1260 2,5x50 - 3x75 - 3,5x100 - 4x125 - 5,5x100 - 5,5x150-6,5x150 mm

T202  024240202
~~€ 41,00~~ € 23,50



- 1262 PH0x60 - PH0x100 - PH1x80 - PH1x120 - PH2x100 - PH2x150 mm

T205  024240205
~~€ 59,50~~ € 34,50



- 1267TX T6-T7-T8-T9-T10-T15-T20

T210  024240210
~~€ 31,50~~ € 18,00



- 1201 2,5x50-3x75-3,5x100-4x125- 5,5x100-5,5x150 6,5x150mm

T212  024240212
~~€ 34,00~~ € 19,50



- 1202 PH0x60-PH1x80 - PH1x120-PH2x100 - PH2x150-PH3x150 mm

T215  024240215
~~€ 44,50~~ € 25,50



- 1207TX T6-T7-T8-T9-T10-T15-T20

T234  024240234
~~€ 73,50~~ € 42,50

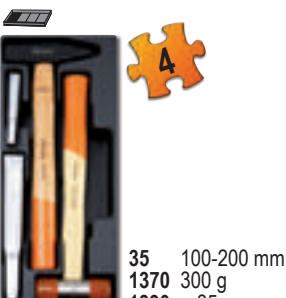

- 35 100-200 mm
- 1370 300 g
- 1390 ø 35 mm

T236  024240236
~~€ 73,00~~ € 42,00

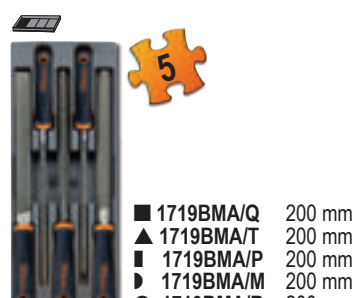

- 1719BMA/Q 200 mm
- ▲ 1719BMA/T 200 mm
- 1719BMA/P 200 mm
- ▶ 1719BMA/M 200 mm
- 1719BMA/R 200 mm

T239  024240239
~~€ 98,50~~ € 56,50

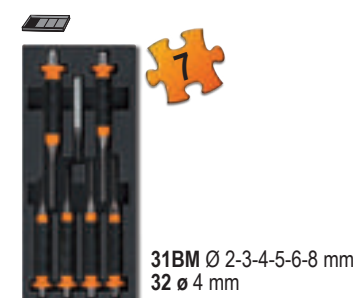

- 31BM Ø 2-3-4-5-6-8 mm
- 32 ø 4 mm

42/SP15

Serie di 15 chiavi combinate con supporto

☞ 6-7-8-9-10-11-12-13-14-15
16-17-19-22-24 mm



000420078

~~€ 145,50~~ € 82,50

55/SP7

Serie di 7 chiavi a forchetta doppie con supporto

☞ 6x7-8x9-10x11-12x13-14x15
16x17-18x19 mm



000550167

~~€ 41,00~~ € 23,50

42/SC9I

Serie di 9 chiavi combinate con supporto compatto

☞ 8-10-11-12-13-14-15-17-19 mm



000420087

~~€ 85,50~~ € 49,00

142/SC9I

Serie di 9 chiavi combinate a cricchetto reversibile con supporto compatto

☞ 8-10-11-12-13-14-15-17-19 mm



001420087

~~€ 173,00~~ € 99,00

142SN/SC9

Serie di 9 chiavi combinate a cricchetto snodate con supporto compatto

☞ 8-10-11-12-13-14-15-17-19 mm



001420259

~~€ 207,00~~ € 119,50

Chiavi di manovra

90/S7

Serie di 7 chiavi poligonali doppie curve

6x7-8x9-10x11-12x13-14x15-16x17-18x19 mm

000900163

~~€ 72,00~~ € 41,50



192/S2

Serie di 2 chiavi poligonali a cricchetto reversibile

001920070

~~€ 52,50~~ € 30,00

8 misure in 2 chiavi



195/B5

Serie di 5 chiavi poligonali doppie diritte a cricchetto, in busta

8x10-12x13-14x15-16x18-17x19 mm

001950066

~~€ 108,50~~ € 62,00



88/S7

Serie di 7 chiavi poligonali doppie diritte extralunghe

Extralunghe



000880107

~~€ 159,00~~ € 91,00

mm	L mm
8x10	235
12x14	330
13x15	330
16x18	405
17x19	405
21x23	435
22x24	435

42INOX/SC9

Serie di 9 chiavi combinate in acciaio inossidabile con supporto compatto

Beta
INOX
STAINLESS STEEL

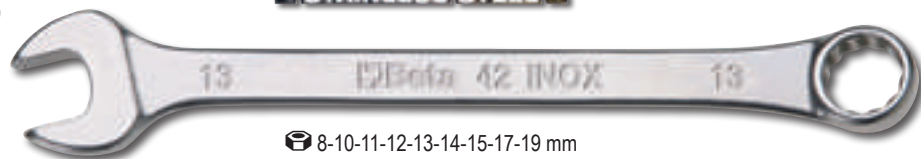

8-10-11-12-13-14-15-17-19 mm

000420387

~~€ 146,00~~ € 84,00



111

Chiavi regolabili a rullino cromate con scala graduata

- Apertura della ganaschia mobile con rotazione destrorsa del rullino
- Scala millimetrata e in pollici



	L mm	A max.		€	
111/100	100	15 mm	001110010	€ 19,00	€ 11,00
111/150	150	24 mm	001110015	€ 20,00	€ 11,50
111/200	200	28 mm	001110020	€ 24,00	€ 13,80
111/250	250	34 mm	001110025	€ 29,50	€ 17,00
111/300	300	35 mm	001110030	€ 39,00	€ 22,50

Doppia lettura mm-pollici



933/S7

Serie di 7 chiavi a pipa doppie esagonali

○ 8-10-11-12-13-17-19 mm



009330077

~~€ 115,50~~ € 66,00

933/S12

Serie di 12 chiavi a pipa doppie esagonali

○ 8-10-11-12-13-14-16-17-18-19-22-24 mm



009330089

~~€ 240,00~~ € 138,00

944BX/D6

Serie di 6 chiavi a bussola esagonale profonda tipo lungo

○ 5-6-7-8-10-13 mm

Betamax



009440056

~~€ 97,50~~ € 56,00



952/D7

Serie di 7 chiavi a T con bussola esagonale snodata

○ 7-8-10-12-13-14-17 mm

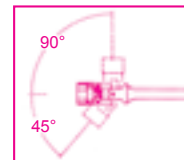
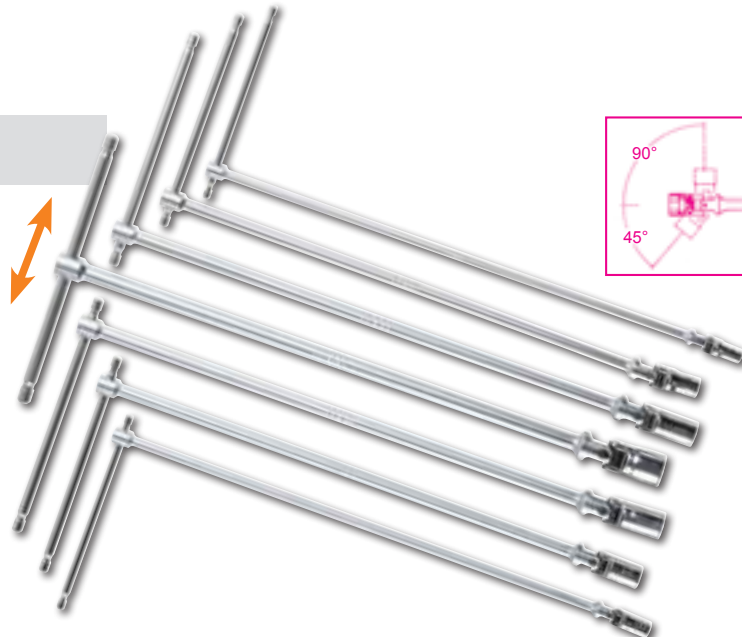

009520079

~~€ 193,00~~ € 110,00

Chiavi maschio

96T/S5P



Serie di 5 chiavi maschio esagonale piegate con impugnatura

○ 2,5-3-4-5-6 mm

000960946

~~€ 50,00~~

€ 28,50



951/S6



Serie di 6 chiavi a T con tre estremità maschio esagonale

○ 2,5-3-4-5-6-8 mm

009510687

~~€ 100,00~~

€ 57,00

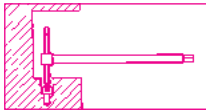

97TTX/S6



Serie di 6 chiavi maschio piegate per viti con impronta Torx® con impugnatura

○ T10-T15-T20-T25-T30-T40

000970791

~~€ 70,50~~

€ 38,50



852 1/4



Portainseri a T snodato

008520006

~~€ 31,00~~

€ 17,50



Novità

L 400 mm



96BP-CO/SC9

Serie di 9 chiavi maschio esagonale piegate colorate con un'estremità sferica

Ø mm	L mm
1,5	91
2	100
2,5	113
3	130
4	142
5	163
6	185
8	205
10	231

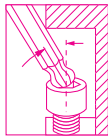

000961519

€ 44,00

€ 24,50

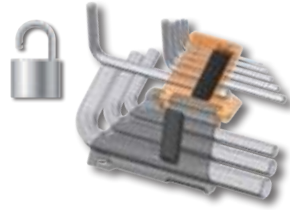

96/SC9

Serie di 9 chiavi maschio esagonale piegate

Ø mm	L mm
1,5	42
2	48
2,5	59
3	62
4	70
5	81
6	92
8	102
10	116



000960374

€ 16,40

€ 9,30

96BPC/SC9

Serie di 9 chiavi maschio esagonale piegate con un'estremità sferica

Ø mm	L mm
1,5	79
2	85
2,5	89
3	100
4	110
5	129
6	152
8	173
10	194

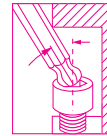

000960354

€ 35,50

€ 17,50

Modello extra lungo +30%

96LBP/SC9

Serie di 9 chiavi maschio esagonale piegate con un'estremità sferica

Ø mm	L mm
1,5	91
2	100
2,5	113
3	130
4	142
5	163
6	185
8	205
10	231



000961354

€ 40,50

€ 22,80

97BTX/SC8

Serie di 8 chiavi maschio piegate con un'estremità sferica per viti con impronta Torx®

Ø mm	L mm
T9	65
T10	74
T15	84
T20	96
T25	98
T27	109
T30	123
T40	136

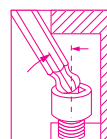

000970164

€ 61,50

€ 33,50

97BTXL/SC8

Serie di 8 chiavi maschio piegate con un'estremità sferica, modello lungo per viti con impronta Torx®

Ø mm	L mm
T9	83
T10	89
T15	103
T20	114
T25	130
T27	145
T30	166
T40	183

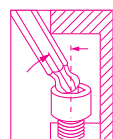

000970364

€ 70,50

€ 38,50

Modello extra lungo +30%

Modello extra lungo +25%

Novità

Novità



335x145x60 mm



867/C20

Assortimento di 18 inserti con impronta RIBE® con attacco esagonale 10 mm e 2 accessori in termoformato morbido e cassetta di lamiera

	867/1	L 38 mm	○ 10 mm - □ 3/8
	867/2	L 38 mm	○ 10 mm - □ 1/2
	867RIBE	○ L 30 mm	5-6-7-8 -9-10 -11-12-13 mm
	867RIBE/L	○ L 75 mm	5-6-7-8 -9-10 -11-12-13 mm

008670920

€ 241,50 € 138,00

Nuovo portainseriti a T snodato

Novità

852

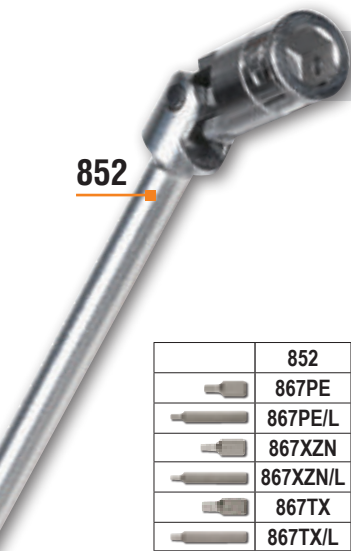

867/C38



Assortimento di 38 inserti con attacco esagonale 10 mm e 1 portainseriti a T snodato in termoformato morbido cassetta in lamiera



008670938

€ 159,00 € 91,00

420x185x60 mm

	852	○ L 400 mm	10 mm
	867PE	○ L 30 mm	4-5-6-7-8-10-12 mm
	867PE/L	○ L 75 mm	4-5-6-7-8-10-12 mm
	867XZN	○ L 30 mm	M5-M6-M8-M10-M12
	867XZN/L	○ L 75 mm	M5-M6-M8-M10-M12
	867TX	○ L 30 mm	T20-T25-T30-T40-T45-T50-T55
	867TX/L	○ L 75 mm	T20-T25-T30-T40-T45-T50-T55

860/C27



Serie di 25 inserti colorati con raccordo e cricchetto reversibile in astuccio tascabile

- 860LP 0,5x3-1,0x5,5-1,2x6,5 mm
- 860PE 2-2,5-3-4-5-6-mm
- 860PH PH1-PH2(x2)-PH3
- 860TX T6-T8-T10-T15-T20-T25-T30-T40
- 860PZ PZ1 - PZ2(2x) - PZ3
- 860/55 100 mm
- 892/0

cricchetto interamente in acciaio



008600880

€ 69,00 € 39,50

862F/A7



Serie di 7 inserti a bussola esagonale magnetici, in astuccio tascabile

- 862F ○ 5,5-6-7-8-10-12-13 mm



008620950

€ 39,50 € 22,50



1203/D8P

Serie di 8 giravite

1201 ● 2,5x50-3x75-4x100-5,5x100-6,5x150 mm
1202 ⊕ PH0x60-PH1x80-PH2x100 mm

012030018

~~€ 32,50~~ € 18,50



1203/D10N

Serie di 10 giravite

1201 ● 2,5x50-3x75-4x100-5,5x150-6,5x150 mm
1202 ⊕ PH0x60-PH1x80-PH2x100 mm
1201N ● 4x30 mm
1202N ⊕ PH1x30 mm

012030019

~~€ 41,50~~ € 23,50



1207TX/D7

Serie di 7 giravite

1207TX ⊕ T6-T8-T10-T15-T20-T25-T30

012070207

~~€ 42,00~~ € 24,00



1263/D8

Serie di 8 giravite

1260 ● 2,5x50-3x75-4x100- 5,5x125-6,5x150 mm
1262 ⊕ PH0x60-PH1x80- PH2x100 mm

012630008

~~€ 45,00~~ € 25,50



1263/D10

Serie di 10 giravite

1260 ● 3x75-3,5x100-4x125-5,5x150-6,5x150 mm
1262 ⊕ PH0x60- PH1x8-PH2x100 mm
1260N ● 4x30 mm
1262N ⊕ PH1x30 mm

012630010

~~€ 57,50~~ € 32,50



1267TX/D7

Serie di 7 giravite

1267TX ⊕ T6-T8-T10-T15-T20-T25-T30

012670307

~~€ 57,50~~ € 33,00

1293/D8

Serie di 8 giravite

1291 ● 3x75-4x100-5,5x100-6,5x150-8x150 mm
1292 ⊕ PH0x60-PH1x80-PH2x100 mm

012930403

~~€ 63,00~~ € 36,00



1293INOX/D8

Serie di 8 giravite in acciaio inossidabile

1290INOX ● 2,5x50-3x75-4x100-5,5x150-6,5x150 mm
1292INOX ⊕ PH0x60-PH1x80-PH2x100 mm

012930408

~~€ 65,00~~ € 37,50



1273MQ/D6

Serie di 6 giravite isolati

1274MQ ● 3x100-4x100-5,5x125 mm
1272MQ ⊕ PH0x60-PH1x80-PH2x100 mm

012730851

~~€ 54,00~~ € 31,00



⚠ 1000 V ⚡

Estensibile fino al 70%
in più rispetto allo standard

920/55L

12"

72

Cricchetto estensibile reversibile
con attacco quadro maschio 1/2"
meccanismo a 72 denti

- Sistema di blocco dell'impugnatura



7 differenti lunghezze
Da 280 a 422 mm

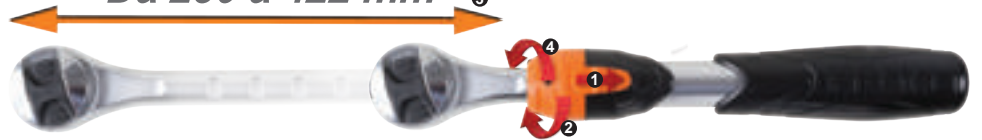

009200927

€ 84,50

€ 48,00

1/4"

3/8"

1/2"

Cricchetto reversibile
con impugnatura rotante

- Sistema di inversione a ghiera sulla testa del cricchetto
- Impugnatura bimatériale

Avvicinamento rapido
del quadro
con la sola rotazione
dell'impugnatura

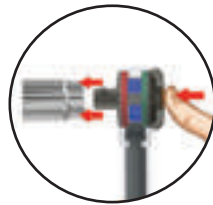

Pulsante di rilascio
della bussola

A mm

Ø mm

	L mm	Ø mm	A mm	■	📄	€	
900/58	126	28	28,5	1/4"	009000884	€ 57,00	€ 32,50
910/58	222	37	38,5	3/8"	009100884	€ 62,50	€ 36,00
920/58	281	42,5	45	1/2"	009200926	€ 73,00	€ 41,50

1/4"

3/8"

1/2"

3/4"

Cricchetto reversibile cromato



A mm

Ø mm

40

72

72

72

	L mm	Ø mm	A mm	■	📄	€	
900/55	125	25	18	1/4"	009000870	€ 37,00	€ 21,50
910/55	200	30	33	3/8"	009100882	€ 41,00	€ 23,50
920/55	275	40	43	1/2"	009200882	€ 49,50	€ 28,50
928/55	510	58	59	3/4"	009280862	€ 129,00	€ 74,00



Assortimento di 11 chiavi a bussola esagonali, 21 inserti e 7 accessori in cassetta di plastica

900/C39



con cricchetto reversibile (900/55)

009000937

~~€ 159,50~~ € 91,00

900/C39-R



con cricchetto reversibile manico rotante (900/58)

009000938

~~€ 183,00~~ € 103,00

	861LP	●	0,6x4,5-1,2x6,5-1,2x8 mm
	861PE	○	2,5-3-4-5-6 mm
	861PH	⊕	PH1-PH2-PH3
	861PZ	⊕	PZ1-PZ2-PZ3
	861RTX	⊗	T10-T15-T20-T25-T27-T30-T40 mm
	892/0	●	1/4" - 1/4"
	895/1	○	1/4" - 1/4"
	900	○	5-5,5-6-7-8-9-10-11-12-13-14 mm
	900/20		50 mm
	900/20L		100 mm
	900/25		
	900BG/30C		



Assortimento di 12 chiavi a bussola esagonali, 20 inserti per avvitatori e 7 accessori in termoformato morbido, in cassetta di lamiera

900/C12M



con cricchetto reversibile (900/55)

009000963

~~€ 177,50~~ € 102,00

900/C12MR



con cricchetto reversibile manico rotante (900/58)

009000962

~~€ 197,00~~ € 113,00



350x150x50 mm

	861LP	●	0,5x3-0,8x5,5-1x5,5-1,2x6,5 mm
	861PE	○	3-4-5-6-8 mm
	861PH	⊕	PH0-PH1-PH2-PH3
	861TX	○	T8-T10-T15-T20-T25-T30-T40
	895/1	○	1/4" - 1/4"
	900	○	4-5-5,5-6-7-8-9-10-11-12-13-14 mm
	900/20		50 mm
	900/21		150 mm
	900/25		
	900/42		
	900BG/30		



902A/C22



Assortimento di 22 chiavi a bussola esagonali, e 6 accessori in cassetta di lamiera

1/4"		900	○	5-5,5-6-7-8-9-10-11-12-13 mm
		900/20		50 mm
		900/25		
		900/55	⊗	
1/2"		920A	○	10-13-14-15-17-18-19-22-24-27-30-32 mm
		920/21		125 mm
		920/25		
		920/55	⊗	

009020807

~~€ 293,00~~ € 167,50



420x185x60 mm

Chiavi a bussola

38"



Assortimento di 16 chiavi a bussola esagonali e 5 accessori in cassetta di lamiera

910A/C16



con cricchetto reversibile (910/55)

009100936

~~€ 217,50~~ € 123,50



335x145x60 mm

	910A	6-7-8-9-10-11-12-13-14 15-16-17-18-19-21-22 mm
	910/21	125 mm
	910/22	250 mm
	910/25	
	910/42	

910A/C16HR



con cricchetto reversibile manico rotante (910/58)

009100935

~~€ 239,00~~ € 134,50

12"



Assortimento di 17 chiavi a bussola esagonali e 5 accessori in termoformato morbido, in cassetta di lamiera

920A/C17M



con cricchetto reversibile (920/55)

009200924

~~€ 264,00~~ € 151,00



420x185x60 mm

	920A	10-11-12-13-14-15-16-17-18-19 20-21-22-24-27-30-32 mm
	920/21	125 mm
	920/22	255 mm
	920/25	
	920/42	

920A/C17MR



con cricchetto reversibile manico rotante (920/58)

009200937

~~€ 287,00~~ € 162,00

928A/C12

34"



Assortimento di 12 chiavi a bussola esagonali e 5 accessori in cassetta di lamiera

	928A	22-24-27-30-32-34-36-38-41 46-50-55 mm
	928/21	200 mm
	928/22	380 mm
	928/25	
	928/42	
	928/55	

009280955

~~€ 641,00~~ € 368,00

530x220x80 mm



605E 1/4"

precisione di serraggio $\pm 6\%$
per serraggi destrorsi e sinistrorsi



UNI EN 26789 ISO 6789



	Nm	kgfm	lbf.ft	■	L (mm)	g		€	
605E/5	1÷5	0,1÷0,5	10÷45	1/4"	190	180	006050105	€ 168,00	€ 97,00
605E/10	2÷10	0,2÷1,0	18÷90	1/4"	190	180	006050110	€ 178,00	€ 103,00

666N 1/4" 3/8"



Novità

Precisione di serraggio $\pm 3\%$
per serraggi destrorsi e sinistrorsi

- Scala più grande del 60% per garantire una migliore visibilità e un settaggio più accurato
- Velocità di regolazione della coppia aumentata del 40%
- Materiale dell'impugnatura e lente resistenti a tutte le sostanze chimiche utilizzate nell'automotive, nell'industria e nell'aviazione



UNI EN 26789 ISO 6789



	Nm	kgfm	lbf.ft	■	L (mm)	g		€	
666N/2	5÷25	0,5÷2,5	4÷18	1/4"	215	300	006660002	€ 255,00	€ 145,00
666N/2X	5÷25	0,5÷2,5	4÷18	3/8"	215	300	006660003	€ 260,00	€ 148,00

606 3/8" 1/2"



Precisione di serraggio $\pm 4\%$
per serraggi destrorsi



UNI EN 26789 ISO 6789



	Nm	kgfm	lbf.ft	■	L (mm)	g		€	
606/6	8÷60	0,8÷6	6÷44	3/8"	305	595	006060105	€ 182,00	€ 105,00
606/10X	20÷100	2÷10	15÷80	1/2"	345	680	006060111	€ 188,00	€ 108,00
606/20	40÷200	4÷20	30÷150	1/2"	440	920	006060120	€ 200,00	€ 115,00
606/30	68÷330	6÷33	40÷250	1/2"	560	1180	006060130	€ 228,00	€ 131,00

Dinamometria



677/C

3/4"

Chiave dinamometrica a disinnesto in cassetta

Precisione di serraggio $\pm 4\%$ per serraggi destrorsi e sinistrorsi



UNI EN 26789 ISO 6789

677/C100

	Nm	kgfm	lbf.ft	■	L (mm)	kg		€	€
677/C50	100÷500	10÷50	70÷350	3/4"	915	5,2	006770606	€ 735,00	€ 425,00
677/C70	150÷700	15÷70	100÷500	3/4"	1140	6,2	006770611	€ 765,00	€ 442,00
677/C100	300÷1000	30÷100	200÷750	3/4"	1470	7,5	006770615	€ 893,00	€ 515,00



599DGT-A

12"

Chiave dinamometrica elettronica a lettura di coppia e angolo per serraggi destrorsi (precisione $\pm 2\%$) e sinistrorsi (precisione $\pm 3\%$), in cassetta di plastica

Lettura d'angolo fino a 360°



Coppia +angolo



UNI EN 26789 ISO 6789

- Strategia di serraggio: coppia + angolo
- Software interno per la memorizzazione dei dati:
- Cricchetto reversibile: serraggio destrorso e sinistrorso
- Doppia modalità di misura: picco e traccia
- Doppia segnalazione di avvicinamento e arresto: i led verdi e successivamente quelli rossi abbinati ad un segnalatore acustico avvisano l'utente del raggiungimento della coppia o dell'angolo impostati
- Impugnatura bimatereale antiscivolo
- Alimentazione: 2 batterie AA - 1,5V incluse

Software e cavo USB per scaricare i dati sul PC



	Nm	∠	kgfm	lbf.ft	■	L (mm)		€	€
599DGT-A/10	20÷100	0÷360°	2÷10	15÷80	1/2"	413	005990510	€ 570,00	€ 330,00
599DGT-A/20	40÷200	0÷360°	4÷20	30÷150	1/2"	520	005990520	€ 610,00	€ 350,00



561/1 *Compatto e leggero*

Moltiplicatore di coppia rapporto 5:1 con due piedi di reazione

- Fornito con leva diritta e piede a 90°
- Ideale per l'utilizzo in spazi ristretti (\varnothing corpo 65 mm)
- Estremamente leggero (1,5 kg)
- Permette il serraggio destrorso e sinistrorso
- Precisione di serraggio: $\pm 4\%$

$\varnothing 65 \text{ mm}$

Novità



005610010

~~€ 990,00~~ **€ 570,00**

1169BM/D3

Assortimento di 1 pinza universale,
1 pinza becchi mezzotondi lunghi
e 1 tronchese



011690123

~~€ 75,00~~ € 43,00



1082BM 160 mm



1166BM 160 mm

1150BM 180 mm

1169MQ/D2

Assortimento di 1 pinza
universale isolata
e 1 tronchese isolato

1000 V

011690143

~~€ 77,50~~ € 44,50



1150MQ 180 mm



1182MQ 160 mm



1009L/DP-S2

Serie di 2 pinze a becchi mezzotondi
lunghissimi zigrinati con doppio snodo



L 340 mm



1009L/DP

1009L/D

010090060

~~€ 55,00~~ € 31,50



1052

Pinze regolabili
autobloccanti
ganasce concave

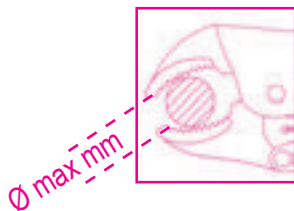

	L mm	Ø Max mm		€	
1052/140	140	22	010520014	€ 21,00	€ 12,00
1052/190	190	36	010520019	€ 23,70	€ 13,50
1052/240	240	42	010520024	€ 25,00	€ 14,50

1047/240

Pinza regolabile a pulsante

- Regolazione rapida e precisa mediante la pressione del pulsante
- Nessuno spostamento accidentale della regolazione
- Trattamento termico localizzato sulle ganasce



010470240

~~€ 36,50~~ € 21,00

L 240 mm Ø Max 36 mm Max 32 mm

1048

Pinze regolabili cerniera chiusa

- Manici ricoperti con 2 strati di PVC antiscivolo



L 250 mm

9 posizioni



010480015

~~€ 28,00~~ € 16,00

1031/S4

Serie di 4 pinze per anelli elastici di sicurezza



1038 175 mm
● 19 ÷ 60 mm

1036 175 mm
● 19 ÷ 60 mm

1032 180 mm
○ 19 ÷ 60 mm

010310000

~~€ 86,00~~ € 49,00

1034 170 mm
○ 19 ÷ 60 mm

38/B6

Serie di 2 punzoni, 1 bulino, 2 scalpelli piatti e 1 ugnetto in busta

000380006

~~€ 52,00~~ € 30,00



30: Ø 2-3 mm

32: Ø 4 mm

34: 125-150 mm

36: 150 mm



32AU

Bulino automatico con corpo brunito

- Forza d'urto regolabile fino a 50 Kg
- Utilizzabile con una sola mano

000320160

~~€ 44,00~~ € 26,00

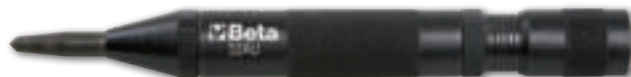

L 150 mm



1370

Martello tipo tedesco per meccanici manico in legno

	g		€	
1370/200	200	013700052	€ 10,40	€ 6,00
1370/300	300	013700053	€ 12,00	€ 7,00
1370/400	400	013700054	€ 13,50	€ 8,00
1370/500	500	013700055	€ 14,60	€ 8,50
1370/600	600	013700056	€ 16,90	€ 10,00
1370/800	800	013700058	€ 19,00	€ 11,00
1370/1000	1000	013700060	€ 22,30	€ 13,00
1370/1500	1500	013700065	€ 26,00	€ 15,00

1390

Mazzuole con battenti intercambiabili in materiale plastico manico in legno

	Ø mm		€	
1390/22	22	013900022	€ 14,50	€ 8,40
1390/28	28	013900028	€ 18,00	€ 10,40
1390/35	35	013900035	€ 24,00	€ 13,80
1390/45	45	013900045	€ 39,00	€ 22,50
1390/60	60	013900060	€ 66,50	€ 38,50

1380

Mazzette manico in legno

	g		€	
1380/800	800	013800208	€ 16,50	€ 9,50
1380/1000	1000	013800210	€ 18,00	€ 10,50
1380/1250	1250	013800212	€ 19,00	€ 11,00
1380/1500	1500	013800215	€ 21,50	€ 12,50
1380/2000	2000	013800220	€ 28,00	€ 16,00

Forare e Filettare

412/SP19P

Serie di 19 punte elicoidali cilindriche, in acciaio HSS, rettificata lucide
 $\varnothing 1\pm 10 \times 0,5 \text{ mm}$

R \leq 700 N/mm²
 HV \approx 750÷820

115x170x40 mm

004120429

~~€ 51,00~~ € 29,50



415CO/SP19A

Serie di 19 punte elicoidali cilindriche, in acciaio HSS-CO 5%
 • Per forare acciaio INOX, acciai legati, ghisa, acciai dolci, leghe leggere
 $\varnothing 1\pm 10 \times 0,5 \text{ mm}$

R \leq 1400 N/mm²
 HV \approx 850÷920

115x170x40 mm

004150440

~~€ 108,00~~ € 62,50



425E/SP3

Novità

Serie di 3 frese coniche elicoidali a gradino in acciaio HSS, con affilatura più efficace
 $\varnothing 4\pm 12 ; 4\pm 20 ; 4\pm 30 \text{ mm}$

004250600

~~€ 190,00~~ € 110,00



437U/09

Kit di ripristino delle filettature danneggiate

M5X0,8
 M6X1,0
 M8X1,25
 M10X1,5
 M12X1,75

004370550

~~€ 265,00~~ € 152,00

370x230x55 mm



446/C110

Assortimento di 105 maschi e filiere con 5 accessori in acciaio al cromo, filettatura metrica in cassetta di legno

430 M mm	433 M mm	440/440A M mm	441/441A M mm
2x0,4	6x0,75 - 7x0,75	2x0,4	6x0,75 - 7x0,75
3x0,5	8x0,75 - 8x1	3x0,5	8x0,75 - 8x1
4x0,7	9x0,75 - 9x1	4x0,7	9x0,75 - 9x1
5x0,8	10x0,75 - 10x1	5x0,8	10x0,75 - 10x1
6x1	10x1,25 - 11x0,75	6x1	10x1,25 - 11x0,75
7x1	11x1 - 11x1,25	7x1	11x1 - 11x1,25
8x1,25	12x0,75 - 12x1	8x1,25	12x0,75 - 12x1
9x1,25	12x1,25 - 12x1,5	9x1,25	12x1,25 - 12x1,5
10x1,5	14x1 - 14x1,25	10x1,5	14x1 - 14x1,25
11x1,5	14x1,5 - 16x1	11x1,5	14x1,5 - 16x1
12x1,75	16x1,5 - 18x1,5	12x1,75	16x1,5 - 18x1,5
14x2		14x2	
16x2		16x2	

435/0 444/1 436/1
 435/3 444/2

004460060

~~€ 690,00~~ € 395,00

500x337x60 mm



BREVETTATO

1128BAX

Forbici per elettricisti a doppio effetto, con profili a fresa in acciaio inossidabile rivestito in DLC



+durezza
-coefficiente d'attrito

Rivestimento DLC:

Il DLC (diamond-like carbon) è un rivestimento innovativo a base di carbonio: l'elevata durezza ed il basso coefficiente d'attrito nascono dalla simultanea presenza di carbonio depositato sulla superficie in forma di Grafite e Diamante.

- Alta durezza superficiale delle lame (resistenza all'abrasione e mantenimento dell'affilatura nel tempo)
- Basso coefficiente di attrito (scorrevolezza e potenza di taglio)
- Fornite con custodia plastica snodata

011280088

~~€ 24,50~~ € 14,00



Profilo e fresa: studiate per allargare fori su plastica da 13 a 25 mm.

Taglio a doppio effetto:

-sforzo +potenza

una speciale camma sul fulcro riduce del 20% lo sforzo di taglio.



1726

Seghetto con sistema di tensionamento della lama incorporato nell'impugnatura

- archetto in acciaio verniciato
- impugnatura in lega di alluminio con sistema di tensionamento incorporato

017260001

~~€ 22,50~~ € 13,00



1771

Cutter 18 mm con blocco automatico della lama, con struttura interna in acciaio inossidabile fornito con 3 lame

017710000

~~€ 7,50~~ € 4,30



1778V18

Coltello a serramanico impugnatura in alluminio in astuccio

017780018

~~€ 24,00~~ € 13,50

Novità



Calibro digitale a corsoio in acciaio inossidabile temprato in astuccio rigido di materiale plastico

- lettura centesimale
- bloccaggio a vite del corsoio
- conversione mm/pollici

DIN 862

UNI EN ISO 13385-1



A Max 150 mm L 225 mm

1651DGT/150

016510111

~~€ 102,00~~

€ 59,00

A Max 200 mm L 285 mm

1651DGT/200

016510112

~~€ 117,00~~

€ 67,00

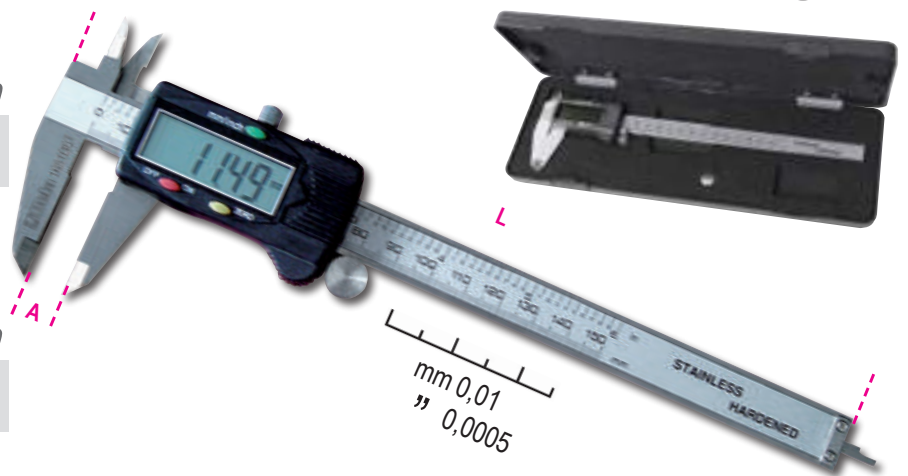

1691BM

Flessometri cassa bimateriale in ABS antiurto nastro in acciaio classe di precisione II



	L m	S mm		€	
1691BM/5	5	25	016910205	€ 12,80	€ 7,20
1691BM/8	8	32	016910208	€ 18,70	€ 10,50
1691BM/10	10	32	016910210	€ 22,60	€ 12,80

1430/S8

Serie di 8 estrattori conici per viti e prigionieri danneggiati destrorsi in astuccio di plastica

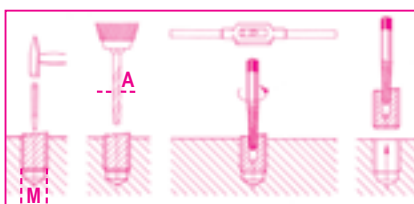

014300108

~~€ 65,00~~

€ 38,00

	M	A mm
1430/1	3÷6	2,5
1430/2	6÷8	3,0
1430/3	8÷11	4,5
1430/4	11÷14	6,0
1430/5	14÷18	8,0
1430/6	18÷24	11,0
1430/7	24÷33	14,0
1430/8	33÷50	21,0



1511

Estrattori a due griffe reversibili per esterni

- estremità delle griffe con due differenti profili.
- le estremità ad unghia favoriscono la rimozione iniziale di organi con limitate possibilità d'aggancio, l'estrazione si completa utilizzando l'altro profilo.
- la staffa intermedia aiuta nel serraggio del pezzo impedendone lo svincolo.
- le griffe sono forate per posizionare al meglio l'estrattore.

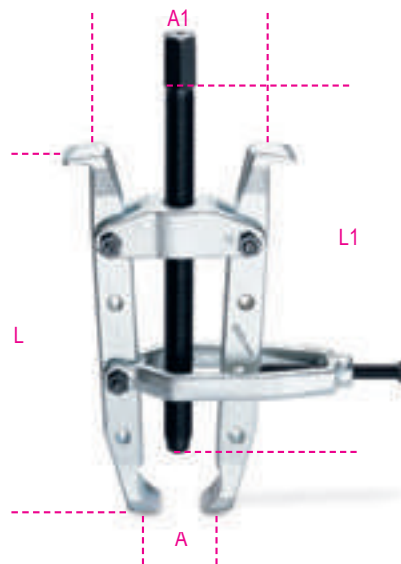

	A min÷Max	L mm	L1 mm	● mm	A1 min÷Max mm	Carico Max kg		€	
1511/1	20÷100 mm	235	230	19	65÷95	5000	015110001	€ 200,00	€ 116,00
1511/2	40÷150 mm	330	340	22	103÷190	10000	015110002	€ 250,00	€ 145,00
1511/3	40÷150 mm	405	400	22	103÷175	10000	015110003	€ 310,00	€ 179,00

1500

Estrattori universali a 2 griffe

- impiego sia per esterni che per interni.
- griffe mobili lungo la traversa con dadi di bloccaggio.

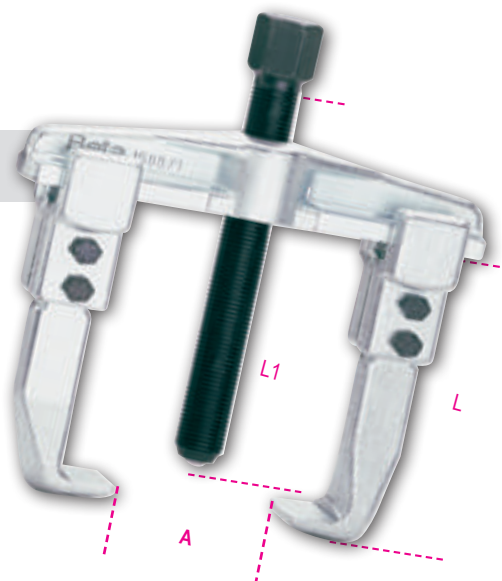
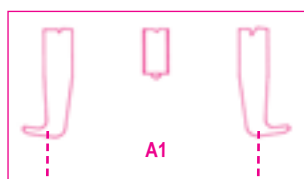

	A min÷Max	L mm	L1 mm	● mm	A1 min÷Max mm	Carico Max kg		€	
1500/1	25÷80 mm	100	135	17	70÷130	4500	015000301	€ 66,00	€ 38,00
1500/2	25÷130 mm	100	135	17	80÷180	4500	015000302	€ 69,00	€ 40,00
1500/3	50÷160 mm	150	210	22	105÷220	6000	015000303	€ 113,00	€ 65,50
1500/4	60÷200 mm	150	210	22	120÷270	6000	015000304	€ 158,00	€ 91,50

1428/SB11

Serie di 11 estrattori a bussola per dadi danneggiati con supporto

38" 8-10-11-12-13-14 mm **12"** 15-16-17-18-19 mm



014280111

~~€ 170,50~~ **€ 98,50**

Estrattori combinati in cassetta di lamiera

- combinazione di tiranti 1533, prolunghe 1533PR e separatori 1534.

1533PR

1533

1534



1535/C1

	L mm	A min÷Max
1533PR/1	100	
1533/2	150	45÷130 mm
1534/1	88	5÷60 mm

260x180x40 mm

015350001

~~€ 235,50~~ € 135,00

1535/C2

	L mm	A min÷Max
1533PR/1	100	
1533/2	150	45÷130 mm
1534/2	118	12÷75 mm

260x180x40 mm

015350002

~~€ 249,00~~ € 144,00

1535/C3

	L mm	A min÷Max
1533PR/2	100	
1533/3	210	85÷225 mm
1534/3	160	22÷115 mm

380x280x55 mm

015350003

~~€ 434,00~~ € 249,00

1547/C6

Estrattori per cuscinetti con false sfere in cassetta di lamiera

- utilizzabile solo dopo aver "sgabbiato" le sfere.



015470006

~~€ 220,50~~ € 127,00



Cuscinetti:

1547/1

6011-6014, 6206-6211, 6303-6308, 6403-6405

1547/2

6004-6010, 6200-6205, 6300-6304

420x185x60 mm



1545/C5M

Estrattore 1542/1 con 5 Espansori 1544 in cassetta di lamiera

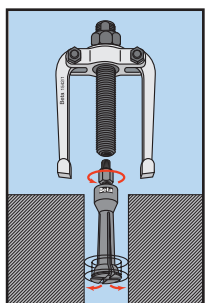

015450011

~~€ 418,00~~ € 241,00



420x185x60 mm

	A mm	C mm
1544/1	9÷12	0,80
1544/2	13÷17	1,15
1544/3	16÷21	1,70
1544/4	20÷25	1,65
1544/5	25÷30	2,00

378

Giratubi modello svedese
con ganasce sottili a 45°
in acciaio forgiato



	L mm	Ø Max	Ø Max		€	
378/320	320	1" gas	34 mm	003780032	€ 41,50	€ 24,00
378/410	410	1"1/2 gas	49 mm	003780041	€ 54,00	€ 31,00
378/550	550	2" gas	60 mm	003780055	€ 87,00	€ 50,00

360

Giratubi modello Stillson
in acciaio forgiato



	L mm	Ø Max	Ø Max		€	
360/350	350	1"1/2 gas	49 mm	003600035	€ 37,50	€ 21,50
360/450	450	2 gas	60 mm	003600045	€ 52,00	€ 30,00
360/600	600	2"1/2 gas	76 mm	003600060	€ 79,00	€ 45,50

334

Tagliatubi per rame
e leghe leggere



Con lama svasatubi

003340001

~~€ 23,80~~ **€ 13,80**

Ø 3÷30 mm
1/8"÷1"1/8

351C

Tagliatubi ed attrezzo bordatubi
in cassetta di materiale plastico



351P Ø 4-4,75-6-8-10-12-14 mm

- L'assortimento di sette puntali permette, di realizzare una bordatura doppia a 45°

003510010

~~€ 117,00~~ **€ 67,50**

225x150x45 mm



334 Ø 3÷30 mm
1/8"÷1"1/8



350 Ø 4÷14 mm

342

Cesoia a cricchetto
per tubi in materiale plastico

003420030

~~€ 39,50~~ € 23,00



Ø 0÷42 mm
1"5/8

388C/C8

Attrezzo curvatubi
con 7 matrici in alluminio
per rame ricotto e lega leggera
in cassetta di plastica



400x330x110 mm

003880200

~~€ 368,00~~ € 212,00



Ø mm 10,12,14,16,18,20,22

345C

Novità

Calibratore per tubi multistrato

003450032

~~€ 35,00~~ € 20,50



186 8-32

Chiave autoserrante
a ripresa automatica
per esagoni da 8 a 32 mm

Ideale per viti con testa a profilo: esagonale,
Spline®, quadrato, Torx®; anche rovinate.

001860008

~~€ 39,50~~ € 22,50



L 260 mm

*Efficace anche
su viti usurate*

SPLINE® 12 lati quadrato Torx® esagonale teste rovinate al 70%

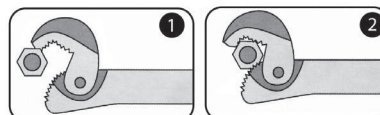

1149F

Spellature rapide e precise

Pinza spellafili frontale autoregolabile, con dispositivo di taglio

- Adattamento automatico ai diametri dei conduttori
- Lunghezza della spellatura regolabile
- Regolazione della pressione di taglio isolante
- Dispositivo di taglio integrato



0,2÷6 mm²

011490010

~~€ 13,50~~ € 7,80

1606A/C9

Pinza per capicorda a tubetto con assortimento di 450 capicorda da 0,5 mm² a 6 mm²



016060100

~~€ 134,50~~ € 77,00

420x350x35 mm

1609B

Pinza crimpatrice meccanica

- Per capicorda in rame non isolati da 10 a 120 mm²
- Impugnatura in gomma antiscivolo
- Perno interno con sezione ad "H" per la massima scorrevolezza del punzone
- In acciaio brunito



10÷120 mm²



L 600 mm

016090101

~~€ 245,00~~ € 142,00

1256/C36-2

per lavori di precisione

Microgiravite bimateriale con 36 inserti intercambiabili da 4 mm e prolunga magnetica

130x60x35 mm

	1256TX	⊙	T3-T4-T5-T6-T7-T8-T9-T10-T15
	1256RTX	⊕	T6-T7-T8-T9-T10
	1256LP	●	0,8-1,2-1,5-1,8-2-2,5-3-3,5-4 mm
	1256PE	○	0,7-0,9-1,3-1,5-2 mm
	1256PH	⊕	PH000-PH00-PH0-PH1
	1256PZ	⊕	PZ000-PZ00-PZ0-PZ1
	1256/20		
	1256/30		

012560100

~~€ 53,00~~ € 30,50



1760/RMS



A prova di caduta da 2 m

Multimetro digitale industriale con gomma esterna antiscivolo ed antiurto

- Ingressi protetti
- Autoranging
- Ampio display di immediata lettura, retroilluminato blu
- Sonda temperatura tipo K (inclusa)
- Autospegnimento
- Base in gomma portaterminale per un maggiore comfort durante l'uso
- Terminali a doppio isolamento 1000V, lunghezza 1 m
- In custodia morbida
- CAT IV 600V/ CAT III 1000V
- Vero valore efficace TRUE RMS



017600020

~~€ 232,00~~ € 135,00

Tensione AC/DC
Corrente AC/DC
Resistenza
Capacità
Frequenza
Temperatura
Test diodi
Test continuità

Campo di misura

110mV - 600V ±0.8%
110µA - 10A ±1.5%
110Ω - 40MΩ ±1.2%
11nF - 40mF ±5%
1100Hz - 110 MHz ±1.2%
-32°C - +1000°C ±3%
3V dc ±10% rdg
<30 Ω

Precisione base

- ±2% rdg
- ±2% rdg
- ±2.5% rdg
- ±10% rdg (fino a 11mF)
- ±1.5% rdg
- ±5% rdg

1740B 330

Rivettatrice di potenza compatta

Rapporto di leva ottimizzato per una maggiore compattezza e praticità d'uso
Testa regolabile per tirare il rivetto da 2 a 5 movimenti dei bracci

3,2÷6,4 mm acciaio

017400330

~~€ 67,00~~ € 38,50

3 griffe: miglior presa del rivetto



Serbatoio portasteli



1741B

Rivettatrice con 4 testine intercambiabili

- rivettatrice con 4 testine intercambiabili
- Struttura in lega leggera

017410000

~~€ 31,00~~ € 17,80



1741U

Rivettatrice ultra compatta con regolazione dello sforzo

fornita con 4 testine intercambiabili

017410450

~~€ 36,00~~ € 20,50

3 griffe: miglior presa del rivetto



L 200 mm

1749AC

Pistola ad alta spinta per ancoranti chimici e cartucce standard

017490005

~~€ 30,00~~ € 17,50



1750 500

Compressori a leva per grasso, 500 cc

017500500

~~€ 33,00~~ € 19,00



1750TA

Novità

Testina per ingrassaggio a 6 spilli ad alta pressione

- Agevole disconnessione anche con testina in pressione
- Filetto M10x1: adatto a tutti i tipi di ingrassatore: elettrico, pneumatico, manuale, ecc.
- Nessuna deformazione fino a 550 bar

017500111

~~€ 35,00~~ € 20,00

Autobloccante

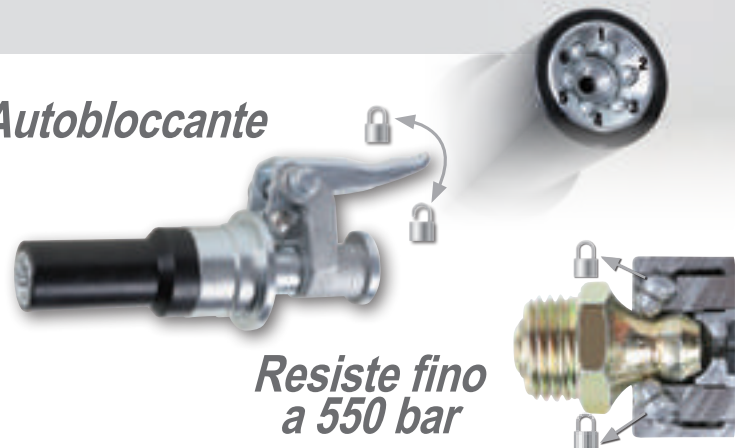

Siringhe per olio in polipropilene

- Temperatura di funzionamento: +0 - +50°C
- Non adatta per carburanti

1756C

017560502

~~€ 27,00~~ € 15,50

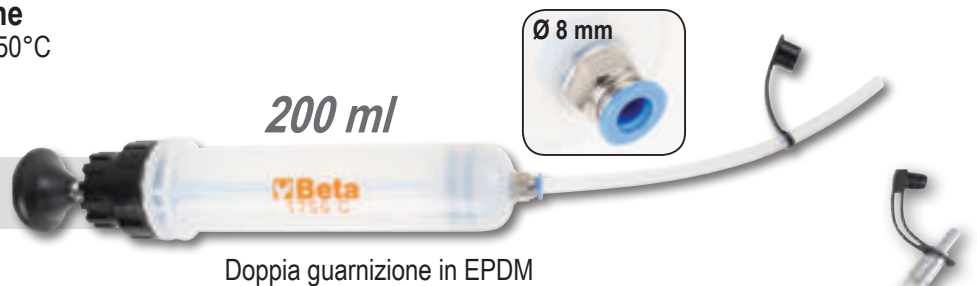

1756D

017560515

~~€ 61,00~~ € 35,00

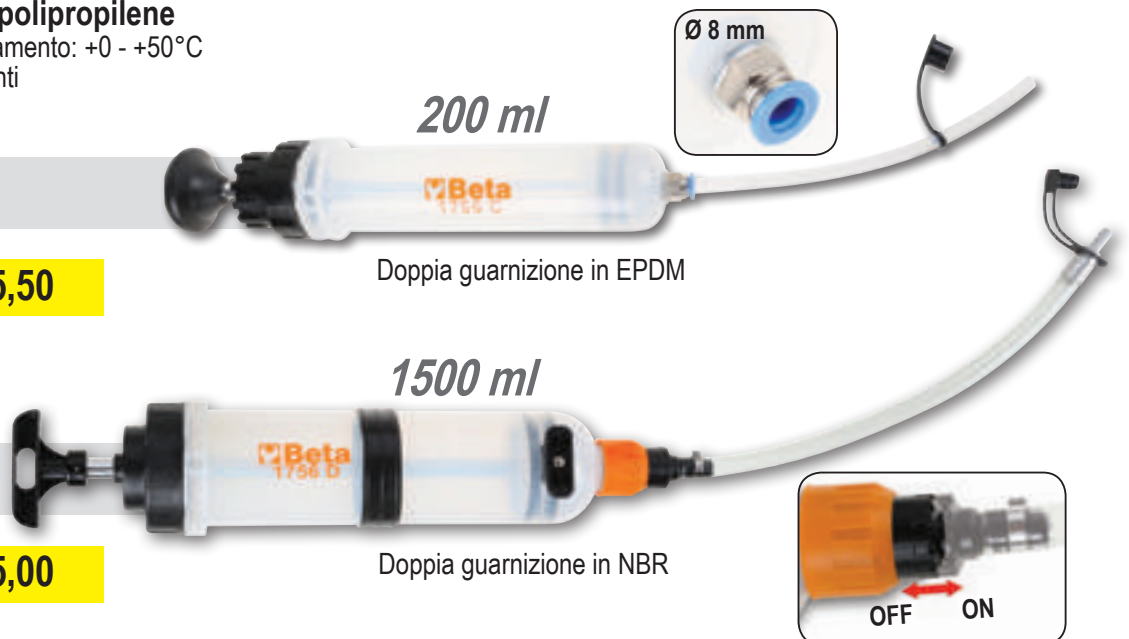

Aspiratori

Caratteristiche tecniche:

1870 1871M 1872L

tensione:	230/240 V	230/240 V	230/240 V
frequenza:	50/60 Hz	50/60 Hz	50/60 Hz
potenza Max:	1200 W	1200 W	1100 W
portata d'aria:	58 l/sec.	60 l/sec.	55 l/sec.
depressione Max:	190 mbar	220 mbar	220 mbar
capienza Max bidone:	20 l	35 l	35 l
emissioni acustiche:	<70 dB(A)	<68 dB(A)	<68 dB(A)
lunghezza cavo:	5 m	7 m	6 m

Accessori in dotazione \varnothing 36 mm:

1870 1871M 1872L

tubo corrugato:	✓	✓	✓
tubi rigidi:	✓	✓	✓
spazzola multiuso:	✓	✓	✓
bocchetta a lancia:	✓	✓	✓
raccordo di gomma \varnothing int.:	x	26 mm	x
SISTEMI FILTRANTI			
cartuccia filtro aria:	✓	✓	✓
filtro anti-schiuma:	✓	✓	✓
sacco:	x	✓	✓

Manutenzione Generale

1870 Ruote antitraccia

Aspiratore 20 litri per solidi e liquidi



018700020

~~€ 174,00~~

€ 99,00

Classe certificata M

1871M

Aspiratore 35 litri per solidi e liquidi con prese di servizio corrente ed aria compressa

Classe certificata L

1872L

Aspiratore 35 litri per solidi e liquidi

Novità



- pulizia automatica del filtro
- potenza Max presa di servizio 2000 W
- pressione Max attacco utensile pneumatico 15 bar

Novità



018710035

~~€ 1.080,00~~

€ 625,00



018720135

~~€ 380,00~~

€ 218,00

7042LCD



Maschera LCD ad oscuramento automatico, per saldatura ad elettrodo, MIG/MAG, TIG e plasma. Alimentazione a celle solari e batterie al litio per una durata eccezionale del filtro LCD

070420001

€ 147,00 € 85,00



- Area di visuale 98x43 mm
- Tonalità di oscuramento DIN 9-13 con regolazione esterna
 - Protezione UV/IR
- Tempo d'oscuramento 1/25000 s (ansi Z87.1)
- Tempo di rischiaramento 0.25-1s
 - Sensibilità e ritardo dell'oscuramento regolabili
- Accensione e spegnimento automatici
 - Funzione di smerigliatura
- Forma ottimizzata per agevolare la respirazione a schermo abbassato

Novità



Saldatrici ad inverter con uscita corrente continua (DC) per saldature ad elettrodo MMA e TIG su acciaio. Compatte e facili da trasportare funzioni arc force, hotstart, anti-sticking, protezione termostatica

270 mm
370 mm
160 mm

1860 160A

018600006

€ 710,00 € 398,00



200 mm
370 mm
130 mm

1860 140A 1860 160A

Corrente di regolazione:	5÷140A	5÷160A
Alimentazione:	1x230V	1x230V
Fattore di utilizzo :	25% - 140 A 60% - 100 A 100% - 90 A	30% - 160 A 60% - 130 A 100% - 110 A
Fusibile ritardato:	16 A	25A
Protezione:	IP23S	IP23S
Usò con generatori:	✓	✓
Cavo:	16 mm ²	25 mm ²

1860 140A

018600004

€ 590,00 € 338,00



1852R1750

Riscaldatore ad induzione portatile

- Riscalda e sblocca bulloni, dadi, mozzi e cuscinetti particolarmente bloccati senza l'utilizzo di fiamme
- Permette di scaldare qualsiasi tipo di metallo ferromagnetico

Dati tecnici:

- Tensione di ingresso: 230V AC, 50/60 Hz
- Corrente di ingresso: max. 7,5A
- Potenza: max. 1.75 kW

VANTAGGI

- 1 Risparmio di tempo: riscaldamento veloce e con grande precisione
- 2 Sicurezza anti incendio: non genera fiamme, massima sicurezza per l'operatore
- 3 Praticità: utilizzabile con una sola mano e serpentine facilmente intercambiabili



CAMPI DI APPLICAZIONE

- Automotive
- Manutenzione industriale
- Industria aeronautica
- Industria navale
- Industria petrolchimica

Dotazione:

- Due serpentine frontali con diametro 19 e 26 mm per sblocco dadi ①
- Una serpentina piatta per scaldare le superfici ③
- Una serpentina flessibile lunga 800 mm ②
- Valigetta di plastica

massima sicurezza senza l'uso di fiamme



480x370x130 mm

018520175

€ 1.160,00 € 665,00

finitura opaca

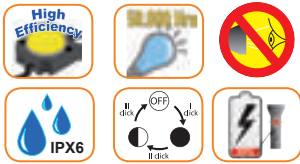

1350 LUMEN
1834P XL
 018340330
~~€ 74,00~~ € 42,50
 3xD Not included

500 LUMEN
1834P L
 018340325
~~€ 59,00~~ € 34,00
 1xAA 2xAA 3xAA Not included

350 LUMEN
1834P M
 018340320
~~€ 36,00~~ € 20,50
 1xAAA 2xAAA 3xAAA Not included

300 LUMEN
1834P S
 018340310
~~€ 29,50~~ € 17,00
 2xAA Not included

Torcia LED ad alta luminosità in robusto alluminio anodizzato

120 LUMEN



1836A

Lampada da testa a LED, con doppia luminosità e sensore ON/OFF contactless



- 120/65 lumen
- IP54
- pile: 3xAAA include

018360050
~~€ 40,50~~ € 23,50



1837N



Lampada magnetica snodata con LED ad alta luminosità fino a 400 Lumen

- Batterie (non incluse):
- 1xAA (durata 25/69 h)
- 2xAA (durata 33/96 h)
- 3xAA (durata 43/124 h)
- Lumen: 400>40>OFF
- Indicatore di carica
- Cono luminoso regolabile
- IPX6

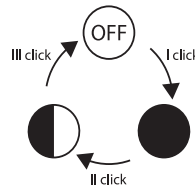
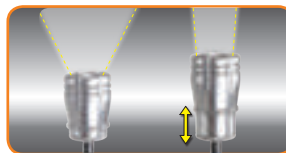

018370002
~~€ 64,00~~ € 37,00

1838COB



Lampada ricaricabile compatta con LED ad altissima luminosità.

- Batteria ai polimeri di litio
- Corpo compatto in gomma antiscivolo
- Gancio orientabile
- Base magnetica orientabile a 180 gradi
- Con caricatore 100-240Vac / 50-60Hz
- 55 / 125 lumen
- Autonomia: 5 / 2.5 ore
- IP 65

018380010

€ 71,00

€ 41,00



1838SLR



Novità

Lampada a LED snodata ricaricabile

- LED compatto frontale (200 lumen) e in testa per ispezioni (100 lumen)
- Corpo illuminante di soli 9 mm di spessore
- Autonomia di 5/2.5 ore (in base al livello di luce impostato)
- Con caricatore USB
- Con gancio metallico e magneti
- IP 30



*Sottilissima
compatta
e versatile*



018380201

€ 82,00

€ 49,00



1838FLASH



Faretto ricaricabile ultracompatto, studiato per offrire la migliore soluzione possibile in ogni utilizzo

- LED ad altissima luminosità
- IP 65
- Robusto ed affidabile
- Batteria ai polimeri di litio 7,4 V 4000 mAh



*Illuminazione
abbondante
e sempre pronta:*

con una capacità illuminante massima di 720 Lumen e con la possibilità di lavorare a batteria o a cavo è sempre pronta all'uso



018380300

€ 259,00

€ 149,00



1838/11LED

Lampada ricaricabile con LED ad altissima luminosità batteria ai polimeri di litio

- Corpo compatto in gomma antiscivolo
- Con stazione di ricarica 110-230Vac/50-60Hz



<20%

018380111

€ 126,00

€ 72,00



LED in testa per illuminazione multi direzionale

Vetrino frontale facilmente sostituibile

Gancio orientabile



illuminazione



1842LED/ABM

Lampada con LED ad altissima luminosità, 12-24 V; AC-DC

- Corpo compatto in gomma antiscivolo
- Vetrino frontale facilmente sostituibile
- Gancio orientabile
- Con LED in testa per illuminazione multidirezionale
- Cavo da 10 m



018420311

€ 98,00

€ 56,00



1846LED/BM

Avvolgitore automatico completo di lampada a LED, 100-240 Vac

- Con trasformatore di sicurezza 230/24V Max. 60 W
- Cavo da 15 m

IP42



018460301

€ 315,00

€ 179,00



IP65

1848



Avvolgitore automatico con presa Schuko

- Max 1600 W a cavo svolto
- Max 1200 W a cavo avvolto
- Cavo in gomma antischiumamento H07 - 3x1.5 mm² - 15m
- con protezione termica

018480015

€ 284,00

€ 160,00



H07

12V

Disponibili da Marzo

Novi

Trapano avvitatore ultracompatto 12V

1972/12

- Ultracompatto: 176 mm
- ultraleggero: 1,1 kg
- perfettamente bilanciato



1-10 mm

Beta 3-YEAR WARRANTY

- Doppia velocità con ingranaggi in acciaio e frizione a 18 posizioni
- Coppia fino a 34 Nm e 1500 giri/min (350 giri/min in 1° marcia),
- Impugnatura ergonomica antiscivolo
- LED frontale



Ideale per lavorare in spazi ristretti

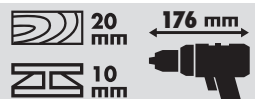

019720012

€ 359,00 € 199,00

1,1 kg

- Batterie da 2Ah con indicatore di carica sul corpo macchina
- Tripla autoprotezione della batteria (termica, sovraccarico e gestione dell'eventuale disparità di carica fra le celle)
- Forniti in valigetta rigida con 2 batterie agli ioni di litio da 2 Ah e caricatore rapido (45 min)

Avvitatore reversibile ad impulsi 12V

1982/12EF

- coppia elevata: 115 Nm
- elevata velocità: 0-2000 giri/min

1/4"



Beta 3-YEAR WARRANTY

- Attacco esagonale da 1/4" con ghiera di bloccaggio
- Ultracompatto: solo 163 mm di lunghezza
- Ultraleggero: solo 1,1 kg con batteria
- Triplo LED di illuminazione frontale
- IPM: 0÷3000



019820012

€ 369,00 € 210,00

1,1 kg

ta

Avvitatore reversibile ad impulsi 18V Brushless

Beta 3-YEAR WARRANTY

18V

1984/18QM

- Triplo LED di illuminazione frontale
- 4 modalità selezionabili:
 - 1: 270Nm; 1400 RPM
 - 2: 360Nm; 2000 RPM
 - 3: 450Nm; 2750 RPM
- A: Autostop- fino a che l'avvitatore rileva una rotazione libera applica il massimo della coppia/velocità (450Nm; 2750 RPM). Quando il bullone arriva a fine corsa e non ruota più, l'avvitatore continua ad applicare il massimo della coppia per 1 secondo poi si arresta
- IPM 0÷3500

1 1/2"



270 Nm
360 Nm
450 Nm
Autostop

2,3 kg

019840018

€ 1.040,00 € 590,00

BRUSHLESS

Motore digitale brushless senza spazzole: maggiore potenza, minori consumi di energia.

- Batterie da 5Ah con indicatore di carica
- Tripla autoprotezione della batteria (termica, sovraccarico e monitoraggio dell'eventuale disparità di carica fra le celle)
- Forniti in valigetta rigida con adattatore portainseri esagonale da 1/4" (1984/18MQ), 2 batterie agli ioni di litio da 5 Ah e caricatore rapido (80 min)

Trapano avvitatore a percussione 18V Brushless

1972/18

- Mandrino da 13 mm in acciaio
- Coppia fino a 75 Nm e 2100 giri/min (550 giri/min in 1° marcia)
- Doppia velocità con ingranaggi in acciaio e selettore per le funzioni di foratura, foratura con percussione e avvitamento con frizione a 20 posizioni
- LED di illuminazione frontale
- Impugnatura laterale in dotazione

2-13 mm



Beta 3-YEAR WARRANTY

Scatola ingranaggi interamente metallica per migliorare robustezza e durata



019720018

€ 892,00 € 510,00

2,2 kg





Sonda Ø 5,5 mm
con camera frontale
e laterale con 4 led

961D



Videoscopio digitale elettronico con sonda da 5,5 mm

Permette di visualizzare, fotografare e registrare singole immagini e filmati direttamente sullo strumento

Distanza ottimale di visualizzazione	2,5-30 cm
Alimentazione:	3,7V - 4200 mAh
Autonomia stimata	2,5-4 ore
Peso	520g
Risoluzione sensore	640x480 pixels (digitale) IP23S
Ampiezza di visualizzazione	60 gradi
Risoluzione di video e foto	640x480
Dimensioni	184x144x27 mm

009610500

€ 1.395,00 € 775,00



Ingresso micro-SD Card



Microfono



Micro USB



Micro HDMI

961D/CF3,8

Sonda da 1 metro con camera frontale da 3,8 mm

009610511

€ 590,00 € 335,00



961D/DC8,5

Sonda da 1 metro con doppia camera UV

009610513

€ 510,00 € 295,00



Caricabatterie elettronici



IP65

- Permettono la carica e il mantenimento di tutti i tipi di batterie
- Ciclo di ricarica multifase automatico
- Protezione contro: inversione di polarità e corto circuito

Novità

1498/2A

1498/4A

1498/8A

Tensione di alimentazione:	220V-240V	220V-240V	220V-240V
Frequenza:	50-60 Hz	50-60 Hz	50-60 Hz
Corrente nominale (Min-Max):	1 Amp	1-4 Amp	2-8 Amp
Tensione della batteria:	12V	6V/12V	12V
Capacità batteria:	2Ah-40Ah	4Ah-80Ah	5Ah-160Ah
Grado di protezione:	IP65	IP65	IP65
Tipo di batteria	Lithium Wet-Gel Dry-AGM	Wet-Gel Dry-AGM	Wet-Gel Dry-AGM



1498/4A



014980104

€ 124,00 € 71,00



1498/8A



014980108

€ 174,00 € 99,00



1498/2A



014980102

€ 102,00 € 58,00



Automotive

1760PA/AC-DC

Pinza amperometrica e multimetro digitale

017600000

~~€ 248,00~~ € 142,00



PARAMETRI RILEVABILI
 Tensione DC: 0.1mV ÷ 600V
 Tensione AC: 0.1mV ÷ 600V
 Corrente DC: 0.01A ÷ 1000A
 Corrente AC: 0.01A ÷ 1000A
 Resistenza: 0.1Ω ÷ 40MΩ
 Capacità: 0.001nF ÷ 40 μF
 Frequenza: 0.001kHz ÷ 4kHz
 Temperatura: -40°C ÷ 1000 °C
 -40°F ÷ 1832°F

1498/40A



 Wet, Gel Dry, Agm **IP65**

Caricabatterie avviatore multifunzione 12-24V carrellato

- processi specifici di carica WET-SPIRAL/GEL-AGM
- sistema di controllo e protezione elettronico
- funzione desolfatazione e recupero batteria
- funzione supply
- idoneo anche per batterie Start&Stop



*2 in 1
caricabatterie
+ avviatore*

Alimentazione:	230V
Tensione in uscita:	12-24V
Corrente di carica:	1-40A
Corrente di avviamento:	350A max cc
Capacità di ricarica:	4-450Ah

014980140

~~€ 940,00~~ € 545,00

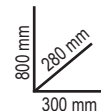

1498TB/12

Tester digitale per batteria 12V

- permette di effettuare i seguenti test: batteria, alternatore e avviamento
- software in 10 lingue
- dotato di un apposito ingresso per il collegamento di una mini stampante estraibile (accessorio opzionale 1498ST/TB))

DATI TECNICI:

- intervallo di funzionamento: 100-1700 CCA
- normative di riferimento: CCA,SAE,DIN,EN,IEC,JIS
- batterie supportate: PB, Wet, Gel, Agm, Mf, Vrla, Sli
- voltmetro: 9V-15V



370x270x100 mm

014980400

~~€ 505,00~~ € 290,00



1498TC

Tester digitale per candele

- permette un rapido e preciso test delle candele di preriscaldamento
- adatto a tutti i tipi di candele 4,4-5-7-8,5-10-11 Volt
- dotato di segnalatore acustico
- dotato di torcia a led SMD
- range di misura: 0.00÷25.0Ω"



014980450

~~€ 160,00~~ € 92,00

Solo 2,5 kg!

1498LT/12



Avviatore portatile ultraleggero ad alte prestazioni

Tensione di utilizzo	12V
Amperaggio continuo	800A
Amperaggio massimo di avviamento	2000A
Amperaggio di picco	4000A
Lunghezza cavi	500 mm
Tipo batteria	4 celle LifePo4
Funzione Salva memoria	Si
Dimensioni	260x135x72
Dotato di alimentatore di ricarica 12 V 1,3A	

4000A



Include funzione salva memoria

014980012

~~€ 665,00~~ **€ 380,00**

Avviatori portatili multifunzione



3 funzioni in 1:

- avviatore
- batteria supplementare per apparecchi elettronici (tablet, smartphone, ecc...)
- torcia led ad alta luminosità

1498CM/12



Avviatore d'emergenza portatile per motocicli



Novità

014980030

~~€ 187,00~~ **€ 105,00**

1498MN/12



Avviatore d'emergenza portatile multifunzione per auto e motocicli



014980000

~~€ 278,00~~ **€ 159,00**



1498CM/12 1498MN/12

corrente di picco:	400A	600A
uscita USB:	5V 2,1A	5V 1A-2A
dimensioni:	130x50x15 mm	190x85x35 mm
peso:	300 g	542 g
uscita per avviamento:	12 Volt	12 Volt



Dotazione:

- cavo di avviamento con pinze isolate e diodo di protezione
- caricabatteria da rete
- caricabatteria da auto
- cavo USB con adattatori di carica

240x185x60 mm

Avviatori per auto, veicoli commerciali e truck

	1498/24	1498C/24
Amperaggio di picco:	4200 A (12 V) 2100 A (24 V)	4000A (24V)
Tensione di utilizzo:	12-24 V	24V
Tipo di batteria:	AGM	AGM
Lunghezza cavi:	160 cm	200 cm
Tensione di ricarica:	230V	230V
Peso:	17 kg	50 kg



1498/24



12V-24V



014980490

€ 1.110,00 € 635,00



1498C/24



Pb Wet, Gel Dry, Agm IP65

- Carrellato
- prestazioni molto elevate per numerosi avviamenti anche particolarmente impegnativi

24V



950 mm
460 mm
230 mm

014980244

€ 3.250,00 € 1.880,00



CX49

Novità

Carrello multifunzione, vuoto
Utilizzabile come postazione mobile per strumenti di diagnosi, laptop, tester e caricabatterie.

- Struttura in lamiera verniciata: massima stabilità e solidità
- Maniglia ergonomica
- 2 ruote posteriori fisse Ø 160 mm
- 2 ruote anteriori girevoli Ø 125 mm (una con freno)

2 ripiani centrali con posizione regolabile e 1 ripiano basso fisso



Piano di appoggio superiore su 2 livelli

Cassetto estraibile per mini tastiera

4 utili avvolgicavo laterali in plastica

1 portacarta

2 pratici contenitori laterali



36 kg

1099 mm
460 mm
435 mm

049000102

€ 540,00 € 310,00

Novità

1464APB

Set per la verifica dell'impianto alta pressione benzina dei motori FSI, da utilizzare con 1464T

Include sensore da 200 bar e raccordi di collegamento

014640500

~~€ 308,00~~ € 177,00

240x210x50 mm



1464T

Tester digitale per la misurazione di pressione e compressione



014640050

~~€ 695,00~~ € 398,00

1464TDI

Set per la verifica della pressione della pompa nei motori TDI da utilizzare con 1464T

Include raccordo di collegamento

014640600

~~€ 95,00~~ € 56,00

240x210x50 mm



1464AP

Set per la verifica dell'impianto alta pressione dei motori diesel common rail, con 1464T

- set tubi alta pressione
- raccordi di collegamento
- sensore da 2.000 bar

014640450

~~€ 625,00~~ € 359,00

430x310x50 mm



960AD/TP2

Set di adattatori per 1464T e 960TP

- finti iniettori
- finte candele
- adattatori candela
- adattatori tappi olio
- raccordi iniezione benzina
- set guarnizioni di ricambio

430x310x50 mm

009600510

~~€ 410,00~~ € 235,00



Nuovi set per il tester multifunzione

CARATTERISTICHE

- display touch screen da 5"
- batteria ai polimeri di lito ricaricabile
- completo di sensore da 80 bar (basse pressioni) e cavo USB



Novità

1464PT

Set per la verifica dell'impianto alta pressione benzina dei motori FSI, da utilizzare con 1464T

Include sensore e cavo di collegamento

014640550

€ 134,00

€ 79,00

240x210x50 mm



1464PF

Novità

Set per la verifica della pressione nell'impianto frenante da utilizzare con 1464T

Include adattatori, sensori e raccordi

014640650

€ 555,00

€ 319,00

600x280x60 mm



1464IC

Set di finti iniettori e finte candele per 1464T

Permette di collegarsi al motore per la verifica della compressione nei motori diesel con tester digitale 1464T.

- n° 22 false candele
- n° 5 falsi iniettori
- n° 1 kit falso iniettore universale per truck, motori marini e macchine agricole

014640350

€ 460,00

€ 265,00

559x312x50 mm



1759HD/3

Strumenti per controllo tenuta impianto di raffreddamento e riempimento circuito

Permette di verificare sotto pressione le perdite del circuito (tubi, giunti, pompe, radiatori) e riempire velocemente il circuito evitando la formazione di bolle d'aria.

017590063

~~€ 458,00~~ € 265,00

600x500x140 mm



1472FCA

Novità

Pinza per rimozione fascette con cremagliera tipo Visa®

014720041

~~€ 49,00~~ € 28,00



Facile apertura del blocco senza rischio di danneggiamenti

1472H

Semplice e veloce

Attrezzo per rimozione fascette Henn

Novità

014720000

~~€ 19,00~~ € 11,00



1497CEL

Novità

Utensile per la rimozione dei connettori elettrici del gruppo VAG

Permette di scollegare rapidamente i connettori senza danneggiarli

014970170

~~€ 16,00~~ € 9,30



960KPC **14"**

Estrattore reversibile ad impulsi con coppia regolabile per candele di preriscaldamento

- l'estrattore pneumatico a coppia regolabile e le bussole speciali consentono di svitare le candele bloccate riducendo al minimo il rischio di danneggiamento
- 5 bussole da 1/4" macchina lunghe, speciali per candele: 8-9-10-11-12 mm, 2 prolunghe e 1 snodo
- 4 coppie di serraggio regolabili: 10-20-30-40 Nm
- regolazione destrorsa e sinistrorsa

009600780

~~€ 254,00~~ € 148,00



420x185x60 mm

Evita la rottura delle candele durante lo smontaggio

960KC/M....

Assortimento di utensili per la rimozione delle candele di preriscaldamento spezzate o danneggiate

Per candele con filetto M8-M9-M10

009600801

~~€ 335,00~~ € 193,00



380x290x50 mm

960EPC

Set di utensili per l'estrazione dell'elettrodo delle candele di preriscaldamento

- permette una corretta e rapida estrazione della parte terminale dell'elettrodo in caso di rottura o grippaggio all'interno della sede della candela.
- adatto per candele con filettatura: M8x1 - M9x1 - M10x1 - M10x1,25



ZONA DI ROTTURA

009600790

~~€ 499,00~~ € 290,00



270x230x80 mm

960UC

Set di utensili per estrazione candele bloccate con punta deformata M8-M9-M10

- Permette la presa rapida direttamente sull'esagono delle candele
- Dotato di innovativo sistema "fast lock" che garantisce la massima rapidità
- Non danneggia la testata motore e garantisce un lavoro professionale
- Estrazione a colpi tramite massa battente in dotazione



Ideale per candele bloccate e deformate



275x250x50 mm

009600900

~~€ 395,00~~

€ 227,00

1462KI

Assortimento di utensili per estrazione iniettori Diesel Common Rail Permette la rimozione degli iniettori DELPHI-BOSCH-SIEMENS-DENSO

- funzionamento meccanico e idraulico
- include un martinetto idraulico da 12 tonnellate
- può essere utilizzato direttamente sul veicolo con motore montato
- le numerose possibilità di regolazione sulla testata permettono di lavorare sulla maggior parte dei motori in circolazione



014620235

~~€ 1.990,00~~ **€ 1.150,00**

590x470x140 mm

960RPI

Attrezzo soffiatore per pulizia sede iniettori

Per motori con candele M8x1 - M9x1 - M10x1 - M10x1.25

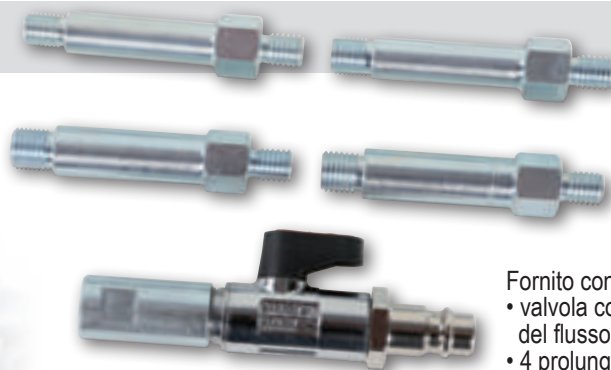

- Fornito con:
- valvola con leva per l'interruzione del flusso dell'aria
 - 4 prolunghie per sede candele

009600940

~~€ 150,00~~

€ 89,00

Novità

1462CF/C6



Agevole accesso
al dado di fissaggio
della connessione
carburante

Automotive

Serie di 6 chiavi poligonali aperte
per raccordi carburante iniettori

Misure incluse nella serie:
12-14-16-17-18-19 mm



014620006

€ 75,00

€ 44,00

260x145x60 mm

960PI/S



Kit per pulizia sedi iniettori
Incluso nel kit:

- 3 spazzole in acciaio Ø 18, 22, 25 mm per pulizia sedi iniettori
- 2 spazzole Ø 14 e 16 mm per pulizia fondo sedi iniettori
- 6 tappi per occlusione foro collegamento camera di combustione
- 1 scovolino per pulizia foro collegamento camera di combustione
- 1 portainseri flessibile con impugnatura



009600214

€ 122,00

€ 71,00

Impugnatura porta-accessori
flessibile per tutte le angolazioni

1895 6

Novità

Vasca di lavaggio ad ultrasuoni da 6 litri

- attraverso il riscaldamento del liquido e con l'azione degli ultrasuoni permette di pulire efficacemente parti di ricambio e pezzi metallici in genere (iniettori, carburatori, valvole, ecc...)
- display digitale con regolazione della temperatura e del tempo di lavaggio
- per una pulizia più accurata aggiungere soluzioni detergenti non schiumogene specifiche per vasche ad ultrasuoni
- la funzione degassificazione accelera la liberazione d'aria in tutto il volume della vasca aumentando l'efficacia degli ultrasuoni



Ideale
per iniettori

Capacità vasca:	6 litri
Potenza di riscaldamento:	300 Watt
Regolazione temperatura:	0÷80°C
Regolazione tempo di lavaggio:	minuti 0-99
Frequenza:	40 kHz
Alimentazione:	220/230V

018950060

€ 560,00

€ 325,00



Novità

1485BP

Attrezzo a mezzaluna per bloccare le pulegge dentate

Regolabile tramite manico girevole, stringe e blocca la puleggia dall'esterno, evitando danni ai sensori circostanti

014850000

~~€ 175,00~~ € 99,00



1485VAG/K2

Novità

Coppia di attrezzi per precaricare i cuscinetti della cinghia di distribuzione

Coppia di attrezzi per precaricare i cuscinetti della cinghia di distribuzione

- Testa orientabile in 3 posizioni
- 1 attrezzo con testa profonda 12,5 mm
- 1 attrezzo con testa profonda 21,5 mm

014850080

~~€ 59,00~~ € 34,00



1485MJ

Novità

Attrezzo per bloccare l'albero a camme dei motori 1.3 16V Multijet

2 teste con 3 profili per operare su tutti i motori 1.3 16V Multijet montati da gruppo FCA, Opel, Ford e Suzuki

014850150

~~€ 99,00~~ € 58,00



Indispensabile per operare con i perni di fase inseriti

1529/C7

Novità

Estrattore per pulegge

Incluse nel kit:

- 2 griffe con doppio piede spesso 4,7 mm
- 2 griffe a singolo piede spesso 4,3 mm
- 1 griffa con doppio piede spesso 2,3 mm
- 1 griffa a singolo piede spesso 2,3 mm

La coppia di griffe è componibile in base all'esigenza operativa

015290100

~~€ 119,00~~ € 68,00



285x155x50 mm

Novità

Automotive

1548/C8

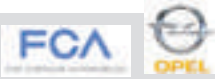

Estrattore di cuscinetti interni del cambio gruppo FCA e Opel

Comprende 2 coppie di griffe e 4 differenti supporti per adattarsi ai differenti modelli a partire dal 2007

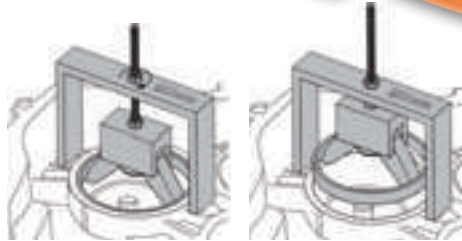

420x180x60 mm

015480800

~~€ 449,00~~ € 258,00

1884

Atrezzo per l'inserimento di olio nei cambi manuali, automatici e nei differenziali

Completo di 12 adattatori per la connessione diretta
• dotato di valvola di non-ritorno per un'efficace azione di inserimento dell'olio senza perdite
• portata: 70 cc a pompata
• capacità serbatoio: 7,5 litri
• massima viscosità olio utilizzabile: SAE 140



12 ADATTATORI

FORD	AT-101
UNIVERSAL (Bmw, Honda, Nissan...)	AT-102
VW-AUDI	AT-103
VW-AUDI-PORSCHE	AT-104
VW-AUDI-MINI COOPER	AT-105
MERCEDES	AT-106
DSG	AT-107
VW-AUDI CVT	AT-108
VOLVO	AT-109
TOYOTA-LEXUS	AT-110
SKODA	AT-111
VW Passat/Tiguan <2007	AT-112

018840010

~~€ 380,00~~ € 219,00

1493DSG

Novità

Chiave per smontaggio/montaggio filtro olio cambio DSG



014930800

~~€ 29,00~~ € 17,00

1438DSG

Leva per bloccaggio/sbloccaggio cambio DSG a doppia frizione del gruppo VAG

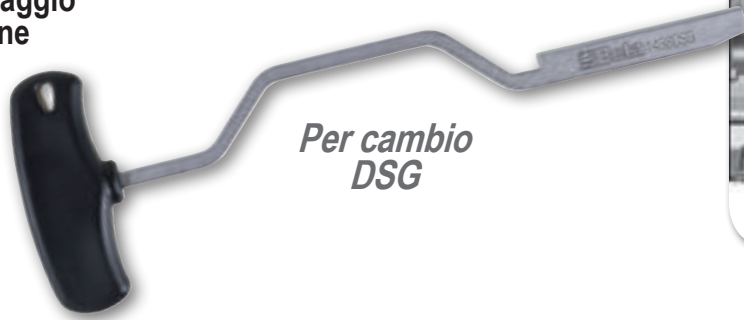
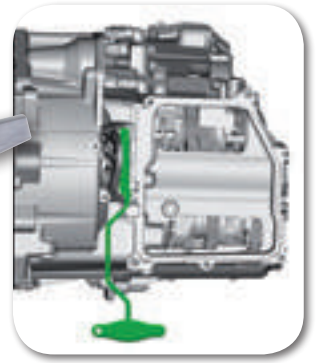

Per cambio DSG

014380200

~~€ 24,00~~ € 14,00

1482

Chiave regolabile autoserrante per ghiere galleggianti serbatoio



Ø mm 89+170



014820001

~~€ 88,00~~ € 51,50

1493FT

12"



Chiave per filtri gasolio Ford Transit

Utilizzabile su tutte le versioni Transit, Transit Custom e Tourneo Custom dal 2012



014930085

~~€ 19,50~~ € 11,50

1493B/S5

38"

Serie di 5 chiavi poligonali per cartucce filtri olio di difficile accesso

Misure incluse nella serie: 24-27-32-36-38 mm

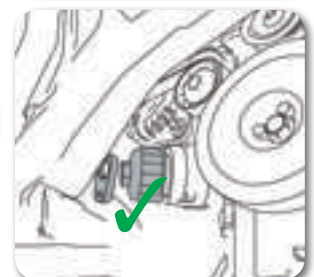
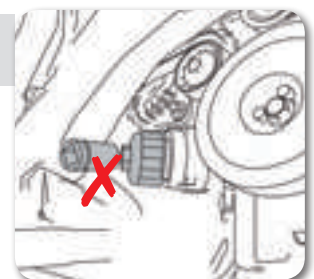
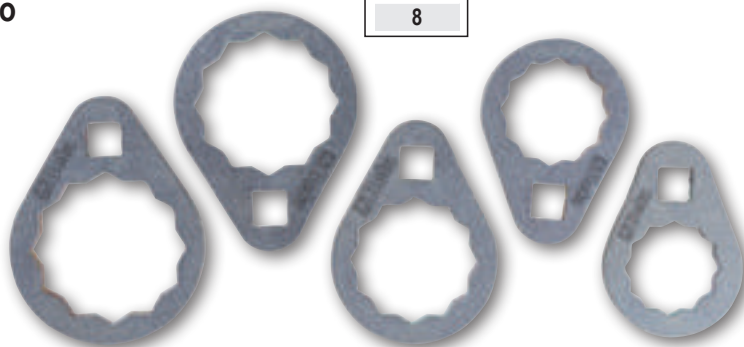
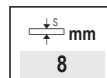

014930599

~~€ 63,00~~ € 37,00



Recuperatori olio

- indicatore di livello
- coppa di grande diametro con griglia scolafiltro capacità 12l
- svuotamento pneumatico del serbatoio con tubo da 1,8 m
- vaschetta portautensili

1877

Recuperatore olio esausto
carrellato
con serbatoio da 90 litri



018770008

€ 575,00 € 328,00

Automotive

1877A

Recuperatore/aspiratore
olio esausto, carrellato
con serbatoio da 90 litri
e precamera

- precamera trasparente capacità 9,5 l
- tubo aspirazione da 1,8 m
- N° 6 sonde in dotazione



018770080

€ 998,00 € 573,00

1758LG

Numerose possibilità di utilizzo

Lamina modellabile in alluminio
rivestita in gomma, per la
canalizzazione dei liquidi

L	H
mm	mm
365	168



017580006

€ 36,00 € 21,00



Novità

1466/C5



Kit 5 chiavi per spurgo freni

Inclusi nel kit:

- 5 chiavi misura 7-8-9-10-11 mm
- 1 tubo di scarico con valvola di non ritorno

*Non serve rimuovere
la chiave per
effettuare lo spurgo*

*L'olio passa all'interno
della bussola*



014660100

€ 99,00 € 58,00

260x170x50 mm

1471M/C22

Utensile pneumatico per arretrare e ruotare i pistoncini dei freni a disco destrorsi e sinistrorsi con accessori

- martinetto automatico
- 150 kg di spinta
- pressione di utilizzo 5÷8 bar

014710101

~~€ 240,00~~ € 138,00

350x310x85 mm



1569/A

Assortimento di utensili per l'estrazione e l'introduzione dei silent block ponte posteriore, paraoli albero motore e cuscinetti ruota

- le boccole possono essere utilizzate sia direttamente sul veicolo che alla pressa idraulica
- estrazione diretta con chiave
- facilità di utilizzo, non servono macchine pneumatiche o idrauliche

- il kit comprende:
4 barre filettate: M10-M12-M14-M16
4 rondelle
boccole per diametri da 44 a 82 mm

015690011

~~€ 820,00~~ € 470,00

530x415x115 mm

Diametri da 44 a 82 mm



1569/B

Novità

Assortimento utensili per l'estrazione e l'introduzione di silent block, paraoli e cuscinetti ruota

- estrazione diretta con chiave
- facilità d'uso, non servono utensili pneumatici o idraulici
- può essere utilizzato in abbinamento al kit Beta 1569/A

- Il kit include:
• barre filettate, rondelle e boccole per diametri da 14 a 32 mm

015690015

~~€ 643,00~~ € 370,00

530x415x115 mm

Diametri da 14 a 32 mm



1569CP/50

A min÷Max 9,5÷50 mm L 130 mm

015690750

~~€ 104,00~~ € 60,00

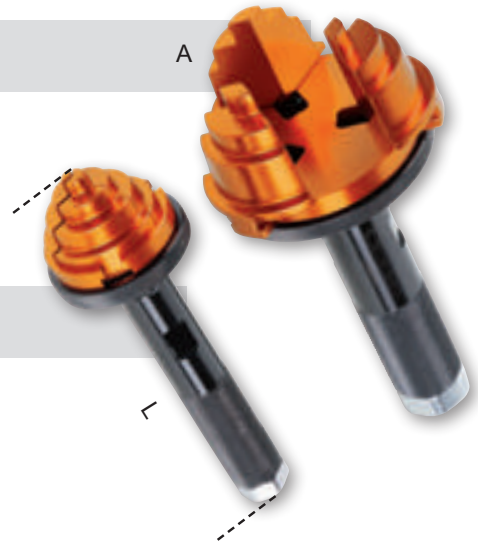

1569CP/90

A min÷Max 18÷90 mm L 145 mm

015690790

~~€ 130,00~~ € 75,00

1530/C5

Kit per estrazione mozzi e cuscinetti ruote a 3,4,5 fori

Il kit comprende:

- 1 flangia universale 96÷138 mm
- 1 vite idraulica da 12 tonnellate
- 1 massa battente da 2,8 kg indispensabile per mozzetti senza bullone di fissaggio centrale

015300300

~~€ 435,00~~ € 250,00



1558/C4



Novità

Attrezzo per anelli seeger interni ed esterni con azionamento a vite

Grazie all'attacco quadro si applica una forza elevata in entrambe le condizioni d'utilizzo

015580100

~~€ 128,00~~ € 75,00



Puntali in dotazione: Ø 2,5-3-3,5 mm

984

Novità

Pinza per le coperture plastiche dei dadi ruota

L mm	H mm
195	4



009840005

~~€ 19,50~~ € 11,50



1567

Leva per estrazione testine braccio oscillante e ammortizzatori dal montante

Un solo operatore riesce senza sforzo a posizionare la leva e a procedere al disassemblaggio

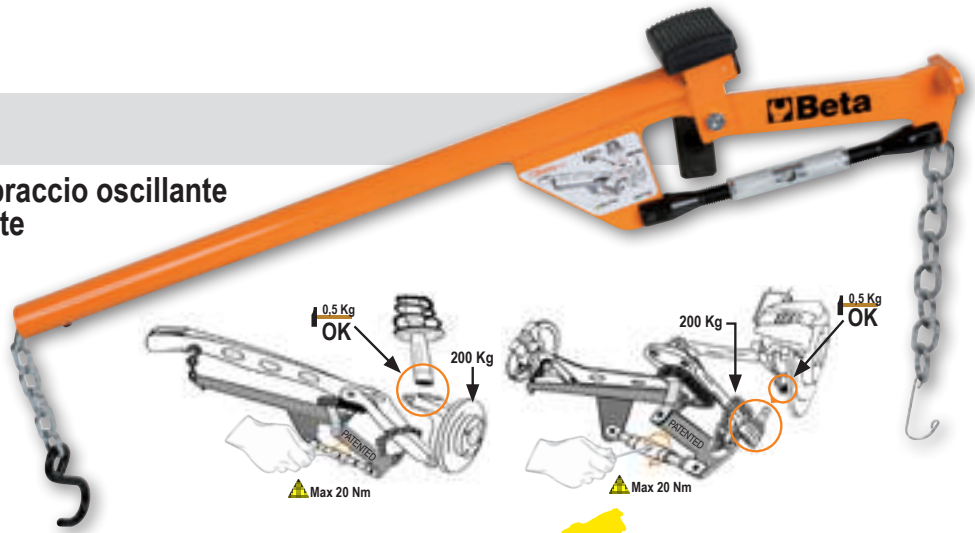

015670001

~~€ 260,00~~ € 150,00

3035

Carrello trasporta pneumatici

- per trasportare agevolmente pneumatici fino ad un massimo di 980 mm di diametro
- utilizzabile come piano d'appoggio, grazie al blocco della posizione in orizzontale
- 2 ruote Ø 260 mm e 2 ruote Ø 125 mm
- altezza massima trasportabile 1,60 m
- portata massima 200 kg
- forche regolabili in 2 posizioni: 880 e 980 mm

030350100

~~€ 790,00~~ € 455,00



Novità

1767A

Asta telescopica

- ideata per sostenere cofani e portelloni con pistoni scarichi
- utilizzabile per mantenere i pedali bloccati



017670000

~~€ 54,00~~ € 31,00

720LC/C3



3 chiavi a bussola Macchina con inserti polimerici per dadi ruote

in valigetta di plastica
 Ø: 17 - 19 - 21 mm

007200653

~~€ 30,00~~ € 17,00



148x132x44 mm

spinta massima 2 ton (10 bar)



1550U

Smonta ammortizzatori pneumatico per autoveicoli, SUV e veicoli commerciali

- SISTEMA UNIVERSALE DI PRESA SUPERIORE
- SISTEMA DI SICUREZZA ATTIVA SULLA MOLLA
- GRIGLIA DI PROTEZIONE "FULL BODY"

Fornito di 2 staffe inferiori per diametri 78-205 mm

DATI TECNICI

Potenza spinta:

2 ton (10 bar) - 1.6 ton (8 bar) - 1.2 ton (6 bar)

Corsa di compressione molla: 335 mm

015500010

~~€ 2.345,00~~ € 1.325,00

1550U/SS187

Staffa sinistrorsa per 1550U particolarmente indicata per molle con profilo sinistro tipo Nissan Qashqai e Renault Koleos
Diametro 105-187 mm



015500018

~~€ 298,00~~ € 172,00

1550U/M

Morsa per smonta ammortizzatori 1550U permette il bloccaggio dello stelo dell'ammortizzatore



015500021

~~€ 280,00~~ € 162,00

1457/B4

Novità

Serie di attrezzi per lo sbloccaggio dei connettori Rilsan

Misure incluse:

- 6x8
- 10x12
- 15x16
- 18x1/2



014570024

~~€ 38,00~~ € 22,00

1365/K13

Pompa oleodinamica 10 t e kit accessori per carrozzeria in pratica valigia trolley

Inclusi nel kit:

- pompa oleodinamica 10T e pistone
- pinza divarica parafanghi e piastra di appoggio
- base a "L", punzoni e prolunghe
- raccordo maschio maschio per montaggio accessori

013650013

~~€ 530,00~~ € 299,00

900x420x180 mm



1368

Kit ripara plastiche

DESCRIZIONE TECNICA

- lunghezza cavo pistola termica 3,5 m
- 2 regolazioni di potenza 35-75 W
- pistola termica con terminali in ottone a 2 angolazioni di inserimento graffetta: 0°-90°
- protezione output: fusibile 10 A
- fornito senza graffette

013680001

~~€ 330,00~~ € 191,00



Permette di riparare velocemente crepe e rotture di parti in plastica

1368G/K400

Assortimento di 400 graffette per 1368

In dotazione:

- 100 graffette a serpentina piccola
- 100 graffette a serpentina grande
- 100 graffette per angoli concavi
- 100 graffette per angoli convessi

013680140

~~€ 54,00~~ € 31,00



1366/K5

Tirabolli pneumatico a massa battente da 1,1 kg

Inclusi nel kit:

- 1 ventosa Ø 75 mm
- 1 ventosa Ø 100 mm
- 1 ventosa Ø 125 mm
- 1 gancio

Ventose a forte tenuta

013660010

~~€ 180,00~~ € 103,00

610x240x90 mm



1360/K6

Novità

Martello in alluminio con testa tonda piana, puntali di plastica intercambiabili e bulino

Fornito con:

- 4 puntali di plastica
- 1 bulino regolabile in 2 differenti lunghezze applicabile al martello

013600006

~~€ 68,00~~ € 40,00

Ø 34 mm

L 320 mm



1366A

Novità

Attrezzo levabolli con kit di 19 funghetti di plastica

Da utilizzare con colla a caldo per superfici verniciate, 1851VK-12V.

Ideale per:

- bolli da grandine
- ammaccature causate da portiera
- piccole ammaccature in genere

013660200

~~€ 69,00~~ € 40,00

1366/KF

Kit di 19 funghetti di plastica per attrezzi levabolli

013660205

~~€ 25,00~~ € 14,50



1478/3P

Novità

Pinza per pioli in plastica con 3 punti di sblocco

014780151

~~€ 51,00~~ € 29,50

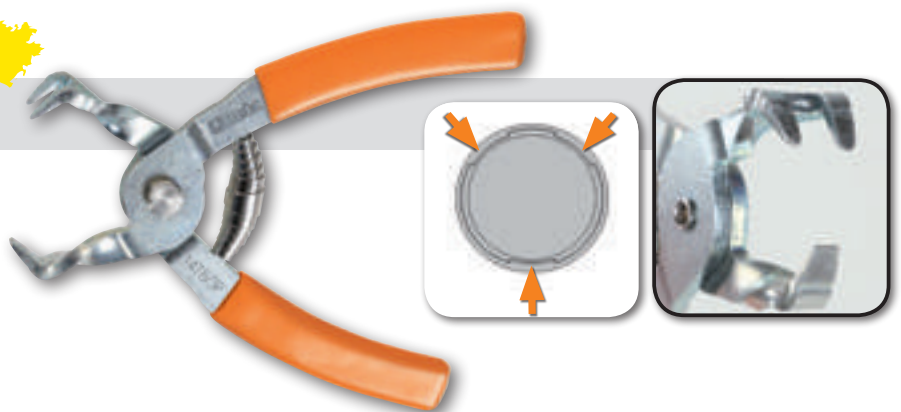

1479L/S2

Novità

Coppia di leverini multifunzione in Teflon®

014790510

~~€ 29,00~~ € 17,00

Molteplici impieghi con solo due utensili



Alta resistenza allo sforzo

1344

Novità

Coppia di spessimetri per carrozzieri a 10 lame con ventosa di fissaggio

013440010

~~€ 29,00~~ € 17,00

Indicati per:

- posizionamento lunotti
- mantenimenti della posizione durante i montaggi



1362

Novità

Piastra di riscontro bolli applicabile con ventosa

Permette di rilevare anche le più piccole imperfezioni della carrozzeria

LxH
mm
240x200

013620010

~~€ 63,00~~ € 36,00



1367/S6

Novità

Serie di fustelle per l'installazione dei sensori di parcheggio

Misure incluse nella serie:
Ø 17 - 18 - 19 - 20 - 21 - 22 mm

Fori perpendicolari e senza sbavature

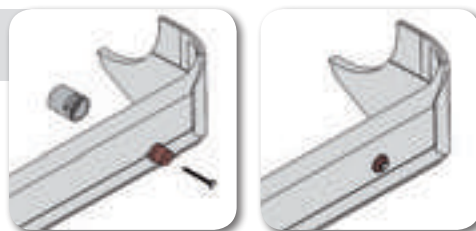

013670100

~~€ 194,00~~ € 113,00



1498PC 12-24 V

Stabilizzatore di tensione 12-24 V

Indispensabile per proteggere le centraline in fase di saldatura ed avviamenti con avviatori

014980801

~~€ 78,00~~ € 45,00



2250-0

Novità

Seggiolino girevole con vassoio

- Seduta tonda girevole
- Altezza regolabile tramite pistone a gas (410÷530 mm)
- 5 ruote pivotanti

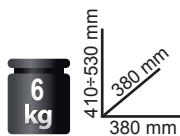

022500011

~~€ 80,00~~

€ 46,00



2 portaminuterie/portautensili di cui uno regolabile in altezza

Per lavorare comodamente con ogni cosa a portata di mano

3000M/LT

Lettino sottomacchina

- Rivestimento in PVC con imbottitura in gomma piuma per un elevato comfort



Regolazione del cuscino tramite pistone a molla progressiva

030000220

~~€ 135,00~~

€ 75,00



3003

Lettino sottomacchina in plastica antiurto

Ø ruote: 76 mm

030030001

~~€ 67,50~~

€ 39,00



120 mm

2254T

Novità

Tappeto per protezione ginocchia
Realizzato in EVA antiscivolo



022540047

~~€ 21,50~~ € 12,50

290 mm
30 mm
470 mm

3009

Carrello per movimentazione veicoli

Portata massima: 550 kg

- 4 rulli basculanti
- larghezza rulli 200 mm
- per ruote fino a 240 mm di larghezza



RUOTE IN VULKOLLAN CON CUSCINETTO



Ideale per:

- recupero vetture incidentate su carro attrezzi
- autofficine e carrozzerie
- movimentazione auto all'interno di show room

030090001

~~€ 340,00~~ € 195,00

3007

Carrello sottoscocca per veicoli senza meccanica anteriore/posteriore

Permette di movimentare agevolmente i veicoli privi di avantreno o retrotreno durante le fasi di lavorazione

- 4 ruote pivotanti, di cui 2 con freno, adatte all'uso in forno di verniciatura
- 2 supporti scorrevoli per adattarsi a tutti i telai
- portata massima 800 kg

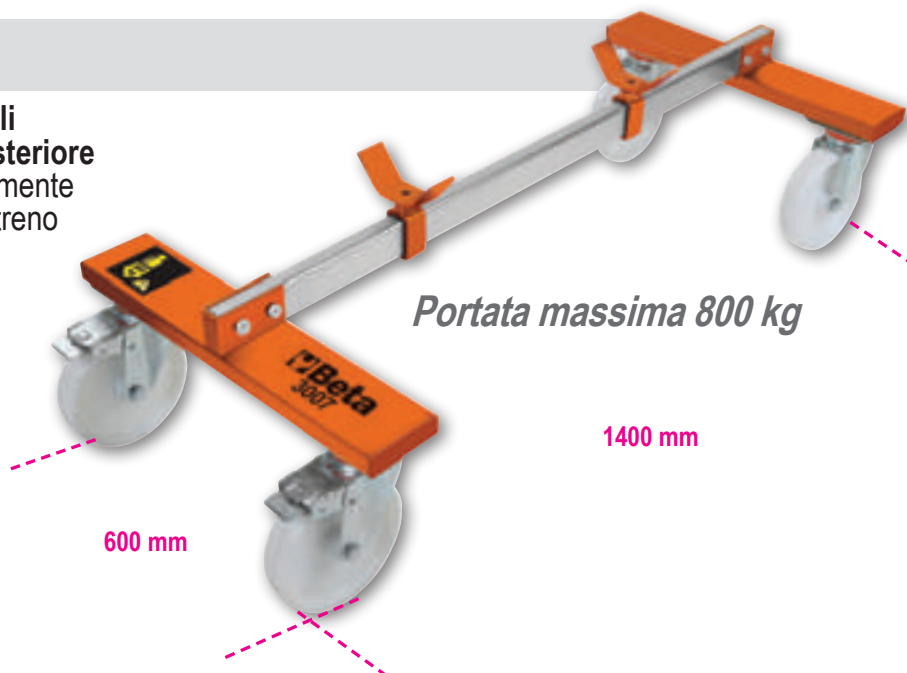





Portata massima 800 kg

1400 mm

600 mm

030070001

~~€ 445,00~~ € 256,00

	3030/2T	3065/40-20T	3067/70-13T
Portata:	2 t	40 - 20 t	70 - 43 - 23 - 13 t
Alzata min./Max:	85 - 520 mm	150 - 300 mm	150 - 400 mm
Valvole di discesa controllata:	✓	✓	✓
Peso:	45 kg	39 kg	74 kg
Indicato per:	 		



3030/2T

Sollevatore idraulico a 6 ruote

- ottima manovrabilità del sollevatore su pavimentazioni sconnesse e irregolari
- doppie ruote anteriori basculanti in materiale plastico (PTFE)
- il pedale permette un rapido avvicinamento

A	1000 mm
B	85 mm
C	520 mm
D	2 t

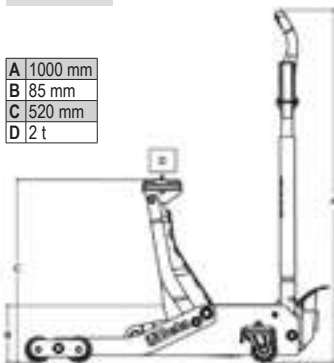

030300020

€ 628,00 € 355,00

3065/40-20T

Sollevatore oleopneumatico 40-20 t

A	1400 mm
B	1320 mm
C	525 mm
D	270 mm
E	150 mm
F	78 mm
G	72 mm
H	150 mm
K	206 mm
L	300 mm
M	20 t
N	40 t

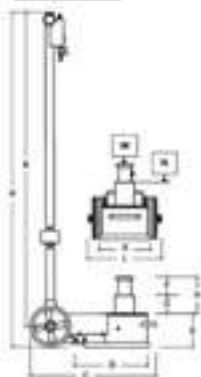

030650200

€ 2.390,00 € 1.360,00

3067/70-13T

Sollevatore oleopneumatico 70-43-23-13 t

A	1430 mm
B	1320 mm
C	1000 mm
D	320 mm
E	150 mm
F	250 mm
G	60 mm
H	68 mm
L	56 mm
M	66 mm
N	350 mm
O	240 mm
P	70 t
Q	43 t
R	23 t
S	13 t

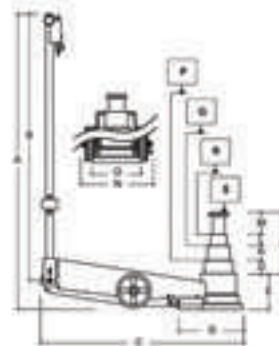

030670130

€ 4.490,00 € 2.560,00

Presse idrauliche con pistone mobile

	3027 20	3027 30	3027 50
Capacità massima:	20 t	30 t	50 t
Pompa manuale a 2 velocità:	✓	✓	✓
Pistone mobile:	✓	✓	✓
Sicurezza idraulica in caso di sovraccarico:	✓	✓	✓
Manometro:	✓	✓	✓
Serie prismi a V inclusi:	✓	✓	✓
Argano:	x	x	✓



140 kg

3027 20

030270020

€ 1.865,00 € 1.070,00

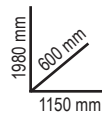

230 kg

3027 30

030270030

€ 3.250,00 € 1.870,00

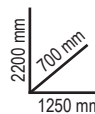

350 kg

3027 50

030270050

€ 4.450,00 € 2.570,00

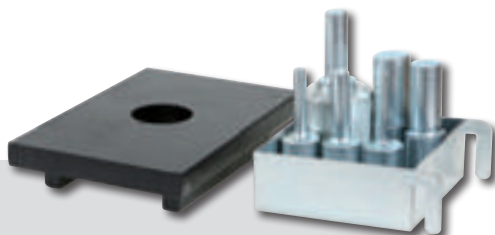

Serie di cacciaspine e piastra per pressa
 ø cacciaspine: 5-10-14-18-24-29 mm

	Pressa		€
3027/KP20	3027 20	030270520	€ 400,00 € 230,00
3027/KP30	3027 30	030270530	€ 400,00 € 230,00
3027/KP50	3027 50	030270550	€ 470,00 € 270,00

3027/KPP50

Comando a pedale per pressa idraulica 3027 20-30-50



030270555

€ 195,00 € 112,00

3025

Grù idraulica pieghevole con pompa a doppio effetto

- Portata massima 1 t
- la struttura richiudibile riduce al minimo gli ingombri
- 4 posizioni di carico: 450-650-800-1000 kg
- velocità di discesa controllata



030250001

~~€ 1.530,00~~ € 880,00



3025/PF

Pinza
movimentazione fusti

Portata
massima
300 kg



030250011

~~€ 248,00~~ € 142,00

Sollevatori idraulici da fossa e sottoponte

3026 0,3 3026 0,5 3026 1,0

Portata massima:	300 kg	500 kg	1000 kg
Pompa a pedale:	✓	✓	✓
Altezza min/Max:	1120 - 1970 mm	1140 - 1990 mm	1140 - 1990 mm
Valvola limitatrice di carico:	✓	✓	✓

3026/SP

Supporto universale
per trasmissioni

- Permette ad un solo operatore di smontare e rimontare le trasmissioni di autovetture, veicoli commerciali e fuoristrada con rapidità e sicurezza.
- Adatto per steli con diametro: 25-30-35-45 mm
- Portata massima: 150 kg



3026 0,3

030260003

~~€ 565,00~~ € 325,00

3026 0,5

030260005

~~€ 665,00~~ € 385,00

3026 1,0

030260010

~~€ 815,00~~ € 465,00



030260505

~~€ 555,00~~ € 320,00



1927P

Avvitatore reversibile in materiale composito

- Meccanismo impulsivo doppio martello
- Leggero e bilanciato per un facile utilizzo
- Comando d'inversione a leva
- Tre differenti livelli di potenza in avvitamento
- Scarico dell'aria attraverso l'impugnatura
- Impugnatura antivibrazioni



1/2"

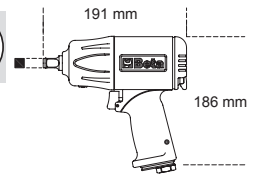

Velocità libera	giri/min	7.500
Massa battente		Doppio martello
Coppia massima	Nm	1750
Capacità vite/dado	Cl 8.8	M24 ● 36 mm
Capacità vite/dado	Cl 12.9	M20 ● 30 mm
Attacco aria	GAS	1/4"
Pressione di utilizzo	bar	6,2
Ø tubo consigliato	mm	10
Consumo aria medio	l/min	290
Peso	kg	2

Super potente
1750 Nm

019270008

€ 410,00 € 237,00



1927XM/K5

Avvitatore reversibile compatto fornito con 5 bussole Macchina, in valigetta di plastica

- Meccanismo impulsivo singolo martello
- Incredibilmente compatto e potente
- Comando d'inversione a pulsante azionabile con una sola mano
- Tre differenti livelli di potenza in avvitamento
- Scarico dell'aria attraverso l'impugnatura
- Gancio per bilanciatore



1/2"

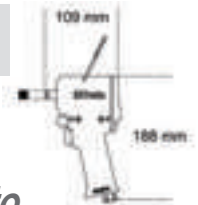

Super compatto
770 Nm

Velocità libera	giri/min	10.000
Massa battente		Singolo martello
Coppia massima	Nm	770
Capacità vite/dado	Cl 8.8	M22 ● 34 mm
Capacità vite/dado	Cl 12.9	M18 ● 27 mm
Attacco aria	GAS	1/4"
Pressione di utilizzo	bar	6,2
Ø tubo consigliato	mm	10
Consumo aria medio	l/min	122
Peso	kg	1,3

720 17-19-21-22-24 mm

019270129

307x206x86 mm

€ 280,00 € 161,00



1927CD/K3

Avvitatore reversibile, in materiale composito fornito con 3 bussole Macchina, in valigetta di plastica

- Meccanismo impulsivo doppio martello
- Leggero e bilanciato per un facile utilizzo
- Dotato di un'elevata coppia
- Comando d'inversione a leva
- Tre differenti livelli di potenza in avvitamento
- Scarico dell'aria attraverso l'impugnatura
- Silenziato



1/2"

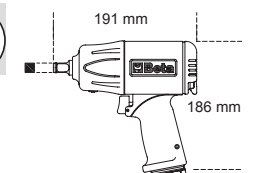

Velocità libera	giri/min	7.000
Massa battente		Doppio martello
Coppia massima	Nm	1020
Capacità vite/dado	Cl 8.8	M22 ● 34 mm
Capacità vite/dado	Cl 12.9	M18 ● 27 mm
Attacco aria	GAS	1/4"
Pressione di utilizzo	bar	6,2
Ø tubo consigliato	mm	10
Consumo aria medio	l/min	130
Peso	kg	1,9

019270107

350x305x86 mm

€ 395,00 € 205,00

720LC 17-19-21 mm

Novità

720S/SB6

1/2"



Serie di 6 chiavi a bussola Macchina compatte con attacco quadro femmina 1/2", con guida appendibile

Ø 13-15-17-19-22-24 mm

007200906

€ 43,50 € 25,00



1928K4

Avvitatore reversibile fornito con 4 bussole Macchina serie lunga, in valigetta di plastica

- Meccanismo multiplo "Pin Clutch"
- Tre differenti livelli di potenza in avvitamento e svitamento
- Impugnatura antiscivolo
- Comando d'inversione a leva
- Scarico dell'aria attraverso l'impugnatura

728L 27-30-32-36 mm

019280104

~~€ 670,00~~ € 385,00



3/4"

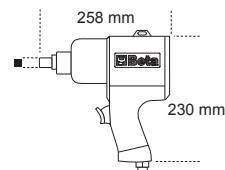

410x330x106 mm

Velocità libera	giri/min	4.000
Massa battente		Pin Clutch
Coppia massima	Nm	1.493
Capacità vite/dado	Cl 8.8	M27●41 mm
Capacità vite/dado	Cl 12.9	M24●36 mm
Attacco aria	GAS	3/8"
Pressione di utilizzo	bar	6,2
Ø tubo consigliato	mm	10
Consumo aria medio	l/min	260
Peso	kg	5,2



1928DA

Avvitatore reversibile

- Meccanismo impulsivo doppio martello
- Robusto e compatto, dotato di un'elevata coppia
- Comando d'inversione a leva
- Tre differenti livelli di potenza in avvitamento e svitamento
- Scarico dell'aria attraverso l'impugnatura
- Impugnatura ergonomica antiscivolo

019280022

~~€ 655,00~~ € 378,00



3/4"

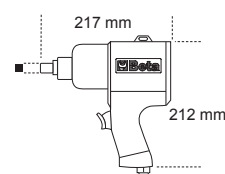

Velocità libera	giri/min	5.000
Massa battente		Doppio martello
Coppia massima	Nm	1.695
Capacità vite/dado	Cl 8.8	M27●41 mm
Capacità vite/dado	Cl 12.9	M24●36 mm
Attacco aria	GAS	3/8"
Pressione di utilizzo	bar	6,2
Ø tubo consigliato	mm	10
Consumo aria medio	l/min	210
Peso	kg	4,3



1928CD

Avvitatore reversibile in materiale composito

- Meccanismo impulsivo doppio martello
- Elevato rapporto peso/potenza
- Comando d'inversione a leva
- Tre differenti livelli di potenza in avvitamento
- Scarico dell'aria attraverso l'impugnatura
- Silenziato

019280007

~~€ 840,00~~ € 485,00



3/4"

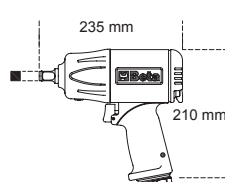

Velocità libera	giri/min	4.500
Massa battente		Doppio martello
Coppia massima	Nm	1.800
Capacità vite/dado	Cl 8.8	M27●41 mm
Capacità vite/dado	Cl 12.9	M24●36 mm
Attacco aria	GAS	3/8"
Pressione di utilizzo	bar	6,2
Ø tubo consigliato	mm	10
Consumo aria medio	l/min	215
Peso	kg	3,5



1930PA

1"

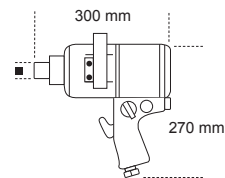

Avvitatore reversibile

- Estremamente compatto
- Dotato di maniglia ausiliaria
- Comando d'inversione a leva
- Tre differenti livelli di potenza in avvitamento e svitamento
- Scarico dell'aria attraverso l'impugnatura

019300032

€ 980,00 € 565,00

Velocità libera	giri/min	3.500
Massa battente		Doppio martello
Coppia massima	Nm	2445
Capacità vite/dado	Cl 8.8	M36●55mm
Capacità vite/dado	Cl 12.9	M30●46mm
Attacco aria	GAS	1/2"
Pressione di utilizzo	bar	6,2
Ø interno tubo aria	mm	13
Consumo aria medio	l/min	350
Peso	kg	9,6



1930HLA

1"



Avvitatore reversibile

- Dotato di maniglia ausiliaria
- Comando d'inversione a leva
- Quattro differenti livelli di potenza in avvitamento e svitamento
- Scarico dell'aria posto nella parte superiore del corpo

019300040

€ 1.440,00 € 830,00

Velocità libera	giri/min	3.000
Massa battente		Doppio martello
Coppia massima	Nm	3661
Capacità vite/dado	Cl 8.8	M42●65mm
Capacità vite/dado	Cl 12.9	M33●50mm
Attacco aria	GAS	1/2"
Pressione di utilizzo	bar	6,2
Ø interno tubo aria	mm	13
Consumo aria medio	l/min	460
Peso	kg	16,4

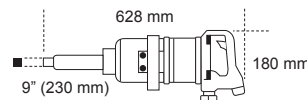

1930ZL

1 1/2"



Avvitatore reversibile

- Dotato di maniglia ausiliaria
- Comando d'inversione a leva
- Quattro differenti livelli di potenza in avvitamento e svitamento
- Scarico dell'aria posto nella parte superiore del corpo

019300070

€ 1.820,00 € 1.050,00

Velocità libera	giri/min	3.000
Massa battente		Doppio martello
Coppia massima	Nm	4.068
Capacità vite/dado	Cl 8.8	M42●65 mm
Capacità vite/dado	Cl 12.9	M36●55 mm
Attacco aria	GAS	1/2"
Pressione di utilizzo	bar	6,2
Ø interno tubo aria	mm	13
Consumo aria medio	l/min	480
Peso	kg	15

Alta coppia 4068 Nm

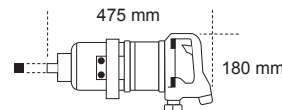

19211

12"



Cricchetto reversibile a coppia elevata

- Coppia di reazione notevolmente ridotta
- Impugnatura ergonomica in gomma
- Scarico posteriore dell'aria

019210035

€ 278,00 € 160,00

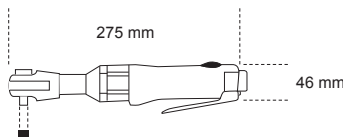

Velocità libera	giri/min	400
Massa battente		Pin Clutch
Coppia massima	Nm	101
Capacità vite/dado	Cl 8.8	M10●16mm
Capacità vite/dado	Cl 12.9	M8●13mm
Attacco aria	GAS	1/4"
Pressione di utilizzo	bar	6,2
Ø interno tubo aria	mm	10
Consumo aria medio	l/min	235
Peso	kg	1,3



1937RT

Novità

Levigatrice orbitale palmare in composito, con aspirazione

- Fornita con due platorelli di levigatura; rettangolare (100x110 mm) e a Delta (125x95 mm)
- Dotata di piastra velcrata
- Estremamente compatta e maneggevole
- Diametro orbita 5 mm
- Regolazione in continuo della velocità del motore
- Impugnatura in morbido materiale antiscivolo
- Predisposta per la connessione a sistemi di aspirazione con raccordo girevole
- Scarico dell'aria orientabile

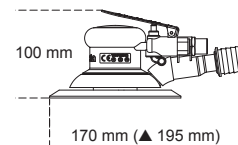

Velocità libera	giri/min	10.000
Attacco aria	GAS	1/4"
Pressione di utilizzo	bar	6,2
Ø interno tubo aria	mm	10
Consumo aria medio	l/min	180
Peso	kg	0,9

019370021

~~€ 385,00~~ € 222,00

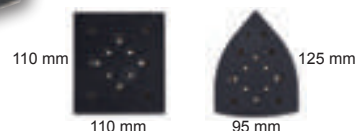

1937

Levigatrice rotorbitale palmare senza lubrificazione in composito

- Non necessita di lubrificazione
- Estremamente compatta e maneggevole
- Diametro orbita 5 mm
- Platorello con velcro a 6 fori
- Regolazione in continuo della velocità del motore
- Impugnatura in morbido materiale antiscivolo
- Predisposta per la connessione a sistemi di aspirazione con raccordo girevole
- Scarico dell'aria orientabile

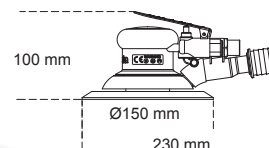

Velocità libera	giri/min	12.000
Potenza	kW	0,18
Dimensione platorello	mm	150
Filettatura albero		5/16"-24
Attacco aria	GAS	1/4"
Pressione di utilizzo	bar	6,2
Ø interno tubo aria	mm	10
Consumo aria medio	l/min	170
Peso	g	860

019370001

~~€ 368,00~~ € 212,00



1937KC

Novità

Mini levigatrice rotorbitale

- Diametro orbita 4 mm
- Fornita con due platorelli di levigatura da Ø 50 mm e Ø 75 mm
- Assortimento di 10 dischi, per ciascuna misura, di carta abrasiva con grana 400, 600, 800
- Impugnatura a pistola
- Regolatore di potenza
- Regolatore di portata in ottone*
- Adatta per le operazioni di finitura in spazi ristretti

Compatta e leggera: 640 g



280x280x90 mm



Velocità libera	giri/min	15000
Potenza	kW	0,25
Dimensione platorello	mm	50 - 75
Filettatura albero		M6 x 1,0
Attacco aria	GAS	1/4"
Pressione utilizzo	bar	6,2
Ø interno tubo aria	mm	10
Consumo aria medio	l/min	79
Peso kit	kg	1,4

019370171

~~€ 205,00~~ € 118,00

1933I

Smerigliatrice assiale

- Indicata per lavori gravosi e prolungati grazie all'elevata potenza
- Corpo ed impugnatura in materiale antiscivolo
- Montata su cuscinetti a sfera
- Regolatore di velocità mediante manopola
- Attacco aria girevole
- Scarico dell'aria posteriore silenziato
- Leva di sicurezza a scatto
- Fornita con pinza da 3 e 6 mm

019330005

~~€ 124,00~~ € 71,00

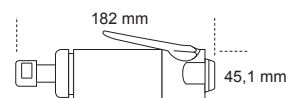

Velocità libera	giri/min	20.000
Capacità pinza	mm	3-6
Potenza	kW	0,38
Attacco aria	GAS	1/4"
Pressione di utilizzo	bar	6,2
Ø interno tubo aria	mm	10
Consumo aria medio	l/min	260
Peso	g	670

1940E10

Martello scalpellatore

- Compatibile con scalpelli con attacco esagonale da 10 mm
- Permette di tagliare lamiere, viti e carrozzerie, rimuovere punti di saldatura, rivetti, intonaci e piastrelle
- Fornito con molla di ritegno e trattenitore di sicurezza a baionetta
- Controllo preciso della velocità tramite pulsante
- Impugnatura ergonomica e antiscivolamento per il miglior equilibrio
- Scarico dell'aria attraverso l'impugnatura
- Dispositivo di riduzione dell'urto

019400010

~~€ 170,00~~ € 98,00

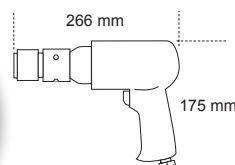

Colpi al minuto		2900
Dimensione attacco	mm	10
Dimensione pistone	mm	19
Corsa pistone	mm	67
Attacco aria	GAS	1/4"
Pressione di utilizzo	bar	6,2
Ø interno tubo aria	mm	10
Consumo aria medio	l/min	76
Peso	kg	1,7

1942A

Seghetto alternativo

- Potente e maneggevole
- Ideale per tagliare carrozzerie, scarichi e marmitte, alluminio e plastica
- Dotato di impugnatura in gomma, tubo di scarico in PVC e tubo di alimentazione raccordato
- Scarico dell'aria posteriore

019420000

~~€ 256,00~~ € 148,00

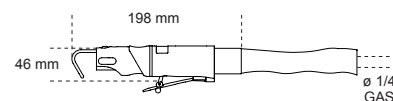
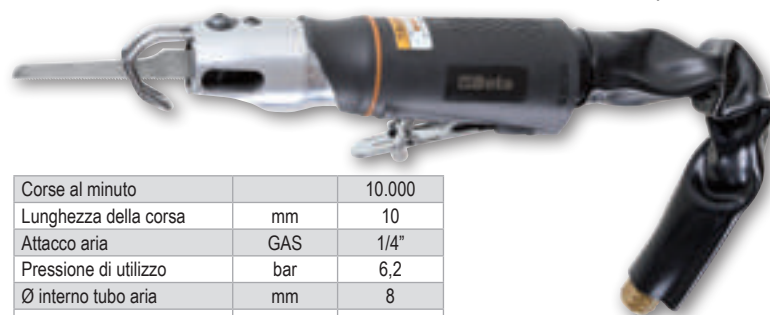

Corse al minuto		10.000
Lunghezza della corsa	mm	10
Attacco aria	GAS	1/4"
Pressione di utilizzo	bar	6,2
Ø interno tubo aria	mm	8
Consumo aria medio	l/min	75
Peso	g	550

1949GPE

Pistola per gonfiaggio pneumatici

- Pressione di esercizio: 0÷11 bar (0÷160 psi)
- Funzione di scarico pressione
- Funzione di sola misurazione della pressione
- Manometro rivestito in gomma antiurto
- Rotazione del tubo a 360°

019490008

~~€ 105,00~~ € 60,00

640 g

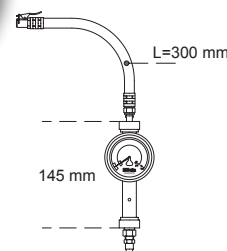

Utensili Pneumatici

1946C4,8 

Rivettatrice con aspirazione automatica

- Per impiego con rivetti in acciaio, acciaio inox, alluminio e rame, da 2,4 - 3,2 - 4,0 - 4,8 mm
- Becco conico a punta
- Potente e maneggevole, con impugnatura in composito
- Completa di serbatoio portasteli



Materiale/rivetto	2,4	3,2	4	4,8
Rame	✓	✓	✓	✓
Alluminio	✓	✓	✓	✓
Acciaio	✓	✓	✓	✓
Acciaio Inox	✓	✓	✓	✓

Potenza di trazione	N	8.900
Lunghezza della corsa	mm	15
Capacità massima rivetti	Ø acciaio inox	4,8 mm
Attacco aria	GAS	1/4"
Pressione di utilizzo	bar	6,2
Ø interno tubo aria	mm	10
Consumo aria	l/ciclo	2,6
Peso	kg	1,5

019460006

~~€ 495,00~~ € 285,00

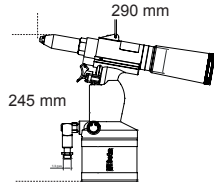

1947G 

Novità

Pistola pneumatica per ingrassaggio

- Funziona con cartucce da 400 g o grasso sfuso fino a 500 cc
- Testa pressofusa in alluminio
- Impugnatura ergonomica con figura a spigolo per accedere in spazi ristretti
- Dimensioni del tubo: 54 (interno) x 260 mm

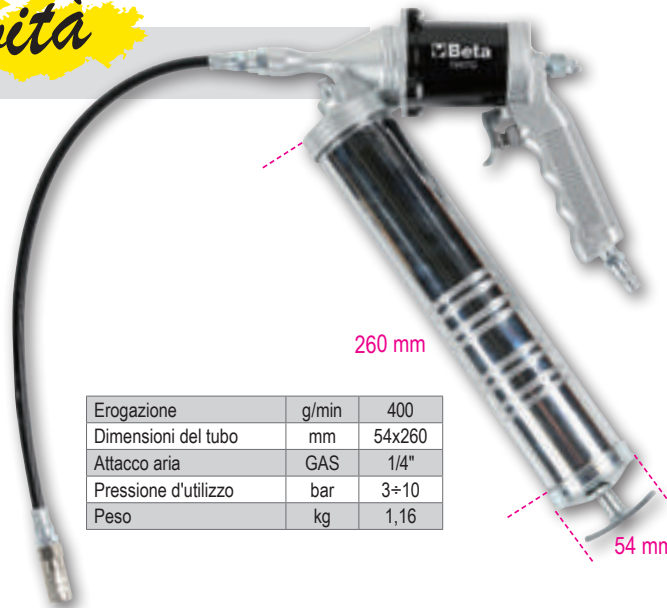

019470051

~~€ 132,00~~ € 76,00

Erogazione	g/min	400
Dimensioni del tubo	mm	54x260
Attacco aria	GAS	1/4"
Pressione d'utilizzo	bar	3÷10
Peso	kg	1,16

Avvolgitubo automatici

- Corpo in materiale plastico antiurto per aria compressa o acqua fredda
- Staffa di fissaggio metallica, orientabile
- Dispositivo automatico di arresto del tubo alla lunghezza desiderata

1901T/10 1901BM/8

Attacco aria	GAS	3/8"	1/4"
Lunghezza tubo	m	15+1	9+1
Pressione massima di utilizzo	bar	15	12
Ø interno tubo aria	mm	10	8
Materiale Tubo		PVC	Poliuretano

1901T/10



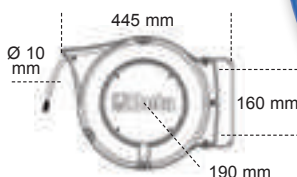

019010210

~~€ 255,00~~ € 146,00

6,5 kg

1901BM/8



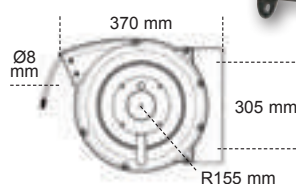

019010111

~~€ 215,00~~ € 123,00

3,5 kg

Scarpe in pelle idrorepellente con lamina antiperforazione

- Puntale in acciaio
- Lamina antiperforazione in acciaio elastico

7241C

~~€ 39,00~~ € 22,30



EU	UK	
35	2,5	072410535
36	3,5	072410536
37	4,5	072410537
38	5	072410538
39	6	072410539
40	6,5	072410540
41	7	072410541
42	8	072410542
43	9	072410543
44	10	072410544
45	10,5	072410545
46	11	072410546
47	12	072410547
48	13	072410548



BASSA

EN ISO
20345
2011

S3 SRC



7243C

~~€ 40,00~~ € 22,80



EU	UK	
35	2,5	072430335
36	3,5	072430336
37	4,5	072430337
38	5	072430338
39	6	072430339
40	6,5	072430340
41	7	072430341
42	8	072430342
43	9	072430343
44	10	072430344
45	10,5	072430345
46	11	072430346
47	12	072430347
48	13	072430348

Rapido
sfilamento



ALTA

EN ISO
20345
2011

S3 RS SRC

7246B

~~€ 39,50~~ € 22,50

Scarpe in pelle
scamosciata, traforate

- Puntale in acciaio
- Lamina antiperforazione in acciaio elastico

EU	UK	
35	2,5	072460235
36	3,5	072460236
37	4,5	072460237
38	5	072460238
39	6	072460239
40	6,5	072460240
41	7	072460241
42	8	072460242
43	9	072460243
44	10	072460244
45	10,5	072460245
46	11	072460246
47	12	072460247
48	13	072460248



EN ISO
20345
2011

S1P SRC



7245B

~~€ 46,50~~ € 26,50

Scarpe "saldatore"
stringate in pelle
idrorepellente con
rapido sfilamento
e protezione frontale
con chiusura a strappo

- Puntale in acciaio
- Lamina antiperforazione in acciaio elastico

EU	UK	
35	2,5	072450235
36	3,5	072450236
37	4,5	072450237
38	5	072450238
39	6	072450239
40	6,5	072450240
41	7	072450241
42	8	072450242
43	9	072450243
44	10	072450244
45	10,5	072450245
46	11	072450246
47	12	072450247
48	13	072450248

Rapido
sfilamento



EN ISO
20345
2011

S3 RS SRC

Calzature di sicurezza

7249G

~~€ 50,00~~

€ 28,70

Scarpe in pelle scamosciata con inserti in mesh

- Puntale in acciaio
- Lamina antiperforazione in acciaio elastico

EU	UK	
35	2,5	072490135
36	3,5	072490136
37	4,5	072490137
38	5	072490138
39	6	072490139
40	6,5	072490140
41	7	072490141
42	8	072490142
43	9	072490143
44	10	072490144
45	10,5	072490145
46	11	072490146
47	12	072490147
48	13	072490148



EN ISO 20345 2011

S1P SRC

7236B

~~€ 64,00~~

€ 37,00

Scarpe in action nabuk idrorepellente con inserti in nylon

- Puntale in acciaio
- Lamina antiperforazione in acciaio elastico

EU	UK	
35	2,5	072360235
36	3,5	072360236
37	4,5	072360237
38	5	072360238
39	6	072360239
40	6,5	072360240
41	7	072360241
42	8	072360242
43	9	072360243
44	10	072360244
45	10,5	072360245
46	11	072360246
47	12	072360247
48	13	072360248



EN ISO 20345 2011

S3 SRC

Scarpe alte in pelle scamosciata con inserti in nylon, suola in gomma ad alta resistenza e rapido sfilamento
Calzatura WR resistente all'acqua

- Puntale in composito
- Lamina antiperforazione in fibra composita

Novità

7237WR

~~€ 80,00~~

€ 46,00

Rapido sfilamento

CE
WR

EU	UK	
35	2,5	072370235
36	3,5	072370236
37	4,5	072370237
38	5	072370238
39	6	072370239
40	6,5	072370240
41	7	072370241
42	8	072370242
43	9	072370243
44	10	072370244
45	10,5	072370245
46	11	072370246
47	12	072370247
48	13	072370248



MARRONE

Suola in gomma



EN ISO 20345 2011

S3 RS WR HRO SRC
Endurance

Novità

7238WR

~~€ 80,00~~

€ 46,00

Rapido sfilamento

CE
WR

EU	UK	
35	2,5	072380235
36	3,5	072380236
37	4,5	072380237
38	5	072380238
39	6	072380239
40	6,5	072380240
41	7	072380241
42	8	072380242
43	9	072380243
44	10	072380244
45	10,5	072380245
46	11	072380246
47	12	072380247
48	13	072380248



NERO

Suola in gomma

7212FG

~~€ 58,00~~ € 33,50

Scarpe in pelle scamosciata traforata con inserto antiabrasione nella zona del puntale

- Puntale in composito
- Lamina antiperforazione in fibra composita
- Suola in poliuretano monodensità

EU	UK	
35	2,5	072120035
36	3,5	072120036
37	4,5	072120037
38	5	072120038
39	6	072120039
40	6,5	072120040
41	7	072120041
42	8	072120042
43	9	072120043
44	10	072120044
45	10,5	072120045
46	11	072120046
47	12	072120047
48	13	072120048

7213FG

~~€ 58,00~~ € 33,50

Scarpe in pelle scamosciata con inserti in mesh ad alta traspirazione

- Puntale in composito
- Lamina antiperforazione in fibra composita
- Suola in poliuretano monodensità

EU	UK	
35	2,5	072130035
36	3,5	072130036
37	4,5	072130037
38	5	072130038
39	6	072130039
40	6,5	072130040
41	7	072130041
42	8	072130042
43	9	072130043
44	10	072130044
45	10,5	072130045
46	11	072130046
47	12	072130047
48	13	072130048



EN ISO 20345 2011

S1P SRC



7214FN

~~€ 63,00~~ € 36,00

Scarpe in action nabuk idrorepellente con inserto antiabrasione nella zona del puntale

- Puntale in composito
- Lamina antiperforazione in fibra composita
- Suola in poliuretano monodensità

EU	UK	
35	2,5	072140035
36	3,5	072140036
37	4,5	072140037
38	5	072140038
39	6	072140039
40	6,5	072140040
41	7	072140041
42	8	072140042
43	9	072140043
44	10	072140044
45	10,5	072140045
46	11	072140046
47	12	072140047
48	13	072140048

7215FN

~~€ 65,00~~ € 37,50

Mocassini in action nabuk idrorepellente con inserto antiabrasione nella zona del puntale

- Puntale in composito
- Lamina antiperforazione in fibra composita
- Suola in poliuretano monodensità

EU	UK	
35	2,5	072150135
36	3,5	072150136
37	4,5	072150137
38	5	072150138
39	6	072150139
40	6,5	072150140
41	7	072150141
42	8	072150142
43	9	072150143
44	10	072150144
45	10,5	072150145
46	11	072150146
47	12	072150147
48	13	072150148



EN ISO 20345 2011

S3 SRC



Calzature di sicurezza

Scarpe in pelle pieno fiore idrorepellente con inserti in pelle scamosciata idrorepellente

- Puntale in composito
- Lamina antiperforazione in fibra composita

7200PN

~~€ 70,50~~

€ 40,50



EU	UK	
35	2,5	072000535
36	3,5	072000536
37	4,5	072000537
38	5	072000538
39	6	072000539
40	6,5	072000540
41	7	072000541
42	8	072000542
43	9	072000543
44	10	072000544
45	10,5	072000545
46	11	072000546
47	12	072000547
48	13	072000548



BASSA

EN ISO 20345 2011

S3 SRC



Imolà

7201PN

~~€ 72,50~~

€ 41,50



Rapido
sfilamento

EU	UK	
35	2,5	072010535
36	3,5	072010536
37	4,5	072010537
38	5	072010538
39	6	072010539
40	6,5	072010540
41	7	072010541
42	8	072010542
43	9	072010543
44	10	072010544
45	10,5	072010545
46	11	072010546
47	12	072010547
48	13	072010548



ALTA

EN ISO 20345 2011

S3 RS SRC

Scarpe in pelle scamosciata traforata

- Puntale in composito
- Lamina antiperforazione in fibra composita

7210PB

~~€ 66,00~~

€ 37,80

Misano



EU	UK	
35	2,5	072100435
36	3,5	072100436
37	4,5	072100437
38	5	072100438
39	6	072100439
40	6,5	072100440
41	7	072100441
42	8	072100442
43	9	072100443
44	10	072100444
45	10,5	072100445
46	11	072100446
47	12	072100447
48	13	072100448



EN ISO 20345 2011

S1P SRC

7211PG

~~€ 66,00~~

€ 37,80

Mugello



EU	UK	
35	2,5	072110435
36	3,5	072110436
37	4,5	072110437
38	5	072110438
39	6	072110439
40	6,5	072110440
41	7	072110441
42	8	072110442
43	9	072110443
44	10	072110444
45	10,5	072110445
46	11	072110446
47	12	072110447
48	13	072110448



Scarpe in pelle scamosciata con inserti in nylon mesh e PU

- Puntale in fibra di vetro
- Lamina antiperforazione in fibra composita

7313G

~~€ 77,50~~ € 44,30



EU	UK	
35	2,5	073130635
36	3,5	073130636
37	4,5	073130637
38	5	073130638
39	6	073130639
40	6,5	073130640
41	7	073130641
42	8	073130642
43	9	073130643
44	10	073130644
45	10,5	073130645
46	11	073130646
47	12	073130647
48	13	073130648



7313B

~~€ 77,50~~ € 44,30



EU	UK	
35	2,5	073130835
36	3,5	073130836
37	4,5	073130837
38	5	073130838
39	6	073130839
40	6,5	073130840
41	7	073130841
42	8	073130842
43	9	073130843
44	10	073130844
45	10,5	073130845
46	11	073130846
47	12	073130847
48	13	073130848



EN ISO 20345 2011

S1P SRC

Monza

Scarpe in pelle scamosciata idrorepellente con inserto in microfibra

- Puntale in composito
- Lamina antiperforazione in fibra composita

7316N

~~€ 88,50~~ € 50,50



EU	UK	
35	2,5	073160535
36	3,5	073160536
37	4,5	073160537
38	5	073160538
39	6	073160539
40	6,5	073160540
41	7	073160541
42	8	073160542
43	9	073160543
44	10	073160544
45	10,5	073160545
46	11	073160546
47	12	073160547
48	13	073160548



7323M

~~€ 92,50~~ € 53,00



EU	UK	
35	2,5	073230335
36	3,5	073230336
37	4,5	073230337
38	5	073230338
39	6	073230339
40	6,5	073230340
41	7	073230341
42	8	073230342
43	9	073230343
44	10	073230344
45	10,5	073230345
46	11	073230346
47	12	073230347
48	13	073230348



EN ISO 20345 2011

S3 SRC

Calzature di sicurezza

7361UB

~~€ 88,50~~ € 50,80

Scarpe basse in pelle scamosciata traforata con inserti in tessuto canvas traspirante

- Puntale in composito
- Lamina antiperforazione in fibra composita

EU	UK	
35	2,5	073610235
36	3,5	073610236
37	4,5	073610237
38	5	073610238
39	6	073610239
40	6,5	073610240
41	7	073610241
42	8	073610242
43	9	073610243
44	10	073610244
45	10,5	073610245
46	11	073610246
47	12	073610247
48	13	073610248



EN ISO 20345 2011

S1P SRC **Kyalami**



7360UN

~~€ 92,50~~ € 53,40

Scarpe basse in pelle scamosciata idrorepellente

- Puntale in composito
- Lamina antiperforazione in fibra composita

EU	UK	
35	2,5	073600335
36	3,5	073600336
37	4,5	073600337
38	5	073600338
39	6	073600339
40	6,5	073600340
41	7	073600341
42	8	073600342
43	9	073600343
44	10	073600344
45	10,5	073600345
46	11	073600346
47	12	073600347
48	13	073600348



EN ISO 20345 2011

S3 SRC **Pergusa**

Scarpe alte in pelle scamosciata idrorepellente
Collare in morbido tessuto con imbottitura paramalleolo

- Puntale in composito
- Lamina antiperforazione in fibra composita

7368UN

~~€ 97,00~~ € 55,80

Monaco 

EU	UK	
35	2,5	073680335
36	3,5	073680336
37	4,5	073680337
38	5	073680338
39	6	073680339
40	6,5	073680340
41	7	073680341
42	8	073680342
43	9	073680343
44	10	073680344
45	10,5	073680345
46	11	073680346
47	12	073680347
48	13	073680348



EN ISO 20345 2011

S3 SRC

7369UB

~~€ 97,00~~ € 55,80

Ascarì 

EU	UK	
35	2,5	073690235
36	3,5	073690236
37	4,5	073690237
38	5	073690238
39	6	073690239
40	6,5	073690240
41	7	073690241
42	8	073690242
43	9	073690243
44	10	073690244
45	10,5	073690245
46	11	073690246
47	12	073690247
48	13	073690248



470 g

**Scarpe in tessuto mesh ad alta traspirazione
con inserti in PU Alta Frequenza
e rinforzo protettivo del puntale in crosta scamosciata**

- Puntale in alluminio
- Lamina antiperforazione in fibra composita
- Sistema di chiusura FixLock, semplifica la calzata e lo sfilamento della scarpa (in dotazione anche stringhe tradizionali)



7340B

~~€ 128,00~~ € 72,70

FIT PRO NET

EU	UK	
36	3,5	073400236
37	4,5	073400237
38	5	073400238
39	6	073400239
40	6,5	073400240
41	7	073400241
42	8	073400242
43	9	073400243
44	10	073400244
45	10,5	073400245
46	11	073400246
47	12	073400247

7340Y

~~€ 128,00~~ € 72,70

FIT PRO NET

EU	UK	
36	3,5	073400336
37	4,5	073400337
38	5	073400338
39	6	073400339
40	6,5	073400340
41	7	073400341
42	8	073400342
43	9	073400343
44	10	073400344
45	10,5	073400345
46	11	073400346
47	12	073400347



EN ISO
20345
2011

S1P SRC



Novità

7340R

~~€ 128,00~~ € 72,70

FIT PRO NET

EU	UK	
36	3,5	073400436
37	4,5	073400437
38	5	073400438
39	6	073400439
40	6,5	073400440
41	7	073400441
42	8	073400442
43	9	073400443
44	10	073400444
45	10,5	073400445
46	11	073400446
47	12	073400447

7341N

~~€ 135,00~~ € 73,70

FIT PRO

EU	UK	
36	3,5	073410236
37	4,5	073410237
38	5	073410238
39	6	073410239
40	6,5	073410240
41	7	073410241
42	8	073410242
43	9	073410243
44	10	073410244
45	10,5	073410245
46	11	073410246
47	12	073410247

*Tomaia in microfibra
idrorepellente*



EN ISO
20345
2011

S1P SRC



EN ISO
20345
2011

S3 SRC

Calzature di sicurezza

Scarpe in pelle pieno fiore idrorepellente con copripuntale di rinforzo in poliuretano e suola VIBRAM® in PU/TPU. ESD

• Puntale in composito

• Lamina antiperforazione in fibra composita

Novità

7290NA

€ 143,00 € 82,00



EU	UK	
36	3,5	072900336
37	4,5	072900337
38	5	072900338
39	6	072900339
40	6,5	072900340
41	7	072900341
42	8	072900342
43	9	072900343
44	10	072900344
45	10,5	072900345
46	11	072900346
47	12	072900347
48	13	072900348



BASSA



S3 SRC ESD

Speed

Novità

7291NA

€ 151,00 € 87,00



EU	UK	
36	3,5	072910336
37	4,5	072910337
38	5	072910338
39	6	072910339
40	6,5	072910340
41	7	072910341
42	8	072910342
43	9	072910343
44	10	072910344
45	10,5	072910345
46	11	072910346
47	12	072910347
48	13	072910348



ALTA

Scarpe in pelle Nabuk ingrassata con dynamic control e suola in gomma VIBRAM® ad alta resistenza

• Puntale in composito

• Lamina antiperforazione in fibra composita

7293NKK

€ 161,00 € 92,00



EU	UK	
38	5	072930138
39	6	072930139
40	6,5	072930140
41	7	072930141
42	8	072930142
43	9	072930143
44	10	072930144
45	10,5	072930145
46	11	072930146
47	12	072930147
48	13	072930148



BASSA



S3 HRO SRC

7294NKK

€ 170,00 € 98,00



EU	UK	
38	5	072940138
39	6	072940139
40	6,5	072940140
41	7	072940141
42	8	072940142
43	9	072940143
44	10	072940144
45	10,5	072940145
46	11	072940146
47	12	072940147
48	13	072940148



ALTA

7816G

~~€ 60,50~~

€ 34,80

Pantaloni da lavoro multitasche

- T/C Canvas, 65% poliestere, 35% cotone, 260 g



XS	078160000
S	078160001
M	078160002
L	078160003
XL	078160004
XXL	078160005
XXXL	078160006



7816BL

~~€ 60,50~~

€ 34,80

Pantaloni da lavoro multitasche blu

- T/C Canvas, 65% poliestere, 35% cotone, 260 g

XS	078160100
S	078160101
M	078160102
L	078160103
XL	078160104
XXL	078160105
XXXL	078160106



- Tasche per ginocchiere e fondo gamba rinforzati in poliestere 600D
- Vita più alta nella parte posteriore per maggiore protezione della schiena
- Inserto posteriore elasticizzato per facilitare i movimenti
 - Vita elasticizzata ai lati
- Anello per portachiavi in vita
- Ampie tasche laterali con chiusura a bottoni automatici, una dotata di inserto portabadge
- Cavallo antistrappo

Novità

SLIM FIT

7880SC

~~€ 51,00~~

€ 29,00

Pantaloni da lavoro elasticizzati Slim fit

- T/C Canvas, 63% poliestere, 34% cotone, 3% tessuto elasticizzato, 290 g
- Cavallo antistrappo
- Tasca porta metro e fascia porta martello
- Inserti porta ginocchiere

XS	078800000
S	078800001
M	078800002
L	078800003
XL	078800004
XXL	078800005
XXXL	078800006

HEAVY STRETCH



7840BL

~~€ 31,50~~

€ 18,00

Pantaloni da lavoro

- T/C Twill, 65% poliestere, 35% cotone, 245 g
- Fascia porta martello
- Triple cuciture nei punti di maggiore usura
- Chiusura metal zip
- Tasca porta metro con inserti porta penne o piccoli utensili

XS	078400100
S	078400101
M	078400102
L	078400103
XL	078400104
XXL	078400105
XXXL	078400106
XXXXL	078400107



- Tasca laterale sinistro con chiusura a strappo ed inserto porta badge
 - Due ampie tasche anteriori
 - Vita elasticizzata ai lati
- Due tasche posteriori con chiusura a strappo

STRETCH

SLIM FIT

Novità

Workwear

7830ST

~~€ 50,00~~ € 28,50

Pantaloni da lavoro elasticizzati

• T/C Twill 250 g, grigio

XS	078300000
S	078300001
M	078300002
L	078300003
XL	078300004
XXL	078300005
XXXL	078300006



7831ST

~~€ 38,50~~ € 22,00

Bermuda da lavoro elasticizzati

• T/C Twill 250 g, grigio

XS	078310000
S	078310001
M	078310002
L	078310003
XL	078310004
XXL	078310005
XXXL	078310006



- Cavallo antistrappo
- Vita elasticizzata ai lati
- Due ampie tasche anteriori, di cui una con taschino
- Due tasche posteriori con chiusura a strappo
- Tascone laterale sinistro con chiusura a strappo, dotato di inserto portabadge
- Tasca porta metro e fascia porta martello

Novità

7835ST

~~€ 78,50~~ € 45,00

Tuta da lavoro elasticizzata

- T/C Twill 250 g, grigio
- Chiusura frontale con zip doppio cursore, coperta da patella con chiusura a strappo
- Polsini regolabili a strappo
- Tasca sinistra al petto con chiusura a strappo dotata di inserto portabadge
- Taschino destro al petto con chiusura a strappo ed inserti porta penne

XS	078350000
S	078350001
M	078350002
L	078350003
XL	078350004
XXL	078350005
XXXL	078350006



Novità

7833ST

~~€ 60,50~~ € 35,00

Salopette da lavoro elasticizzata

- T/C Twill 250 g, grigio
- Tascone al petto con chiusura a strappo
- Bretelle elasticizzate regolabili con sgancio rapido in materiale plastico

XS	078330000
S	078330001
M	078330002
L	078330003
XL	078330004
XXL	078330005
XXXL	078330006



- Cavallo antistrappo
- Vita elasticizzata
- Due tasche posteriori con chiusura a strappo
- Due ampie tasche anteriori, di cui una con taschino
- Tascone laterale sinistro con chiusura a strappo, dotato di inserto portabadge
- Tasca porta metro e fascia porta martello
- Inserti porta ginocchiere

7905E

~~€ 75,00~~ € 43,00

Tuta da lavoro

- In T/C Canvas, 65% poliestere, 35% cotone, 260 g



XS	079050900
S	079050901
M	079050902
L	079050903
XL	079050904
XXL	079050905
XXXL	079050906
XXXXL	079050907



7900E

~~€ 47,50~~ € 27,00

Pantaloni da lavoro multitasche

- In T/C Canvas, 65% poliestere, 35% cotone, 260 g

XS	079000900
S	079000901
M	079000902
L	079000903
XL	079000904
XXL	079000905
XXXL	079000906
XXXXL	079000907



7903E

~~€ 59,50~~ € 34,00

Salopette da lavoro

- In T/C Canvas, 65% poliestere, 35% cotone, 260 g

XS	079030900
S	079030901
M	079030902
L	079030903
XL	079030904
XXL	079030905
XXXL	079030906
XXXXL	079030907



7901E

~~€ 38,50~~ € 22,00

Bermuda da lavoro

- In T/C Canvas, 65% poliestere, 35% cotone, 260 g

XS	079010900
S	079010901
M	079010902
L	079010903
XL	079010904
XXL	079010905
XXXL	079010906
XXXXL	079010907



7907E

~~€ 44,50~~ € 25,50

Gilet multitasche da lavoro

- In T/C Canvas, 65% poliestere, 35% cotone, 260 g

XS	079070900
S	079070901
M	079070902
L	079070903
XL	079070904
XXL	079070905
XXXL	079070906
XXXXL	079070907



7909E

~~€ 53,00~~ € 30,40

Giacca da lavoro

- In T/C Canvas, 65% poliestere, 35% cotone, 260 g

XS	079090900
S	079090901
M	079090902
L	079090903
XL	079090904
XXL	079090905
XXXL	079090906
XXXXL	079090907



7865E

~~€ 69,00~~ € 39,50

Tuta leggera da lavoro

- T/C twill, 65% poliestere, 35% cotone, 180 g



XS	078650900
S	078650901
M	078650902
L	078650903
XL	078650904
XXL	078650905
XXXL	078650906
XXXXL	078650907



7860E

~~€ 44,00~~ € 25,40

Pantaloni leggeri da lavoro

- T/C twill, 65% poliestere, 35% cotone, 180 g

XS	078600900
S	078600901
M	078600902
L	078600903
XL	078600904
XXL	078600905
XXXL	078600906
XXXXL	078600907



7863E

~~€ 53,50~~ € 30,70

Salopette leggera da lavoro

- T/C twill, 65% poliestere, 35% cotone, 180 g

XS	078630900
S	078630901
M	078630902
L	078630903
XL	078630904
XXL	078630905
XXXL	078630906
XXXXL	078630907



7861E

~~€ 36,50~~ € 21,00

Bermuda leggeri da lavoro

- T/C twill, 65% poliestere, 35% cotone, 180 g

XS	078610900
S	078610901
M	078610902
L	078610903
XL	078610904
XXL	078610905
XXXL	078610906
XXXXL	078610907



7867E

~~€ 40,50~~ € 23,00

Gilet multitasche leggero da lavoro

- T/C twill, 65% poliestere, 35% cotone, 180 g

XS	078670900
S	078670901
M	078670902
L	078670903
XL	078670904
XXL	078670905
XXXL	078670906
XXXXL	078670907



7869E

~~€ 47,50~~ € 27,00

Giacca leggera da lavoro

- T/C twill, 65% poliestere, 35% cotone, 180 g

XS	078690900
S	078690901
M	078690902
L	078690903
XL	078690904
XXL	078690905
XXXL	078690906
XXXXL	078690907



7875E

~~€ 69,00~~ € 39,50

Tuta leggera da lavoro

- T/C twill, 65% poliestere, 35% cotone, 180 g



XS	078750900
S	078750901
M	078750902
L	078750903
XL	078750904
XXL	078750905
XXXL	078750906
XXXXL	078750907

7870E

~~€ 44,00~~ € 25,40

Pantaloni leggeri da lavoro

- T/C twill, 65% poliestere, 35% cotone, 180 g

XS	078700900
S	078700901
M	078700902
L	078700903
XL	078700904
XXL	078700905
XXXL	078700906
XXXXL	078700907



7873E

~~€ 53,50~~ € 30,70

Salopette leggera da lavoro

- T/C twill, 65% poliestere, 35% cotone, 180 g

XS	078730900
S	078730901
M	078730902
L	078730903
XL	078730904
XXL	078730905
XXXL	078730906
XXXXL	078730907



7871E

~~€ 36,50~~ € 21,00

Bermuda leggeri da lavoro

- T/C twill, 65% poliestere, 35% cotone, 180 g

XS	078710900
S	078710901
M	078710902
L	078710903
XL	078710904
XXL	078710905
XXXL	078710906
XXXXL	078710907



7877E

~~€ 40,50~~ € 23,00

Gilet multitasche leggero da lavoro

- T/C twill, 65% poliestere, 35% cotone, 180 g

XS	078770900
S	078770901
M	078770902
L	078770903
XL	078770904
XXL	078770905
XXXL	078770906
XXXXL	078770907



7879E

~~€ 47,50~~ € 27,00

Giacca leggera da lavoro

- T/C twill, 65% poliestere, 35% cotone, 180 g

XS	078790900
S	078790901
M	078790902
L	078790903
XL	078790904
XXL	078790905
XXXL	078790906
XXXXL	078790907





SPEEDUP
Racing Spirit

50
years in
motorsports



 **Beta**
www.beta-tools.it



 **Beta**

Beta Utensili S.p.A.
Via Volta 18
20845 Sovico (MB)
Tel. 039.2077.1
Fax 039.2010742
www.beta-tools.it

Promozione valida dal 15/01/2018 al 14/12/2018. Prezzi netti I.V.A. esclusa

Le immagini sono indicative, Beta si riserva il diritto di apportare aggiornamenti e migliorie alla propria gamma produttiva senza alcun preavviso.