

# Beta Action



Promozione valida  
dal **13/01/2020** al **14/12/2020**  
Prezzi netti I.V.A. esclusa

**220**  
**200**



# Beta

## RSC55



360°  
view

*Configura on-line  
la tua officina*



[www.rsc55.it](http://www.rsc55.it)





Una soluzione per ogni esigenza...

Scegli la cassettera che fa al caso tuo!



	RAL 2011			RAL 7016			RAL 3000											
	800 x 971 x 500 mm			800 x 1026 x 500 mm			740 x 955 x 445 mm			1050 x 973 x 565 mm			1050 x 973 x 565 mm			1035 x 970 x 445 mm		
	588 x 367 mm			588 x 367 mm			588 x 367 mm			588 x 367 mm			588 x 367 mm			882 x 367 mm		
	6	7	8	6	7	8	6	7	8	7	7	7	8	9				
70 mm - 30 kg	4	5	6	-	-	-	4	5	6	5	5	5	6	8				
75 mm - 30 kg	-	-	-	4	5	6	-	-	-	-	-	-	-	-				
140 mm - 35 kg	1	1	2	-	-	-	1	1	2	1	1	1	2	1				
150 mm - 35 kg	-	-	-	1	1	2	-	-	-	-	-	-	-	-				
210 mm - 35 kg	-	1	-	-	-	-	-	1	-	1	1	1	-	-				
225 mm - 35 kg	-	-	-	-	1	-	-	-	-	-	-	-	-	-				
280 mm - 35 kg	1	-	-	-	-	-	1	-	-	-	-	-	-	-				
305 mm - 35 kg	-	-	-	1	-	-	-	-	-	-	-	-	-	-				
	59 kg	61 kg	64 kg	69 kg	71 kg	73 kg	55 kg	58 kg	61 kg	82 kg	80 kg	84 kg	88 kg	90 kg				

Abbina il tuo assortimento

5988U6/MP (214)			✓			✓		✓				✓	✓	
5904U/MP (91)	✓	✓	✓	✓	✓	✓	✓	✓	✓	✓	✓	✓	✓	✓
5904VAT (102)	✓	✓	✓	✓	✓	✓	✓	✓	✓	✓	✓	✓	✓	✓



Qualità certificata.

Le nostre cassettere hanno superato con successo i 31 test costruttivi previsti dal TÜV, ottenendo l'ambita certificazione di qualità.





RSC 55

## POSTAZIONE DI LAVORO COMPOSTA DA:

**C55PRO B0/2****Banco con piano da lavoro**

da 2050x700 mm rivestito da uno strato di PVC antiurto e antigraffio resistente agli idrocarburi

- Fori per la collocazione di una morsa 1599F/150 (da ordinare separatamente)
- Piedini regolabili in altezza
- Prese elettriche e arrotolatore integrati

**C55C7****Cassettiera mobile con 7 cassetti**

da 588x367 mm, montati su guide telescopiche a sfera

- 4 ruote Ø 100 mm, 2 fisse e 2 girevoli (una con freno)
- Piano dei cassetti protetto da tappetini di gomma espansa
- Serratura centralizzata frontale

**C55M7****Modulo fisso con 7 cassetti**

da 588x367 mm, montati su guide telescopiche a sfera

- Piano dei cassetti protetto da tappetini di gomma espansa
- Serratura centralizzata frontale

**C55PB-PRO/5****Postazione da lavoro per arredo officina RSC55**

con tapparella e struttura portante

- Tapparella in alluminio, manovrabile verticalmente, con serratura
- Pannello forato amovibile per il sostegno degli utensili

055000025 346 kg

€ 6.290,00 € 3.600,00

**C55PB-PRO/5E****Postazione da lavoro per arredo officina RSC55 con tapparella e predisposizione per 2 prese elettriche (non incluse)**

- Fornita con struttura portante
- Tapparella in alluminio, manovrabile verticalmente, con serratura
- Pannello forato amovibile per il sostegno degli utensili

055000026 346 kg

€ 6.310,00 € 3.610,00



Predisposizione per l'inserimento dei termoformati.



Presca Schuko +16+10A  
Presca EU Plug +10A



La cassettiera C55C7 è facilmente estraibile da parte dell'operatore grazie alle ruote girevoli.



Presca per aria compressa con arrotolatore da Ø 8 mm. Lunghezza: 10 m





# C37

## Cassettera mobile

Caratteristiche principali:

- Piano di lavoro multifunzione ad alta resistenza
- Sistema di apertura a sgancio rapido in alluminio posizionato su tutta la lunghezza del cassetto
- **Paracolpi angolari morbidi** su tutta l'altezza della cassettera per evitare, in caso di urto, il danneggiamento dei veicoli all'interno dell'officina
- Quattro ruote Ø 125 mm: 2 fisse e 2 girevoli (una con freno)

**Novità**



<b>C37/6</b>	037000061	037000062	037000063	<del>€ 860,00</del>	€ 495,00
<b>C37/7</b>	037000071	037000072	037000073	<del>€ 890,00</del>	€ 510,00
<b>C37/8</b>	037000081	037000082	037000083	<del>€ 920,00</del>	€ 525,00



# C37A/7

Cassettera mobile con 7 cassetti  
Con sistema antiribaltamento



**Novità**



<b>C37A/7</b>	037000271	037000272	037000273	<del>€ 915,00</del>	€ 523,00
---------------	-----------	-----------	-----------	---------------------	----------

**Sistema antiribaltamento**



## ACCESSORI C37

**Novità**

### 3700/PLA

Piano di lavoro in acciaio inossidabile



037000100

2,8 kg

672x396x1,5 mm

~~€ 53,00~~ € 30,50

### 3700/PLL

Piano di lavoro in legno, con predisposizione per morsa 1599P/100 (da ordinare separatamente)



037000101

3,9 kg

672x396x28 mm

~~€ 65,00~~ € 37,50

### 3700/PF

Pannello forato con supporti



650x626x80 mm

037000102

3,2 kg

~~€ 51,00~~ € 29,50

### 3700/PFL

Pannello forato laterale



754x321x38 mm

037000104

1,9 kg

~~€ 28,50~~ € 16,50

### 3700/PC

Supporto porta computer, con cassetto estraibile



418x303x399 mm

037000103

3,1 kg

~~€ 70,00~~ € 40,50

## C39

Cassettiera mobile

- Quattro ruote con nucleo in acciaio  
Ø 125 mm: 2 fisse e 2 girevoli (una con freno)
- Serratura di sicurezza centralizzata frontale



Piano di lavoro multifunzione ad alta resistenza con portaminuterie e fori per l'alloggiamento dei giravite



Sistema di apertura a sgancio rapido in alluminio posizionato su tutta la lunghezza del cassetto



Aluminium<sup>AL</sup>

**Struttura portante in lega di alluminio + RESISTENZA + LEGGEREZZA**

Portacarta e portafaconi laterali e posteriori integrati.



C39/6	039000031	039000032	039000033	<del>€ 1.285,00</del>	€ 714,00
C39/7	039000001	039000002	039000003	<del>€ 1.360,00</del>	€ 759,00
C39/8	039000041	039000042	039000043	<del>€ 1.450,00</del>	€ 804,00





## C24S

### Cassettiera mobile

- Quattro ruote con nucleo in acciaio Ø 125 mm: 2 fisse e 2 girevoli (una con freno)
- Serratura di sicurezza centralizzata
- Possibilità di applicazione del portacarta 2400S-R/PC (da ordinare separatamente)



Cassetto ad estrazione totale con sistema di apertura in nylon rinforzato in fibra di vetro posizionato su tutta la lunghezza del cassetto.



Piano di lavoro in ABS ad alta resistenza



Portaflaconi laterale integrato.



C24S/6	024002061	024002062	024002063			<del>€ 730,00</del>	€ 413,00
C24S/7	024002071	024002072	024002073	024002076	024002079	<del>€ 790,00</del>	€ 448,00
C24S/8	024002081	024002082	024002083			<del>€ 850,00</del>	€ 485,00



## C24SA-XL

### Cassettiera mobile con sistema antiribaltamento, modello lungo

- Quattro ruote con nucleo in acciaio Ø 125 mm: 2 fisse e 2 girevoli (una con freno)
- Serratura di sicurezza centralizzata frontale
- Possibilità di applicazione del portacarta 2400S-R/PC (da ordinare separatamente)

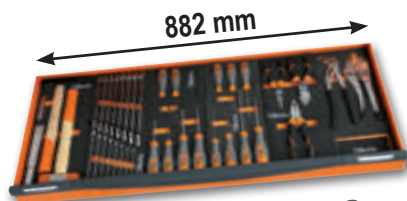

**può contenere 6 moduli**

Cassetto ad estrazione totale con sistema di apertura in nylon rinforzato in fibra di vetro posizionato su tutta la lunghezza del cassetto con porta-etichette integrato.

Portaflaconi laterale integrato.



C24SA-XL/7	024002271	024002272	024002273	<del>€ 1.055,00</del>	€ 599,00
C24SA-XL/8	024002281	024002282	024002283	<del>€ 1.130,00</del>	€ 645,00
C24SA-XL/9	024002331	024002332	024002333	<del>€ 1.200,00</del>	€ 689,00



**Sistema antiribaltamento**



## C24SL-CAB

### Cassettiera mobile con 7 cassetti e armadietto porta-oggetti

- Quattro ruote con nucleo in acciaio Ø 125 mm: 2 fisse e 2 girevoli (due con freno)
- Serratura centralizzata frontale
- Portacarta integrato



Armadietto laterale portaoggetti con ripiano interno regolabile in altezza e ante richiudibile con serratura.



Doppio portaflaconi posteriore.

Piano di lavoro in legno multistrato con fori per la collocazione di una morsa 1599F/100 (da ordinare separatamente).



C24SL-CAB

024002191

024002192

024002193

~~€ 1.210,00~~

€ 695,00



## C24SL

### Cassettiera mobile con 7 cassetti e ripiani laterali

- 7 cassetti da 588x367 mm, montati su guide telescopiche a sfera
- 3 portaflaconi e portacarta integrati
- Vano laterale con ripiano regolabile in altezza
- Serratura di sicurezza centralizzata frontale
- 4 ruote Ø 125 mm: 2 fisse e 2 girevoli (2 con freno)
- Piano dei cassetti protetto da tappetini di gomma espansa 1599F/100 da ordinare separatamente



Piano di lavoro in legno multistrato con fori per la collocazione di una morsa 1599F/100 (da ordinare separatamente).



C24SL

024002101

024002102

024002103

~~€ 1.175,00~~

€ 675,00





## C28

### Carrello SuperTank con piano di lavoro e 10 cassetti

- Cinque cassetti laterali e cinque cassetti frontali
- Quattro ruote con nucleo in acciaio Ø 150 mm: 2 fisse e 2 girevoli con freno
- 2 serrature di sicurezza centralizzate
- 4 portaflaconi: 2 frontali e 2 posteriori
- 6 vaschette portaminuterie laterali
- Vano passante altezza 135 mm con base ricoperta in materiale plastico

Piano di lavoro in legno multistrato con fori per la collocazione di una morsa 1599F/150 (da ordinare separatamente).

n°	h	max.
8	70 mm	25 kg
2	210 mm	30 kg

kg  
1200



Sistema rapido e sicuro per l'apertura e chiusura dei cassetti con frontalino in nylon e fibra di vetro.



Vano laterale con antina di chiusura a scomparsa con serratura.



130 kg



C28	028000301	028000302	028000303	<del>€ 2.085,00</del>	€ 1.199,00
-----	-----------	-----------	-----------	-----------------------	------------

## Novità

### PROTEZIONI IN NYLON PER CASSETTIERE

#### 2400-COVER C24S

Protezione in nylon per

- C24S
- C24SA
- C39



024000910	<del>€ 17,00</del>	€ 9,90
-----------	--------------------	--------

#### 2400-COVER C24SA-XL

Protezione in nylon per

- C24SA/XL
- C24SL
- C24SL-CAB



024000930	<del>€ 23,00</del>	€ 13,30
-----------	--------------------	---------

#### 3700-COVER C37

Protezione in nylon per

- C37



037000930	<del>€ 23,50</del>	€ 13,60
-----------	--------------------	---------

#### 4100-COVER C41H

Protezione in nylon per

- C41H



041000930	<del>€ 18,00</del>	€ 10,40
-----------	--------------------	---------



## C54S

### Armadietti Cargo, vuoti

Sono realizzati sulla base di accurate ricerche presso qualificati utilizzatori professionali ed offrono le soluzioni ideali per operare in modo confortevole e razionale. L'apertura dei pannelli forati delle due antine permette lo sfruttamento anche della loro superficie interna.

Caratteristiche principali:

- 1 cassetto montato su guide telescopiche
- Possibilità di modificare facilmente la disposizione degli utensili in funzione delle proprie esigenze
- Posizionamento a parete per mezzo di due asole situate posteriormente
- Serratura per chiusura contemporanea di antine e cassetto
- Termoformato vuoto per bussole e accessori da 1/2"



**Novità**



980 mm

1555 mm

303 mm

796 mm

37 kg



C54S

054000301

054000302

054000303

~~€ 545,00~~

€ 309,00

## C04TSS/7

### Cassettiera mobile con 7 cassetti in acciaio inossidabile, con ruote antitraccia

- Sette cassetti da 570 x 410 mm montati su guide telescopiche a sfera
- 6 cassetti altezza 83 mm
- 1 cassetto altezza 170 mm
- quattro ruote antitraccia con nucleo in acciaio inossidabile Ø 125mm, 2 fisse e 2 girevoli (due con freno)
- Serratura frontale centralizzata
- Struttura interamente in acciaio inossidabile AISI 304
- Ruote, supporti, sfere, interno dei cassetti e relative guide in acciaio inossidabile
- Maniglia cassetti in alluminio

Altri prodotti inox pagg. 16 - 22 - 25 - 30 - 37



**Beta**  
**INOX**  
STAINLESS STEEL



**kg**  
**700**

935 mm

470 mm

680 mm

**Ruote antitraccia**

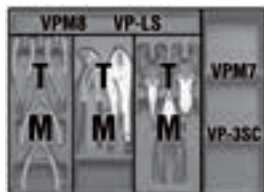

n°	h	max.
6	83 mm	25 kg
1	170 mm	30 kg

024003077

63 kg

~~€ 2.140,00~~ € 1.219,00



5988U6/MP



Assortimento di 214 utensili  
in termoformato morbido

consigliato in abbinamento con le cassette:  
C24S-C24SL-C37-C39-C28-C24SLCAB-C59-RSC55

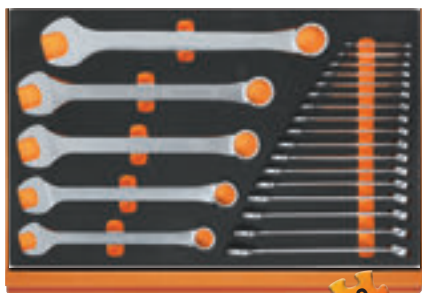

M10

22



M30

31

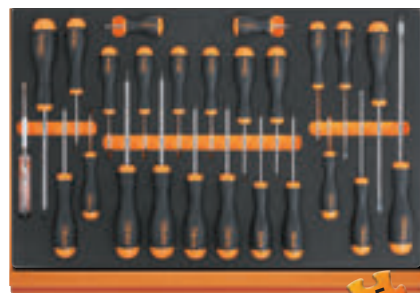

M210

25

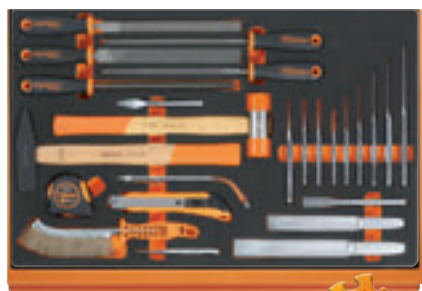

M230

25



M130

13

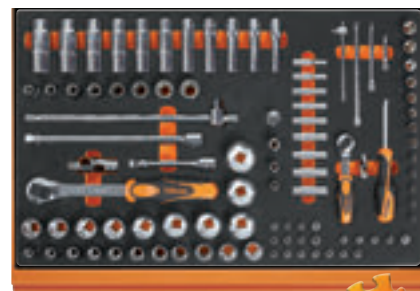

M100

98

N. pezzi/Descrizione

- 22 chiavi combinate 6-7-8-9-10-11-12-13-14-15-16-17-18-19-20-21-22-24-27-30-32-36 mm
- 11 chiavi a forchetta 6x7-8x9-10x11-12x13-14x15-16x17-18x19-20x22-21x23-24x27-30x32 mm
- 11 chiavi poligonali curve 6x7-8x9-10x11-12x13-14x15-16x17-18x19-20x22-21x23-24x27-30x32 mm
- 9 chiavi maschio esagonale piegate con estremità sferica  $\varnothing$  1,5-2-2,5-3-4-5-6-8-10 mm
- 6 giravite lama piatta  $\bullet$  2,5x50-3x75-4x100-5,5x125-6,5x150-8x200 mm
- 1 giravite per viti a testa con intaglio  $\bullet$  4x30 mm
- 4 giravite Phillips®  $\oplus$  PH0x60-PH1x80-PH2x100-PH3x150 mm
- 1 giravite Phillips®  $\oplus$  PH1x30 mm
- 12 chiavi maschio con impugnatura per viti con impronta Torx®  $\odot$  T6-T7-T8-T9-T10-T15-T20-T25-T27-T30-T40-T45
- 1 giravite cercafase  $\bullet$
- 3 punzoni  $\varnothing$  2-3-4 mm
- 6 cacciaspina  $\varnothing$  2-3-4-5-6-8 mm
- 1 bulino  $\varnothing$  4 mm
- 1 scalpelli piatti 150 mm
- 2 scalpelli piatti nervati 200-250 mm
- 1 ugnetti 125 mm
- 1 martello tipo tedesco 500 g
- 1 mazzuola con battenti in materiale plastico  $\varnothing$  35 mm
- 1 flessometro 3 m
- 1 magnete telescopico con testa flessibile
- 1 lima 200 mm
- 1 lima 200 mm
- 1 lima 200 mm
- 1 lima 200 mm
- 1 lima 200 mm
- 1 spazzola fili d'acciaio
- 1 cutter con lama a settori 18 mm

Beta N.	TR
42	M10
55	M30
90	M30
96BPC/SC9	M30
1201	M210
1201N	M210
1202	M210
1202N	M210
1207TX	M210
1253	M210
30	M230
31	M230
32	M230
34	M230
35	M230
36	M230
1370	M230
1390	M230
1692	M230
1712TF	M230
1719BMA...Q	M230
1719BMA...T	M230
1719BMA...P	M230
1719BMA...M	M230
1719BMA...R	M230
1737NX	M230
1771	M230

N. pezzi/Descrizione

- 1 pinze becchi dritti per anelli elastici, per fori  $\varnothing$  180 mm
- 1 pinze becchi piegati per anelli elastici, per fori  $\varnothing$  170 mm
- 1 pinze becchi dritti per anelli elastici, per alberi  $\bullet$  175 mm
- 1 pinze becchi piegati per anelli elastici, per alberi  $\bullet$  175 mm
- 1 pinze regolabili cerniera chiusa 250 mm
- 1 pinza autobloccante 240 mm
- 1 tronchese a taglienti diagonali  $\nabla$  160 mm
- 1 tenaglie per cementisti 220 mm
- 1 cesoia a lame larghe diritte 250 mm
- 1 forbici per elettricisti lame dritte
- 1 pinza universale  $\equiv$  180 mm
- 1 pinza a becchi mezzotondi dritti  $\bullet$  160 mm
- 1 pinza a becchi mezzotondi piegati  $\bullet$  160 mm
- 1 bussola portainserti
- 1 bussola portainserti
- 1 bussola portainserti
- 13 chiavi a bussola esagonali 1/4"  $\odot$  4-4,5-5-5,5-6-7-8-9-10-11-12-13-14 mm
- 9 chiavi a bussola a mano lunghe bocca esagonale  $\odot$  5-6-7-8-9-10-11-12-13 mm
- 5 chiavi a bussola maschio esagonale 1/4"  $\odot$  3-4-5-6-7 mm
- 4 chiavi a bussola a giravite per viti con intaglio  $\bullet$  0,8x4-1x5,5-1,2x6,5-1,2x8 mm
- 4 chiavi a bussola a giravite per viti con impronta a croce Phillips®  $\oplus$  PH1-PH2-PH3-PH4
- 7 chiavi a bussola a giravite maschio per viti con impronta Torx®  $\odot$  T10-T15-T20-T25-T27-T30-T40
- 1 prolunga - 1/4" 50 mm
- 1 prolunga - 1/4" 100 mm
- 1 prolunga - 1/4" 150 mm
- 1 snodo 1/4"
- 1 quadro con impugnatura 1/4"
- 1 quadro scorrevole 1/4"
- 1 cricchetto reversibile 1/4"  $\oplus$
- 21 chiavi a bussola esagonali 1/2"  $\odot$  8-10-11-12-13-14-15-16-17-18-19-20-21-22-23-24-26-27-28-30-32 mm
- 1 raccordo con attacco quadro 125 mm
- 1 snodo 1/2" 250 mm
- 1 prolunga angolare - 1/2"
- 1 prolunga angolare - 1/2"
- 1 quadro maschio 1/2" con spina scorrevole
- 1 cricchetto reversibile 1/2"  $\oplus$
- 8 chiavi a bussola 1/2" per viti con teste a profilo Torx®  $\odot$  10-12-14-16-18-20-22-24 mm
- 11 chiavi a bussola a mano lunghe bocca esagonale  $\odot$  10-12-13-14-15-16-17-18-19-21-22 mm

Beta N.	TR
1032	M130
1034	M130
1036	M130
1038	M130
1048	M130
1052	M130
1082BM	M130
1098	M130
1112	M130
1128BM	M130
1150BM	M130
1166BM	M130
1168BM	M130
895/1	M100
895/3	M100
895/6	M100
900	M100
900L	M100
900ME	M100
900LP	M100
900PH	M100
900TX	M100
900/20	M100
900/20L	M100
900/21	M100
900/25	M100
900BG/30	M100
900/42	M100
900/55	M100
920A	M100
920/15	M100
920/25	M100
920AN/125	M100
920AN/250	M100
920/42	M100
920/55	M100
920FTX	M100
920AL	M100

059880535

24 kg

€ 2.570,00 € 1.465,00





## 5904U/MP



Assortimento di 91 utensili  
in termoformato morbido

consigliato in abbinamento con le cassettiere:  
C24S-C24SL-C37-C39-C28-C24SLCAB-C59-RSC55



M15 M33 M199 M202



M50 M83



M132 M153 M234 M145

### N. pezzi/Descrizione

- 16 chiavi combinate 6÷21 mm
- 8 chiavi a forchetta 6x7 - 8x9 - 10x11 - 12x13 - 14x15 - 16x17 - 18x19 - 20x22 mm
- 9 chiavi maschio esagonale piegate  $\odot$  1,5 - 2 - 2,5 - 3 - 4 - 5 - 6 - 8 - 10 mm
- 7 giravite lama piatta  $\bullet$  2,5x50 - 3x75 - 3,5x100 - 4x125 - 5,5x100 - 5,5x150 - 6,5x150 mm
- 6 giravite per viti con impronta a croce Phillips®  $\oplus$  PH0x60 - PH0x100 - PH1x80 - PH1x120 - PH2x100 - PH2x150 mm
- 8 chiavi maschio esagonale con impugnatura  $\odot$  2-2,5-3-4-5-6-7-8 mm
- 1 prolunga angolare - 1/2" 125 mm
- 1 prolunga angolare - 1/2" 250 mm
- 1 snodo 1/2"
- 1 quadro maschio 1/2" con spina scorrevole

Beta N.	TR
42	M15
55	M33
96/SC9	M33
1260	M199
1262	M202
96T	M50
920AN/125	M83
920AN/250	M83
920/25	M83
920/42	M83

### N. pezzi/Descrizione

- 1 cricchetto reversibile 1/2"  $\oplus$
- 19 chiavi a bussola esagonali 1/2"  $\odot$  10÷24 - 26 - 27 - 30 - 32 mm
- 1 tronchesi a grande effetto taglienti diagonali  $\nabla$  160 mm
- 1 pinza universale  $\equiv$  180 mm
- 1 pinza a becchi mezzotondi dritti  $\bullet$  160 mm
- 1 pinze regolabili cerniera chiusa 250 mm
- 1 pinza autobloccante 240 mm
- 2 scalpelli piatti nervati 100 - 200 mm
- 1 martello tipo tedesco 300 g
- 1 mazzuola con battenti in materiale plastico  $\varnothing$  35 mm
- 1 pinze becchi dritti per anelli elastici, per fori  $\odot$  180 mm
- 1 pinze becchi piegati per anelli elastici, per fori  $\odot$  170 mm
- 1 pinze becchi dritti per anelli elastici, per alberi  $\bullet$  175 mm
- 1 pinze becchi piegati per anelli elastici, per alberi  $\bullet$  175 mm

Beta N.	TR
920/55	M83
920A	M83
1084	M132
1150	M132
1166	M132
1048	M153
1052	M153
35	M234
1370	M234
1390	M234
1032	M145
1034	M145
1036	M145
1038	M145

059040425 12 kg  
€ 1.095,00 € 625,00



## 5904VA/T



Assortimento di 102 utensili  
in termoformato rigido

consigliato in abbinamento con le cassettiere:  
C24S-C24SL-C37-C39-C28-C24SLCAB-C59-RSC55



T199 T202 T83



T145 T153 T131 T234



T52 T33 T15 T16



T63 VP5

### N. pezzi/Descrizione

- 21 chiavi combinate 6-7-8-9-10-11-12-13-14-15-16-17 - 18-19-20-21-22-24-27-30-32 mm
- 8 chiavi a forchetta 6x7-8x9-10x11-12x13-14x15 - 16x17-18x19-20x22 mm
- 9 chiavi maschio esagonale piegate  $\odot$  1,5÷10 mm
- 6 chiavi maschio esagonale con impugnatura  $\odot$  2-2,5-3-4-5-6 mm
- 8 chiavi a T con bussola snodata  $\odot$  7-8-10-12-13-14-17-19 mm
- 19 chiavi a bussola esagonali 1/2"  $\odot$  10-11-12-13-14-15-16-17-18-19 - 20-21-22-23-24-26-27-30-32 mm
- 1 prolunga - 1/2" 125 mm
- 1 prolunga - 1/2" 255 mm
- 1 snodo 1/2"
- 1 quadro maschio 1/2" con spina scorrevole 305 mm
- 1 cricchetto reversibile 1/2"  $\oplus$
- 1 tronchesi a grande effetto taglienti diagonali  $\nabla$  160 mm
- 1 pinza universale  $\equiv$  180 mm

Beta N.	TR
42	T15
	+T16
55	T33
96/SC9	T33
96T	T52
952	T63
920A	T83
920/21	T83
920/22	T83
920/25	T83
920/42	T83
920/55	T83
1084BM	T131
1150BM	T131

### N. pezzi/Descrizione

- 1 pinza a becchi mezzotondi dritti  $\bullet$  160 mm
- 1 pinze becchi dritti per anelli elastici, per fori  $\odot$  180 mm
- 1 pinze becchi piegati per anelli elastici, per fori  $\odot$  170 mm
- 1 pinze becchi dritti per anelli elastici, per alberi  $\bullet$  175 mm
- 1 pinze becchi piegati per anelli elastici, per alberi  $\bullet$  175 mm
- 1 pinza autobloccante 240 mm
- 1 pinze regolabili cerniera chiusa 250 mm
- 7 giravite lama piatta  $\bullet$  2,5x50 - 3x75 - 3,5x100 - 4x125 - 5,5x100 - 5,5x150 - 6,5x150 mm
- 6 giravite per viti con impronta a croce Phillips®  $\oplus$  PH0x60 - PH0x100 - PH1x80 - PH1x120 - PH2x100 - PH2x150 mm
- 2 scalpelli piatti nervati 100-200 mm
- 1 martello tipo tedesco 300 g
- 1 mazzuola con battenti in materiale plastico  $\varnothing$  35 mm
- 1 termoformato vuoto

Beta N.	TR
1166BM	T131
1032	T145
1034	T145
1036	T145
1038	T145
1052	T153
1048	T153
1260	T199
1262	T202
35	T234
1370	T234
1390	T234
VP5	VP5

059040415 17 kg  
€ 1.435,00 € 815,00





## M10

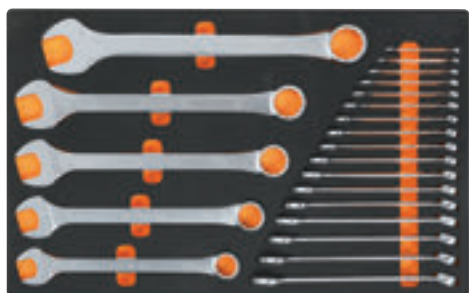

42 6-7-8-9-10-11-12-13-14-15-16-17-18-19-20-21-22-24-27-30-32-36 mm

024500010 4,5 kg  
~~€ 367,00~~ € 213,00

## M30



55 6x7-8x9-10x11-12x13-14x15-16x17-18x19-20x22-21x23-24x27-30x32 mm  
 90 6x7-8x9-10x11-12x13-14x15-16x17-18x19-20x22-21x23-24x27-30x32 mm  
 96BPC/SC9 1,5-2-2,5-3-4-5-6-8-10 mm

024500030 4,2 kg  
~~€ 335,00~~ € 194,00

## M60



○ 96T 2-2,5-3-4-5-6-7-8-10 mm  
 ○ 97BTX/SC8 T9-T10-T15-T20-T25-T27-T30-T40  
 ○ 944BX 5-6-7-8-10-13 mm

024500060 1,9 kg  
~~€ 313,00~~ € 181,00

## M63



○ 952 7-8-10-12-13-14-17-19 mm

024500063 3,4 kg  
~~€ 284,00~~ € 164,00

## M100

12" 14"

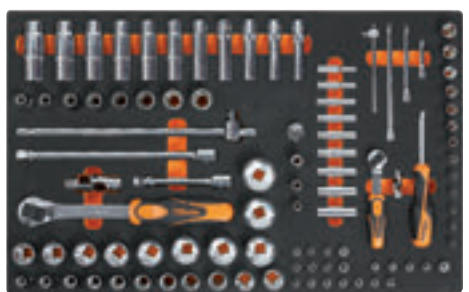

895/1 - 895/3 - 895/6  
 ○ 900 4-4,5-5-5,5-6-7-8-9-10-11-12-13-14 mm  
 ○ 900L 5-6-7-8-9-10-11-12-13 mm  
 ○ 900ME 3-4-5-6-7 mm  
 ● 900LP 0,8x4-1x5,5-1,2x6,5-1,2x8 mm  
 ● 900PH PH1-PH2-PH3-PH4  
 ○ 900TX T10-T15-T20-T25-T27-T30-T40  
 900/20 50 mm 900/20L 100 mm  
 900/21 150 mm  
 900/25 - 900BG/30 - 900/42  
 ● 900/55  
 ○ 920A 8-10-11-12-13-14-15-16-17-18-19-20-21-22-23-24-26-27-28-30-32 mm  
 920/15 - 920/25  
 920AN/125 125 mm  
 920AN/250 250 mm  
 920/42  
 ● 920/55  
 ● 920FTX 10-12-14-16-18-20-22-24 mm  
 ○ 920AL 10-12-13-14-15-16-17-18-19-21-22 mm

024500100 6,7 kg  
~~€ 1.018,00~~ € 590,00

## M105

12" 14" 3/8"



○ 900 4-4,5-5-5,5-6-7-8-9-10-11-12-13-14 mm  
 ○ 900L 5-6-7-8-9-10-11-12-13 mm  
 ○ 96BPC/SC9 1,5-2-2,5-3-4-5-6-8-10 mm  
 895/1 - 895/3 - 895/6  
 ○ 900ME 3-4-5-6-7 mm  
 ● 900LP 0,8x4-1x5,5-1,2x6,5-2x8 mm  
 ● 900PH PH1-PH2-PH3-PH4  
 ○ 900TX T10-T15-T20-T25-T27-T30-T40  
 900/16 □ 1/4 - ■ 3/8  
 900/... 50-100-150 mm  
 900/25 - 900BG/30 - 900/42  
 ● 900/55  
 ○ 910A 6-7-8-9-10-11-12-13-14-15-16-17-18-19-20-21-22 mm  
 910/15 □ 3/8 - ■ 1/4  
 910/16 □ 3/8 - ■ 1/2  
 910/21 125 mm  
 910/22 250 mm  
 910/25 - 910/42  
 ● 910/55  
 ○ 920A 8-10-11-12-13-14-15-16-17-18-19-20-21-22-23-24-26-27-28-30-32 mm  
 920/15 □ 1/2 - ■ 3/8  
 920/25  
 920AN 125 - 250 mm  
 920/42  
 ● 920/55  
 ○ 956E 16-17,8-20,8 mm

024500871 7,7 kg  
~~€ 1.108,00~~ € 635,00



## M120

12"



- 920A 10-11-12-13-14-15-16-17-18-19-20-21-22-24-26-27-30-32 mm
- 920AN/125 125 mm
- 920AN/250 250 mm
- 920/25 - 920/42
- 920AL 10-12-13-14-15-16-17-18-19-22-24-27-30-32 mm
- 920FTX 10-12-14-16-18-20-22-24 mm
- 920/55
- 920PE 5-5L-6-6L-7-7L-8-8L-10-10L-12-12L-14-14L
- 920TX T20-T25-T27-T30-T40-T45-T50-T55-T60-T20L-T25L-T27L-T30L-T40L-T45L-T50L

024500120 6,9 kg

€ 1.090,00 € 628,00

## M130



- 1032 180 mm
- 1034 170 mm
- 1036 175 mm
- 1038 175 mm
- 1048 250 mm
- 1052 240 mm
- ⚡ 1082BM 160 mm
- 1098 220 mm
- 1112 250 mm
- 1128BM
- 1150BM 180 mm
- 1166BM 160 mm
- 1168BM 160 mm

024500130 3,4 kg

€ 347,00 € 201,00

## M210



- 1201 2,5x50-3x75-4x100-5,5x125 6,5x150-8x200 mm
- 1201N 4x30 mm
- 1202 PH0x60-PH1x80-PH2x100 PH3x150 mm
- 1202N PH1X30 mm
- 1207TX T6-T7-T8-T9-T10 T15-T20-T25-T27 T30-T40-T45
- 1253

024500210 1,8 kg

€ 172,50 € 99,50

## M128

12"



- 720 10-11-12-13-14-15-16-17-18-19-21-22-24 27-30-32 mm
- 720L 11-12-13-14-15-16-17-18-19-21-22-24-27 30-32 mm
- 720TX T30-T40-T45-T50-T55
- 720ME 5-6-8-10-12-14-17-19 mm
- 720LC 17-19-21 mm
- 720/21 125 mm
- 720/25

**Novità**

024500128 8,9 kg

€ 787,00 € 454,00

## M195

**Novità**

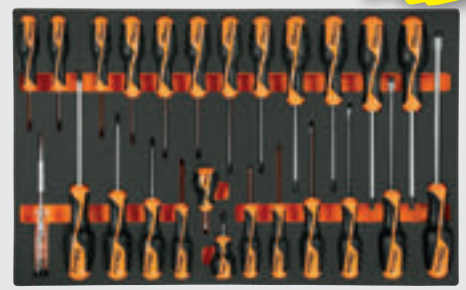

- 1260 2,5x50-3x75-4x100-5,5x125-6,5x150-8x200 mm
- 1260N 4x30 mm
- ⊕ 1262 PH0x60-PH1x80-PH2x100-PH3x150 mm
- ⊕ 1262 PH1X30 mm
- 1267TX T6-T7-T8-T9-T10-T15-T20-T25-T27-T30-T40-T45
- 1253 3,5x100 mm

024500195 2,3 kg

€ 247,00 € 142,00

## M230



- 30 Ø 2-3-4 mm
- 31 Ø 2-3-4-5-6-8 mm
- 32 Ø 4 mm
- 34 150 mm
- 35 200-250 mm
- 36 125 mm
- 1370 500 g
- 1390 Ø 35 mm
- 1692 3 m
- 1712
- 1719BMA/Q 200 mm
- ▲ 1719BMA/T 200 mm
- 1719BMA/P 200 mm
- ▶ 1719BMA/M 200 mm
- 1719BMA/R 200 mm
- 1737
- 1771 18 mm

024500230 3,2 kg

€ 327,00 € 189,00





### T10

17

42 6-7-8-10-11-12-13-14-16  
17-18-19-21-22-24-27-30 mm

024240010 2,7 kg

€ 226,00 € 131,00

### T13 *Novità*

11

42SLIM 8-10-11-12-13-14  
15-16-17-18-19 mm

024240013 1,5 kg

€ 124,00 € 71,50

### T15

16

42 6-7-8-9-10-11-12-13-14  
15-16-17-18-19-20-21 mm

024240015 1,5 kg

€ 172,00 € 100,00

### T16

5

42 22-24-27-30-32

024240016 2,1 kg

€ 122,50 € 71,00

### T31

27

31 Ø 2-3-4-5-6 mm  
32 Ø 4 mm  
55 6x7-8x9-10x11-12x13-14x15  
16x17-18x19-20x22-21x23  
24x26-27x29-30x32 mm  
○ 96N/SC9 1,5÷10 mm

024240031 3 kg

€ 180,50 € 104,00

### T40

7

90 6x7-8x9-10x11-12x13  
14x15-16x17-18x19 mm

024240040 810 g

€ 86,00 € 50,00

### T45

12

142 8-9-10-11-12-13-14  
15-16-17-18-19 mm

024240045 1,3 kg

€ 254,00 € 147,50

### T50

11

○ 96T 2-2,5-3-3,5-4-4,5  
5-6-7-8-10 mm

024240050 1,3 kg

€ 143,00 € 82,50

### T55

6

○ 97TTX T10-T15-T20 T25-  
T27-T30

024240055 330 g

€ 80,50 € 46,50

### T63

8

○ 952 7-8-10-12-13-14  
17-19 mm

024240063 3,8 kg

€ 277,00 € 160,00

### T83

24

○ 920A 10-11-12  
13-14-15-16-17-18  
19-20-21-22-23-24  
26-27-30-32 mm  
920/21 125 mm  
920/22 255 mm  
920/25  
920/42 305 mm  
920/55 Ⓟ 275 mm

024240083 3,6 kg

€ 282,00 € 162,50

### T85

81

- 861LP 0,5x3-0,6x4,5-0,8x5,5-1x5,5  
1,2x6,5-1,2x8-1,6x8 mm
- 861PE 2-2,5-3-4-5-6-8-10 mm
- 861PH PH0 - PH1 - PH2 - PH3
- 861PZ PZ1 - PZ2 - PZ3
- 861TX T6-T7-T8-T9-T10-T15-T20-T25-T27-T30-T40
- 861RTX T9-T10-T15-T20-T25-T27-T30-T40
- 861TRW 1-2-3-4-5-6 mm
- 861TQS 0-1-2-3-4-5-6-8 mm
- 861SP 4-6-8-10-12 mm
- 851SR 230 mm
- 900 4-4,5-5-5,5-6-7-8-9-10-11-12-13-14 mm

900/21 150 mm 900/25 41 mm  
900BG/30 176 mm 900/42 115 mm  
Ⓟ 900/55 125 mm 194 1/4x5/16

024240085 1 kg

€ 283,00 € 163,00

### T91

25

- 900 4-4,5-5-5,5-6  
7-8-9-10-11-12  
13-14 mm
- 900ME 2,5-3-4-5  
6-8 mm
- 900/20 50 mm
- 900/21 150 mm
- 900/25
- 900BG/30 176 mm
- 900/42 115 mm
- Ⓟ 900/55 125 mm

024240091 560 g

€ 188,50 € 109,50

### T92

22

- 910A 6-7-8-9-10-11  
12-13-14-15-16-17-18  
19-20-21-22 mm
- 910/21 125 mm
- 910/22 250 mm
- 910/25
- 910/42 210 mm
- Ⓟ 910/55 200 mm

024240092 1,5 kg

€ 224,50 € 130,00



**T103** 12" 14"



- 900L 6-7-8-9-10-11-12 mm
- 920AL 13-14-16-17-18-19  
21-22-24-27 mm

024240103 1,1 kg  
~~€ 251,00~~ € 145,00

**T131**



- 1084BM 160 mm
- 1150BM 180 mm
- 1166BM 160 mm

024240131 750 g  
~~€ 91,50~~ € 53,00

**T145**



- 1032 180 mm
- 1034 170 mm
- 1036 175 mm
- 1038 175 mm

024240145 640 g  
~~€ 102,50~~ € 59,00

**T153**



- 1048 250 mm
- 1052 240 mm

024240153 1,1 kg  
~~€ 62,50~~ € 36,00

**T199**



**GRIP**

- 1260 2,5x50 - 3x75 - 3,5x100  
4x125 - 5,5x100 - 5,5x150-6,5x150 mm

024240199 490 g  
~~€ 47,00~~ € 27,00

**T202**



**GRIP**

- 1262 PH0x60 - PH0x100 - PH1x80  
PH1x120 - PH2x100 - PH2x150 mm

024240202 490 g  
~~€ 43,50~~ € 25,00

**T205**



**GRIP**

- 1267TX  
T6-T7-T8-T9-T10-T15-T20

024240205 460 g  
~~€ 63,00~~ € 36,00

**T210**



**Beta EASY**  
PRACTICAL LINE

- 1201 2,5x50-3x75-3,5x100-4x125  
5,5x100-5,5x150 6,5x150 mm

024240210 490 g  
~~€ 33,50~~ € 19,30

**T212**



**Beta EASY**  
PRACTICAL LINE

- 1202 PH0x60-PH1x80-PH1x120  
PH2x100-PH2x150-PH3x150 mm

024240212 490 g  
~~€ 36,00~~ € 20,80

**T215**



**Beta EASY**  
PRACTICAL LINE

- 1207TX  
T6-T7-T8-T9-T10-T15-T20

024240215 410 g  
~~€ 47,00~~ € 27,00

**T234**



- 35 100-200 mm
- 1370 300 g
- 1390 ø 35 mm

024240234 1,3 kg  
~~€ 77,50~~ € 45,00

**T236**



- 1719BMA/Q 200 mm
- ▲ 1719BMA/T 200 mm
- 1719BMA/P 200 mm
- ▶ 1719BMA/M 200 mm
- 1719BMA/R 200 mm

024240236 870 g  
~~€ 77,00~~ € 44,50

**T239**



- 31BM Ø 2-3-4-5-6-8 mm
- 32 ø 4 mm

024240239 850 g  
~~€ 105,00~~ € 61,00





## C45

### COMBINAZIONE COMPOSTA DA:

- Modulo fisso con 7 cassetti 566x406 mm
- Modulo fisso di servizio
- Cassettiera mobile con 7 cassetti 532x406 mm
- Armadio a 2 ante
- 3 pannelli forati portautensili
- 3 pensili a muro
- 3 staffe per parete tipo largo
- 1 staffa per parete tipo stretto

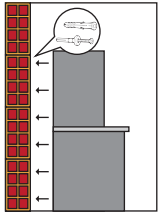

## C45/X

### Combinazione arredo officina C45/X

- Piano di lavoro in MDF rivestito in acciaio inox (C45PX/3-2,0MT)

045000010 294 kg  
 € 3.420,00 € 1.795,00



## C45/W

### Combinazione arredo officina C45/W

- Piano di lavoro in legno multistrato (C45PW/3-2,0MT)

045000020 260 kg  
 € 3.040,00 € 1.750,00

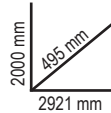

## C45/B

### COMBINAZIONE COMPOSTA DA:

- Modulo fisso con 5 cassetti 566x406 mm
- Modulo fisso con 2 antine
- Armadio a 1 anta
- 2 pensili a muro
- 2 pannelli forati portautensili
- 2 staffe per parete tipo largo
- 1 staffa per parete tipo stretto

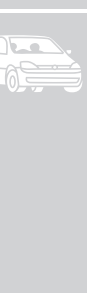
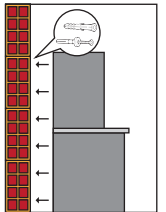

## C45/BX

### Combinazione arredo officina C45/BX

- Piano di lavoro in MDF rivestito in acciaio inox (C45PX/2-1,3MT)

045000043 275 kg  
 € 1.935,00 € 1.115,00



## C45/BW

### Combinazione arredo officina C45/BW

- Piano di lavoro in legno multistrato (C45PW/2-1,3MT)

045000053 260 kg  
 € 1.855,00 € 1.060,00

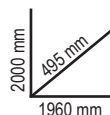



# 5945VUM

Assortimento di 231 utensili per impiego universale

N. pezzi/Descrizione	Beta N.	TR
21 chiavi combinate 6-7-8-9-10-11-12-13-14-15-16-17-18-19-20-21-22-24-27-30-32 mm	42	MM10
9 chiavi maschio esagonale piegate con estremità sferica ○ 1,5-2-2,5-3-4-5-6-8-10 mm	96BPC/SC9	MM10
8 chiavi maschio esagonale con impugnatura ○ 2-2,5-3-4-5-6-7-8 mm	96T	MM61
1 martello tipo tedesco 300 g	1370	MM61
1 mazzuola con battenti in materiale plastico Ø 35	1390	MM61
2 scalpelli piatti nervati 100-200 mm	35	MM61
5 lime a taglio mezzodolce 200 mm	1719BMA8/S5	MM61
1 bussola portainseri ○ 1/4 - □ 1/4	895/1	MM105
1 bussola portainseri ○ 1/4 - □ 3/8	895/3	MM105
1 bussola portainseri ○ 5/16 - □ 1/2	895/6	MM105
13 chiavi a bussola esagonali 1/4" ○ 4-4,5-5-5,5-6-7-8-9-10-11-12-13-14 mm	900	MM105
9 chiavi a bussola a mano lunghe bocca esagonale ○ 5-6-7-8-9-10-11-12-13 mm	900L	MM105
5 chiavi a bussola maschio esagonale 1/4" ○ 3-4-5-6-7 mm	900ME	MM105
4 chiavi a bussola a giravite per viti con intaglio ● 0,8x4-1x5,5x1,2x6,5-1,2x8 mm	900LP	MM105
4 chiavi a bussola a giravite per viti con impronta a croce Phillips® PH1-PH2-PH3-PH4	900PH	MM105
7 chiavi a bussola a giravite maschio per viti con impronta Torx® ○ T10-T15-T20-T25-T27-T30-T40	900TX	MM105
1 raccordo con attacco quadro □ 1/4 - ■ 3/8	900/16	MM105
1 prolunga - 1/4" 50 mm	900/20	MM105
1 prolunga - 1/4" 100 mm	900/20L	MM105
1 prolunga - 1/4" 150 mm	900/21	MM105
1 snodo 1/4"	900/25	MM105
1 quadro con impugnatura 1/4" 176 mm	900BG/30	MM105
1 quadro scorrevole 1/4" 115 mm	900/42	MM105
1 cricchetto reversibile 1/4" ● 125 mm	900/55	MM105
17 chiavi a bussola esagonali 3/8" ○ 6-7-8-9-10-11-12-13-14-15-16-17-18-19-20-21-22 mm	910A	MM105
1 raccordo con attacco quadro □ 3/8 - ■ 1/4	910/15	MM105
1 raccordo quadro maschio 1/2" e femmina 3/8" □ 3/8 - ■ 1/2	910/16	MM105
1 prolunga - 3/8" 125 mm	910/21	MM105
1 prolunga - 3/8" 250	910/22	MM105
1 snodo 3/8"	910/25	MM105
1 quadro maschio 3/8" con spina scorrevole 210 mm	910/42	MM105
1 cricchetto reversibile 3/8" ● 200 mm	910/55	MM105
21 chiavi a bussola esagonali 1/2" ○ 8-10-11-12-13-14-15-16-17-18-19-20-21-22-23-24-26-27-28-30-32 mm	920A	MM105
1 raccordo con attacco quadro □ 1/2 - ■ 3/8	920/15	MM105
1 snodo 1/2"	920/25	MM105
1 prolunga angolare - 1/2" 125 mm	920AN	MM105
1 prolunga angolare - 1/2" 250 mm	920AN	MM105
1 quadro maschio 1/2" con spina scorrevole 305 mm	920/42	MM105
1 cricchetto reversibile 1/2" ● 275 mm	920/55	MM105
3 chiavi a bussola per candele 3/8" ○ 16 mm (5/8")-17,8 (11/16")-20,8 (13/16")	956E	MM105
5 chiavi maschio con impugnatura per viti con impronta Torx® ○ T10-T15-T20-T25-T30	97TTX	MM140
1 tronchesi a grande effetto taglienti diagonali † 160 mm	1084BM	MM140
1 pinza universale ■ 180 mm	1150BM	MM140
1 pinza a becchi mezzotondi dritti ● 160 mm	1166BM	MM140
1 pinze becchi dritti per anelli elastici, per fori ○ 19÷60 mm	1032	MM140
1 pinze becchi piegati per anelli elastici, per fori ○ 19÷60 mm	1034	MM140
1 pinze becchi dritti per anelli elastici, per alberi ● 19÷60 mm	1036	MM140
1 pinze becchi piegati per anelli elastici, per alberi ● 19÷60 mm	1038	MM140
1 pinze regolabili cerniera chiusa 250 mm	1048	MM140



consigliato in abbinamento con il sistema di arredo C45



MM10

30

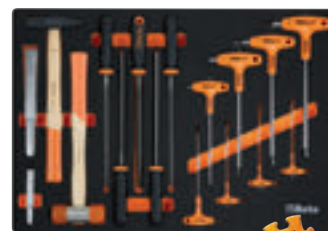

MM61

17



MM105

107

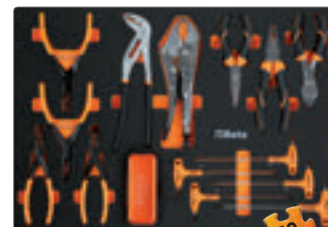

MM140

52



MM210

25

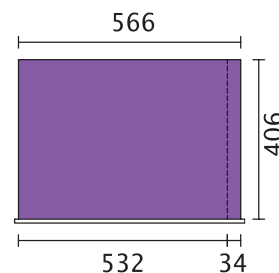

## N. pezzi/Descrizione

N. pezzi/Descrizione	Beta N.	TR
1 pinza autobloccante 240 mm	1052	MM140
38 cassetta microgiravite 36 pezzi + 2 accessori	1256/C36-2	MM140
6 giravite lama piatta ● 04x2,5x50-0,5x3x75-0,8x4x100-1,0x5,5x125-1,2x6,5x150-1,2x8x200 mm	1201	MM210
1 giravite per viti a testa con intaglio ● 0,8x4x30 mm	1201N	MM210
4 giravite Phillips® PH0x60-PH1x80PH2x100PH3x150 mm	1202	MM210
1 giravite Phillips® PH1x30 mm	1202N	MM210
12 chiavi maschio con impugnatura per viti con impronta Torx® ○ T06-T07-T08-T09-T10-T15-T20-T25-T27-T30-T40-T45	1207TX	MM210
1 giravite cercafase ● 0,5x3,5x100 mm	1253	MM210

059450001 19,6 kg  
~~€ 2.225,00~~ € 1.285,00

# 9562P2

Tappeto con logo BETA dimensioni 200x80 cm

- Particolarmente indicato per utilizzi con arredo officina RSC55, C45 o come tappeto sottomoto
- Protegge il suolo da perdite di olio, benzina e rispetta l'ambiente
- Facile da pulire, fondo gommato ed antiscivolo

095620400 1,6 kg

~~€ 133,00~~ € 77,50





## C56B

### Banco da lavoro con piano in legno

Caratteristiche principali:

- Piano di lavoro in legno multistrato con fori per la collocazione di una morsa 1599F/125 (da ordinare separatamente)
- Struttura in acciaio con 4 gambe di sostegno
- Capacità di carico statico: 600 kg
- Ripiano inferiore portaoggetti con capacità di carico 150 kg uniformemente distribuiti
- Predisposizione per il fissaggio al pavimento



930 mm

62 kg



720 mm

2000 mm

C56B

056000401

056000402

056000403

€ 498,00

€ 285,00

## C58B

### Banco da lavoro con piano in legno

Caratteristiche principali:

- Piano di lavoro in legno multistrato con fori per la collocazione di una morsa 1599F/125 (da ordinare separatamente)
- Struttura in acciaio con 4 gambe di sostegno
- Capacità di carico statico: 800 kg
- Ripiano inferiore portaoggetti con capacità di carico 150 kg uniformemente distribuiti
- Predisposizione per il fissaggio al pavimento

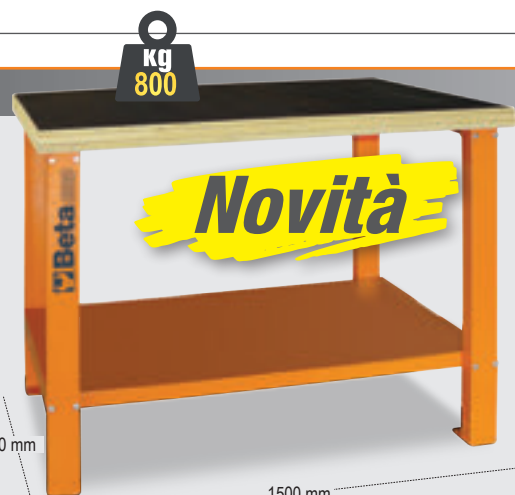

930 mm

59 kg



720 mm

1500 mm

C58B

058000401

058000402

058000403

€ 460,00

€ 265,00

## C59A

### Banco con 1 cassetiera da 6 cassetti

- 6 cassetti 588x367 mm, montati su guide telescopiche a sfera
- Ripiano in legno multistrato con fori per la collocazione di una morsa 1599F/125 (da ordinare separatamente)
- Piano dei cassetti protetto da tappetini di gomma espansa
- Cassettiere predisposte per l'inserimento di termoformati
- Frontalino dei cassetti in nylon ad alta resistenza
- Serratura di sicurezza centralizzata frontale
- Ripiano inferiore portaoggetti
- Predisposizione per portacarta (2400S-R/PC) e portafilaconi (2400S/PF) da ordinare separatamente



900 mm

700 mm

2000 mm

n°	h	max
4	70 mm	25 kg
1	140 mm	30 kg
1	280 mm	35 kg

115 kg



C59A

059000001

059000021

059000041

€ 1.335,00

€ 759,00



## C56

### Banco da lavoro

- Piano di lavoro in lamiera verniciata con bordo perimetrale
- Struttura in acciaio con 6 gambe di sostegno
- Due cassetti dotati di serratura
- Predisposizione per il fissaggio al pavimento

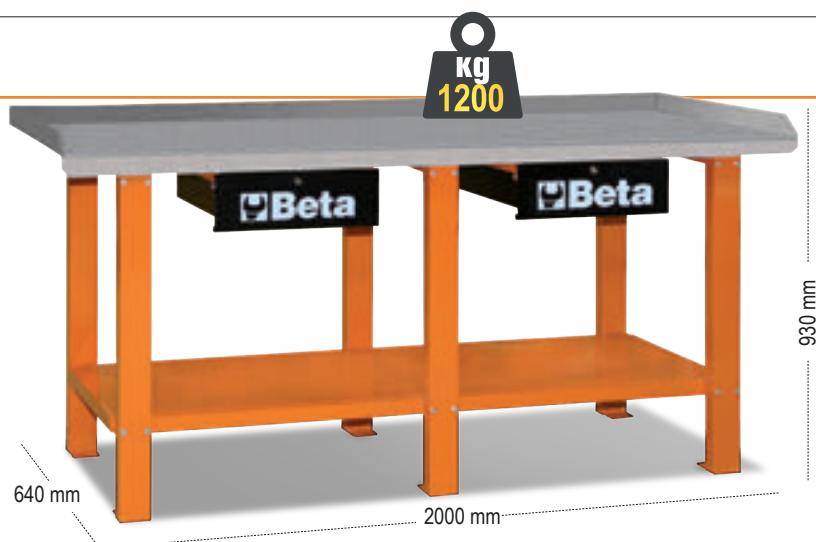

82 kg



C56	056000201	056000202	056000203	<del>€ 765,00</del>	€ 434,00
-----	-----------	-----------	-----------	---------------------	----------

## C56PO

### Banco da lavoro pieghevole

- Piano di lavoro spessore 30 mm in MDF e lamiera zincata utilizzabile da entrambi i lati.
- Maniglia con protezione in gomma per un agevole trasporto.
- Piedini con copertura anti-scivolamento.

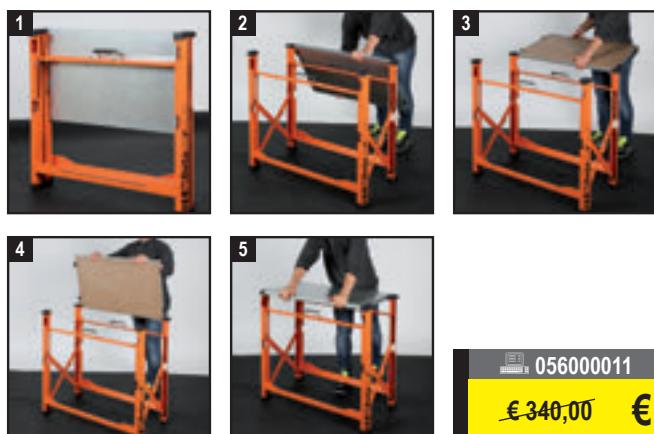

056000011 25 kg

~~€ 340,00~~ € 199,00

## C51

### Carrello

- 3 ripiani ricoperti in gomma millerighe antiscivolo
- Doppia possibilità di fissaggio del ripiano centrale
- Quattro ruote Ø 100 mm: 2 fisse e 2 girevoli (una con freno)



21 kg



C51	051000001	051000002	051000003	<del>€ 214,00</del>	€ 121,00
-----	-----------	-----------	-----------	---------------------	----------





## C27S

**Carrello portautensili richiudibile per interventi esterni, vuoto**

- Struttura in lamiera
- Carrello richiudibile con colonnine ribaltabili per permettere un agevole trasporto
- 2 cassetti 588x277 mm montati su guide telescopiche che permettono l'apertura in due sensi
- Ampio vano portaoggetti inferiore 588x277x220 mm
- 2 ruote fisse Ø 160 mm e 2 ruote piroettanti con freno Ø 100 mm
- Piano di lavoro termoplastico con 6 vaschette portaminuterie integrate
- Chiusura centralizzata
- Predisposizione per l'alloggiamento di separatori per cassetto e termoformati portautensili MC



n°	h	max
2	70 mm	20 kg



20 kg

C27S	027000201	027000202	027000203	€ 550,00	€ 313,00
------	-----------	-----------	-----------	----------	----------

## 5927VU/M



**Assortimento di 108 utensili in termoformato morbido per carrello C27S**

per cassetto: 588x277 mm



MC10



MC20

059270021	8,3 kg
€ 829,00	€ 477,00

## C41H

**Trolley portautensili a 2 moduli sovrapponibili**

- Struttura in lamiera e in materiale plastico: grande robustezza e peso ridotto
- 2 moduli separabili: 1 cestello superiore, 1 modulo con 2 cassetti altezza 95 mm, 1 cassetta estraibile in materiale plastico altezza 66 mm e 1 cassetto altezza 295 mm
- Ruote di grosso diametro 160 mm integrate nella struttura per facilitare il trasporto anche su gradini
- Serratura centralizzata laterale per la chiusura dei cassetti del modulo inferiore
- Cassetti montati su guide telescopiche a sfera con doppio gancio di chiusura
- Impugnatura con manico telescopico in alluminio
- Portaminuterie integrato
- Cassetto inferiore con doppia guida telescopica



C41H W RAL 9016

C41H Y RAL 1023

C41H R RAL 3000

C41H V RAL 6016

C41H B RAL 5002

C41H G RAL 7016

C41H N RAL 9005



21 kg

C41H	041000002	041000021	041000012	041000008	€ 465,00
	041000024	041000006	041000010	041000005	€ 259,00



## Cestelli in materiale plastico con contenitori e vaschette portaminuterie, vuoti

- 3 vaschette portaminuterie integrate nel coperchio con divisori regolabili
- 1 contenitore interno con divisori regolabili
- Capacità di carico: 30 kg

### CP15L



558x277x270 mm



021150202 2,5 kg

€ 50,00 € 28,50

### CP15



445x240x250 mm

021150201 2 kg

€ 37,50 € 21,50

### C14

#### Trolley portautensili in polipropilene con 4 cassetti, vuoto

- Struttura in polipropilene a iniezione che garantisce elevata resistenza agli urti
- 4 robuste ruote posteriori
- 3 vaschette porta minuteria incluse
- Targhetta identificativa portanome
- Predisposizione per la chiusura con lucchetto TSA
- Ruote di grosso diametro (ø 160 mm)

Vassoio superiore removibile



580x380x455 mm

La parte anteriore, protetta dal coperchio frontale, ospita 4 cassetti 470x255 mm estraibili:

- 1 cassetto altezza 30 mm
- 2 cassetti altezza 60 mm
- 1 cassetto altezza 90 mm



La serratura centralizzata frontale consente di chiudere contemporaneamente i due coperchi, quello superiore e quello frontale



Due maniglie laterali

021140000 10 kg

€ 670,00 € 387,00

### 5914VU/M

Assortimento di 109 utensili per trolley C14, in termoformato morbido



MC T1



MC T2



MC T3

- per l'utilizzo in abbinamento con il trolley C14, occorre rimuovere il pannello portautensili superiore

• solo assortimento

059140111 8,5 kg

€ 907,00 € 520,00





## C20L

Cestello estendibile a 5 scomparti in lamiera, vuoto



550x200x210 mm

021200002 5,4 kg  
~~€ 66,50~~ € 38,00

## C16

Cestello in materiale plastico con vano portaoggetti interno, vuoto



500x260x260 mm

021160000 2,5 kg  
~~€ 83,50~~ € 48,00

## C20TSS

Cestello estendibile a 5 scomparti in acciaio inossidabile AISI 304 può essere utilizzato in ambienti critici, ovvero zone e aree in cui non è ammesso il livello minimo di contaminazione, resiste alla ruggine e ai principali acidi ed è sterilizzabile in autoclave a 121 °C.



450x200x210 mm

021203001 4 kg  
~~€ 241,00~~ € 139,50

## 2080/V6

Valigia organizer con 6 vaschette asportabili e divisori regolabili

Vaschette portaminuterie asportabili, richiudibili e trasparenti per un' immediata riconoscibilità del contenuto.



4385x320x60 mm

020800060 1,2 kg  
~~€ 30,50~~ € 17,50

## CP17

Cestello portautensili in acciaio inox e materiale plastico con contenitore asportabile, vuoto



500x200x220 mm



021170500 2,5 kg  
~~€ 69,50~~ € 40,00

## 2080/V12

Valigia organizer con 12 vaschette asportabili

Vaschette portaminuterie asportabili, richiudibili e trasparenti per un' immediata riconoscibilità del contenuto.



300x330x145 mm

020800000 1,8 kg  
~~€ 46,50~~ € 26,90



## Borse portautensili in tessuto tecnico *leggere e altamente resistenti* per trasportare in totale sicurezza e comodità i tuoi utensili



### C5

Zaino, vuoto

- Pannello portautensili interno removibile
- 6 tasche esterne e 2 tasche interne
- Base in materiale plastico resistente all'acqua
- Doppio laccetto di sicurezza per fissare lo zaino sulle spalle
- Schienale ergonomico imbottito



500x400x180 mm

021050000 2,5 kg

€ 123,00 € 69,50

### C6T

Zaino con ruote, vuoto

- Manico telescopico di trasporto
- Ruote integrate nella struttura con copertura anti-polvere per l'impiego come zaino
- 2 pannelli portautensili removibili
- Tasca per PC interna e 5 tasche esterne
- Base in materiale plastico resistente all'acqua



480x370x220 mm

021060010 4,5 kg

€ 175,00 € 101,00

### C7

Borsa, vuota

- 2 pannelli interni portautensili removibili
- 2 tasche esterne frontali
- Fondo interno in materiale plastico con divisori removibili



440x370x170 mm

021070000 3,5 kg

€ 183,00 € 105,00

### C11

Cestello, vuoto

- Base rigida in materiale plastico resistente all'acqua
- Elastici e tasche portautensili sia interne che esterne
- Buste portadocumenti integrate nel doppiofondo del coperchio



400x240x220 mm

021110000 2 kg

€ 73,50 € 42,00

### C8

Trolley, vuoto

- Manico telescopico di trasporto
- 2 pannelli interni portautensili removibili
- Tasca porta PC interna e 2 tasche esterne frontali
- Predisposizione per l'alloggiamento del cestello C10S



470x370x280 mm

021080000 4 kg

€ 206,00 € 117,50

Cestello, vuoto

- Struttura rigida
- Doppio fondo
- Manico inclinabile per facilitare l'accesso agli utensili
- Elastici portautensili e tasche sia interne che esterne
- Fodero di copertura
- Vaschetta portaminuterie inclusa nel doppio fondo
- Predisposizione per essere utilizzata con il trolley C8



### C10S

420x220x250 mm

021100001 2,3 kg

€ 97,00 € 55,00

### C10

520x220x250 mm

021100000 3,3 kg

€ 123,00 € 70,50



## 2029/VV

**Valigia portautensili in polipropilene ad alto spessore, profilata in alluminio, vuota**

- 2 pannelli portautensili
- Fornita di tracolla

≡ 490x380x230 mm

020290000 6,1 kg

€ 276,00 € 159,00



## 2038/TV

**Trolley portautensili in polipropilene ad alto spessore, vuoto**

- Estremamente resistente agli urti
- Profilo di tenuta in alluminio
- Maniglione telescopico e grandi ruote con cuscinetti a sfera
- Fondo capiente
- Tasca porta documenti
- 3 cassettoni portaminuterie

2 pannelli portautensili removibili

≡ 430x500x340 mm



2 maniglie (1 laterale ergonomiche rivestite in gomma)



2 serrature omologate TSA con chiave



## 2028/VV

**Valigia portautensili in polipropilene, vuota**

- 2 pannelli portautensili
- Fondo interno con divisori removibili
- Doppia chiusura con combinazione



020280010 4,5 kg

€ 194,00 € 113,00

≡ 470x185x410 mm





**42/SP15**

**Novità**

Serie di 15 chiavi combinate

- Comodo e pratico supporto incluso



**NUOVA  
FORMA**



6-7-8-9-10-11-12-13  
14-15-16-17-19-22-24 mm

000421078 2,1 kg

€ 154,00 € 87,50

**42/SC9**

**Novità**

Serie di 9 chiavi combinate

- Supporto compatto, pratico e facile da trasportare
- Identificazione rapida della misura della chiave
- Bloccaggio sicuro della chiave nel supporto



8-10-11-12-13-14-15-17-19 mm



**NUOVA  
FORMA**

000421087 890 g

€ 90,00 € 51,50

**42INOX/SC9**

Serie di 9 chiavi combinate  
in acciaio inossidabile  
con supporto compatto



8-10-11-12-13-14-15-17-19 mm



000420387 812 g

€ 155,00 € 88,50



**UNA NUOVA FORMA**

La nostra storica chiave 42 ha una nuova forma. Elegante e snella, alleggerita nelle linee e più leggera al tatto, con spessori delle teste ridotti al minimo possibile per intervenire correttamente in ogni spazio. La **forza**, la **resistenza** e la **rapidità** d'uso della chiave Beta raggiungono valori ancora superiori per offrire la miglior chiave possibile alle mani degli utilizzatori. Il **processo produttivo** si svolge nei nostri stabilimenti di Sovico e Sulmona, avvalendosi delle tecnologie più avanzate in termini di automazione e degli operatori più preparati in termini di esperienza.

**Rapidità**

Angolo di 15° rispetto all'asse per ridurre l'angolo di ripresa

**Resistenza**

Grande resistenza: nel caso di uso improprio la chiave inizia a deformarsi, non si spezza in modo improvviso

**Omogeneità**

Lo stampaggio parte da un semilavorato a sezione tonda che garantisce alle fibre una distribuzione omogenea escludendo la formazioni di pericolose tensioni interne

**Accessibilità**

Spessori ridotti per migliorare l'accessibilità

**Protezione**

La nichel-cromatura garantisce nel tempo la protezione dagli agenti esterni e supera le impegnative prove di aderenza della norma ISO 2819

**Forza**

Valori di coppia più che doppi rispetto ai requisiti della norma ISO 1711

**Ottimizzazione**

La lunghezza della chiave, superiore alla maggior parte dei concorrenti, permette di ottenere coppie elevate con sforzo minore.

**Ergonomia**

L'occhio poligonale è inclinato di 15° per proteggere la mano. La forma è ottenuta da stampo, non piegata successivamente.



**MADE IN ITALY**





## 141/B9

**Novità**

Serie di 9 chiavi combinate a cricchetto diritte, in busta di tela  
 ☎ 8-10-11-12-13-14-15-17-19 mm



001410069 900 g  
~~€ 161,50~~ € 93,00

## 42SLIM/B8I

**Novità**

Serie di 8 chiavi combinate, in busta di tela  
 Testa ribassata all'altezza del gambo



☎ 10-11-12-13  
 14-15-17-19 mm

000420468 700 g  
~~€ 87,50~~ € 50,50



## 142/SC9I

Serie di 9 chiavi combinate a cricchetto reversibile con supporto compatto  
 ☎ 8-10-11-12-13-14-15-17-19 mm



001420087 1,2 kg  
~~€ 180,00~~ € 103,00

## 142SN/SC9

Serie di 9 chiavi combinate a cricchetto snodate con supporto compatto  
 ☎ 8-10-11-12-13-14-15-17-19 mm



001420259 1,3 kg  
~~€ 217,00~~ € 124,50

## 192/S2

Serie di 2 chiavi poligonali a cricchetto reversibile

**8 misure in 2 chiavi**



001920070 500 g  
~~€ 55,00~~ € 31,80

## 55/SP7

Serie di 7 chiavi a forchetta doppie comodo e pratico supporto incluso



☎ 6x7-8x9-10x11-12x13  
 14x15-16x17-18x19 mm

000550167 920 g  
~~€ 43,00~~ € 25,00



# 111

## Chiavi regolabili a rullino cromate con scala graduata

- Apertura della ganasce mobile con rotazione destrorsa del rullino
- Scala millimetrata e in pollici



	L mm	A max	g			
111/100	100	15 mm	60	001110010	<del>€ 19,70</del>	€ 11,40
111/150	150	24 mm	165	001110015	<del>€ 20,70</del>	€ 12,00
111/200	200	28 mm	325	001110020	<del>€ 24,70</del>	€ 14,30
111/250	250	34 mm	505	001110025	<del>€ 31,00</del>	€ 17,80
111/300	300	35 mm	790	001110030	<del>€ 40,50</del>	€ 23,30
111/450	450	54 mm	2043	001110045	<del>€ 132,00</del>	€ 76,00
111/600	600	62 mm	3300	001110060	<del>€ 182,00</del>	€ 105,00

*Doppia lettura mm-pollici*

# 90/S7

## Serie di 7 chiavi poligonali doppie curve

- 6x7-8x9-10x11-12x13-14x15-16x17-18x19 mm



000900163 800 g  
~~€ 76,50~~ € 44,00

# 96T/S5P

## Serie di 5 chiavi maschio esagonale piegate con impugnatura

- 2,5-3-4-5-6 mm



000960946 300 g  
~~€ 52,00~~ € 29,50

# 97TTX/S6

## Serie di 6 chiavi maschio piegate per viti con impronta Torx® con impugnatura

- T10-T15-T20-T25-T30-T40



000970791 400 g  
~~€ 74,50~~ € 40,00

# 951/S6

## Serie di 6 chiavi a T con 3 estremità maschio esagonale cromate

- 2,5-3-4-5-6-8 mm



009510687 600 g  
~~€ 105,50~~ € 60,00

# 952/D7

## Serie di 7 chiavi a T con bussola esagonale snodata

- 7-8-10-12-13-14-17 mm

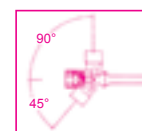

009520079 2,5 kg  
~~€ 204,00~~ € 117,00





### 96/SC9

Serie di 9 chiavi maschio esagonale piegate



Ø mm	L mm
1,5	42
2	48
2,5	59
3	62
4	70
5	81
6	92
8	102
10	116

000960374 300 g  
~~€ 17,30~~ € 9,70

### 96BP-CL/SC9

Serie di 9 chiavi maschio esagonale piegate colorate con un'estremità sferica

Modello extra lungo +30%



Ø mm	L mm
1,5	91
2	100
2,5	113
3	130
4	142
5	163
6	185
8	205
10	231



**Novità**

000961619 440 g  
~~€ 44,00~~ € 24,00

### 96BPC/SC9

Serie di 9 chiavi maschio esagonale piegate con un'estremità sferica



Ø mm	L mm
1,5	79
2	85
2,5	89
3	100
4	110
5	129
6	152
8	173
10	194

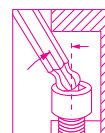

000960354 400 g  
~~€ 36,50~~ € 18,00

### 97BTXL/SC8

Serie di 8 chiavi maschio piegate con un'estremità sferica, modello lungo per viti con impronta Torx®



Ø mm	L mm
T9	83
T10	89
T15	103
T20	114
T25	130
T27	145
T30	166
T40	183



Modello extra lungo +25%

000970364 240 g  
~~€ 75,00~~ € 40,00

### 97BTX/SC8

Serie di 8 chiavi maschio piegate con un'estremità sferica per viti con impronta Torx®



Ø mm	L mm
T9	65
T10	74
T15	84
T20	96
T25	98
T27	109
T30	123
T40	136

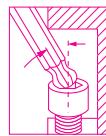

000970164 170 g  
~~€ 65,00~~ € 35,00

### 96LBP/SC9

Serie di 9 chiavi maschio esagonale piegate con un'estremità sferica

Modello extra lungo +30%



Ø mm	L mm
1,5	91
2	100
2,5	113
3	130
4	142
5	163
6	185
8	205
10	231

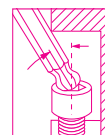

000961354 500 g  
~~€ 42,00~~ € 23,00

## 1297TX/LS5

**Novità**

Serie di 5 giraviti lunghi Beta Max per viti con impronta Torx®  
 ○ T15-T20-T25-T30-T45



012970325 620 g  
~~€ 68,50~~ € 39,50

Ø	L (mm)	L1 (mm)
T15	210	319
T20	210	319
T25	210	319
T30	210	330
T45	210	342

## 944BX/D6

Serie di 6 chiavi a bussola esagonale profonda bimatereale tipo lungo



009440056 1 kg  
~~€ 102,00~~ € 59,00

○ 5-6-7-8-10-13 mm



Beta max  
 MAXIMUM PERFORMANCE

## 1293/D8

Serie di 8 giravite



012930403 730 g  
~~€ 66,50~~ € 38,00

1290 ○ 3x75-4x100-5,5x150-6,5x150 mm  
 1292 ⊕ PH0x60-PH1x80- PH2x100 mm



Beta max  
 MAXIMUM PERFORMANCE

## 1203/D8P

Serie di 8 giravite

1201 ○ 2,5x50-3x75-4x100-5,5x100-6,5x150 mm  
 1202 ⊕ PH0x60-PH1x80- PH2x100 mm



012030018 640 g  
~~€ 34,00~~ € 19,50

## 1203/D10N

Serie di 10 giravite

1201 ○ 2,5x50-3x75-4x100-5,5x150-6,5x150 mm  
 1202 ⊕ PH0x60-PH1x80- PH2x100 mm  
 1201N ○ 4x30 mm  
 1202N ⊕ PH1x30 mm

012030019 740 g  
~~€ 43,50~~ € 24,80

## 1207TX/D7

Serie di 7 giravite

1207TX ○ T6-T8-T10-T15-T20-T25-T30

012070207 560 g  
~~€ 44,50~~ € 24,70

## 1263/D8

Serie di 8 giravite

1260 ○ 2,5x50-3x75-4x100- 5,5x125-6,5x150 mm  
 1262 ⊕ PH0x60-PH1x80- PH2x100 mm

012630008 600 g  
~~€ 48,00~~ € 27,50

## 1263/D10

Serie di 10 giravite

1260 ○ 3x75-3,5x100-4x125-5,5x150-6,5x150 mm  
 1262 ⊕ PH0x60- PH1x8- PH2x100 mm  
 1260N ○ 4x30 mm  
 1262N ⊕ PH1x30 mm

012630010 690 g  
~~€ 61,50~~ € 35,00

## 1267TX/D7

Serie di 7 giravite

1267TX ○ T6-T8-T10-T15-T20-T25-T30

012670307 500 g  
~~€ 61,00~~ € 35,00

## 1293INOX/D8

Serie di 8 giravite in acciaio inox



012930408 551 g  
~~€ 69,00~~ € 39,50



1290INOX ○ 2,5x50-3x75-4x100-5,5x125-6,5x150 mm  
 1292INOX ⊕ PH0x60-PH1x80- PH2x100 mm



Beta  
 INOX  
 STAINLESS STEEL



12" 14" 3/8"

Cricchetto reversibile con attacco quadro

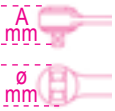

	L mm	Ø mm	A mm	■	g			
900/55	125	25	18	1/4"	90	009000870	<del>€ 39,00</del>	€ 22,00
910/55	200	30	33	3/8"	239	009100882	<del>€ 42,50</del>	€ 24,00
920/55	275	40	43	1/2"	475	009200882	<del>€ 51,50</del>	€ 29,00

12" 14" 3/8"

Cricchetto reversibile con impugnatura rotante

- Sistema di inversione a ghiera sulla testa del cricchetto
- Impugnatura bimatereale

*Avvicinamento rapido del quadro con la sola rotazione dell'impugnatura*

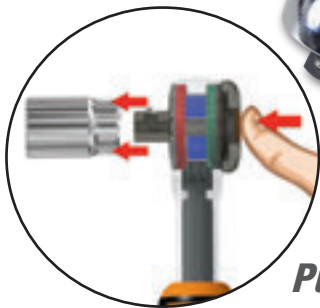

*Pulsante di rilascio della bussola*

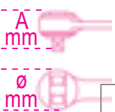

	L mm	Ø mm	A mm	■	g			
900/58	126	28	28,5	1/4"	155	009000884	<del>€ 59,00</del>	€ 33,70
910/58	222	37	38,5	3/8"	417	009100884	<del>€ 65,00</del>	€ 37,50
920/58	281	42,5	45	1/2"	705	009200926	<del>€ 77,00</del>	€ 43,50

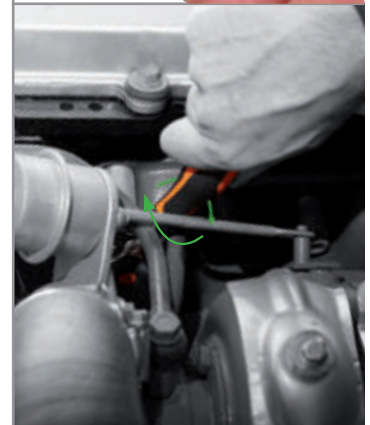

## 920INOX/C16

12"

Assortimento 15 chiavi a bussola e 1 cricchetto in acciaio inossidabile, in cassetta di plastica



**Beta INOX**  
STAINLESS STEEL

	920INOX-A	10-12-13-14-15 16-17-18-19-21 22-24-27-30-32 mm
	920/55INOX	



INOX + NO INOX = RUGGINE



INOX + INOX = NO RUGGINE

GLI UTENSILI BETA INOX POSSONO ESSERE STERILIZZATI IN AUTOCLAVE A 121°C

009203916	3,1 kg
<del>€ 975,00</del>	€ 559,00

387x174x65 mm



14" 14"

Assortimento di 11 chiavi a bussola esagonali, 21 inserti e 7 accessori in cassetta di plastica



	861LP	●	0,6x4,5-1,2x6,5-1,2x8 mm
	861PE	○	2,5-3-4-5-6 mm
	861PH	⊕	PH1-PH2-PH3
	861PZ	⊕	PZ1-PZ2-PZ3
	861RTX	⊗	T10-T15-T20-T25-T27-T30-T40 mm
	892/0	● 1/4" - ■ 1/4"	
	895/1	○ 1/4" - □ 1/4"	
	900	○	5-5,5-6-7-8-9-10-11-12-13-14 mm
	900/20		50 mm
	900/20L		100 mm
	900/25		
	900BG/30C		128 mm

## 900/C39

con cricchetto reversibile (900/55)

009000937 785 g

€ 166,50 € 95,00



## 900/C39-R

con cricchetto reversibile manico rotante (900/58)

009000938 840 g

€ 189,00 € 108,00



14" 14"

Assortimento di 12 chiavi a bussola esagonali, 20 inserti per avvitatori e 7 accessori in termoformato morbido, in cassetta di lamiera

350x150x50 mm



	861LP	●	0,5x3-0,8x5,5-1x5,5-1,2x6,5 mm
	861PE	○	3-4-5-6-8 mm
	861PH	⊕	PH0-PH1-PH2-PH3
	861TX	⊗	T8-T10-T15-T20-T25-T30-T40
	895/1	○ 1/4" - □ 1/4"	
	900	○	4-5-5,5-6-7-8-9-10-11-12-13-14 mm
	900/20		50 mm
	900/21		150 mm
	900/25		
	900/42		115 mm
	900BG/30		128 mm

## 900/C12M

con cricchetto reversibile (900/55)

009000963 1,2 kg

€ 187,50 € 108,00



## 900/C12MR

con cricchetto reversibile manico rotante (900/58)

009000962 1,3 kg

€ 207,50 € 119,50



12" 14"

## 902A/C22

Assortimento di 22 chiavi a bussola esagonali, e 6 accessori, in cassetta di lamiera

14"		900	○	5-5,5-6-7-8-9-10-11-12-13 mm
		900/20		50 mm
		900/25		
		900/55	⊗	
12"		920A	○	10-13-14-15-17-18-19-22-24-27-30-32 mm
		920/21		125 mm
		920/25		
		920/55	⊗	

009020807 3,5 kg

€ 307,00 € 176,00



420x185x60 mm





38

Assortimento di 16 chiavi a bussola esagonali e 5 accessori, in cassetta di lamiera



335x145x60 mm

	910A	6-7-8-9-10-11 12-13-14-15-16 17-18-19-21-22 mm
	910/21	125 mm
	910/22	250 mm
	910/25	
	910/42	210 mm

## 910A/C16

Con cricchetto reversibile (910/55)

009100936 2,3 kg

€ 229,50 € 131,50



## 910A/C16HR

Con cricchetto reversibile impugnatura rotante (910/58)

009100935 2,4 kg

€ 252,00 € 143,00



12

Assortimento di 17 chiavi a bussola esagonali e 5 accessori in termoformato morbido, in cassetta di lamiera



420x185x60 mm

	920A	10-11-12-13-14-15-16-17-18-19 20-21-22-24-27-30-32 mm
	920/21	125 mm
	920/22	255 mm
	920/25	
	920/42	305 mm

## 920A/C17M

con cricchetto reversibile (920/55)

009200924 5 kg

€ 277,00 € 158,00



## 920A/C17MR

con cricchetto reversibile impugnatura rotante (920/58)

009200937 5,1 kg

€ 302,00 € 171,00



34

## 928A/C12

Assortimento di 12 chiavi a bussola esagonali e 5 accessori, in cassetta di lamiera



530x220x80 mm

	928A	22-24-27-30-32-34-36-38-41 46-50-55 mm
	928/21	200 mm
	928/22	380 mm
	928/25	
	928/42	450 mm
	928/55	⊗

009280955 13,5 kg

€ 704,00 € 398,00



## 861PB

**Novità**

1/4

Serie di 6 inserti in braccialetto di tessuto con aggancio magnetico

### Portainseriti magnetico



Permette di cambiare l'inserto con una sola mano

## MIX1

- ⊕ 861PH PH1 - PH2
- ⊕ 861PZ PZ1 - PZ2
- 861PE 4 - 5 mm

008610956 61 g

~~€ 29,50~~ € 16,70



## MIX2

- ⊕ 861PH PH2
- ⊕ 861PZ PZ2
- 861TX TX20 - TX25  
TX30 - TX40

008610966 61 g

~~€ 30,00~~ € 16,90



## 860MIX/A10

1/4

Serie di 10 inserti colorati con portainseriti magnetico, in astuccio tascabile

- 860LP 0,5x3-1,0x5,5-1,2x6,5 mm
- ⊕ 860PH PH1-PH2 (x2)-PH3
- ⊕ 860PZ PZ1-PZ2-PZ3
- 882M1 ○ 1/4" - ● 1/4"



008600900 130 g

~~€ 30,00~~ € 17,50



## 860/C27

1/4

Serie di 25 inserti colorati con raccordo e cricchetto reversibile in astuccio tascabile



- 860LP 0,5x3-1,0x5,5-1,2x6,5 mm
- 860PE 2-2,5-3-4-5-6-mm
- ⊕ 860PH PH1-PH2(x2)-PH3
- ⊕ 860TX T6-T8-T10-T15-T20-T25-T30-T40
- ⊕ 860PZ PZ1 - PZ2(2x) - PZ3
- 860/55 100 mm
- 892/0



008600880 320 g

~~€ 72,00~~ € 41,50



## 860MIX/A31

1/4

Serie di 30 inserti colorati con portainseriti magnetico in astuccio tascabile

- 860LP 0,5x3 - 0,6x4,5 - 0,8x5,5  
1,0x5,5 - 1,2x6,5 mm
- 860PE 2-2,5-3-4-5-6-8-10 mm
- ⊕ 860PH PH0 - PH1 - PH2 - PH3 - PH4
- ⊕ 860RTX T9-T10-T15-T20-T25-T27-T30-T40
- ⊕ 860PZ PZ1 - PZ2 - PZ3 - PZ4
- 882MSR/50 ○ 1/4 ● 1/4



008600902 320 g

~~€ 70,50~~ € 40,90



## 860TX/A10

1/4

Serie di 10 inserti con portainseriti magnetico, in astuccio tascabile

- 860TX T7-T8-T9-T10-T15-T20  
T25-T27-T30-T40
- 882M1 ○ 1/4 ● 1/4

008600970 130 g

~~€ 32,00~~ € 18,70



## 862F/A7

1/4

Serie di 7 inserti a bussola esagonale magnetici, in astuccio tascabile

- 862F ○ 5,5-6-7-8-10-12-13 mm

008620950 350 g

~~€ 41,00~~ € 23,60





## 605E

1/4"

Precisione di serraggio  $\pm 6\%$   
per serraggi destrorsi e sinistrorsi



UNI EN 26789 ISO 6789

	Nm	kgfm	lbf.in	■	L (mm)	g			
605E/5	1÷5	0,1÷0,5	10÷45	1/4"	190	180	006050105	<del>€ 177,00</del>	€ 101,00
605E/10	2÷10	0,2÷1,0	18÷90	1/4"	190	180	006050110	<del>€ 185,00</del>	€ 107,00

## 666N

1/4" 3/8" 1/2"

Precisione di serraggio  $\pm 3\%$   
per serraggi destrorsi



UNI EN 26789 ISO 6789

	Nm	kgfm	lbf.ft	■	L (mm)	g			
666N/2	5÷25	0,5÷2,5	4÷18	1/4"	220	300	006660002	<del>€ 265,00</del>	€ 151,00
666N/2X	5÷25	0,5÷2,5	4÷18	3/8"	220	300	006660003	<del>€ 274,00</del>	€ 153,50
666N/5	10÷50	1÷5	7÷37	3/8"	325	660	006660005	<del>€ 195,00</del>	€ 109,00
666N/10	20÷100	2÷10	15÷75	3/8"	367	730	006660010	<del>€ 197,00</del>	€ 110,00
666N/10X	20÷100	2÷10	15÷75	1/2"	367	800	006660011	<del>€ 201,00</del>	€ 112,00
666N/20	40÷200	4÷20	30÷150	1/2"	465	1010	006660020	<del>€ 214,00</del>	€ 119,50
666N/30	60÷300	6÷30	50÷220	1/2"	581	1380	006660030	<del>€ 244,00</del>	€ 136,00



## 677/C

3/4"

Chiave dinamometrica  
a disinnesto in cassetta.  
Precisione di serraggio  $\pm 4\%$   
per serraggi destrorsi e sinistrorsi



677/C100

UNI EN 26789 ISO 6789

	Nm	kgfm	lbf.ft	■	L (mm)	g			
677/C50	100÷500	10÷50	70÷350	3/4"	915	5,2	006770606	<del>€ 773,00</del>	€ 439,00
677/C70	150÷700	15÷70	100÷500	3/4"	1140	6,2	006770611	<del>€ 804,00</del>	€ 459,00
677/C100	300÷1000	30÷100	200÷750	3/4"	1470	7,5	006770615	<del>€ 946,00</del>	€ 539,00

## 682

Misuratore di coppia elettronico digitale  
con trasduttori porziometrici  
Dynatester 682 funzionamento  
destrorso e sinistrorso

Alta precisione di lettura  
Fornito di uscita seriale RS 232



682/60

10

682/400

22

	Nm	kg			
682/60	1,2÷60	5,9	006820006	<del>€ 4.670,00</del>	€ 2.650,00
682/400	8÷400	6,1	006820040	<del>€ 4.740,00</del>	€ 2.690,00

**CARATTERISTICHE TECNICHE:**  
Precisione di lettura:  $\pm 1\%$  del valore letto  
Unità di misura selezionabili: Nm-dNm-cNm  
Lbf.ft-Lbf.in-Ozf.in-Kgf.m-Kgf.cm-gf.cm  
Alimentazione: 90 a 264V AC a 50/60 Hz  
Dimensioni: 235x185x185 mm  
Verifica di tolleranza secondo norma ISO6789  
Indicazione dell'intervallo di accettabilità specifico  
per ogni chiave dinamometrica testata  
Display: Menu selezionabile in 11 lingue  
Documentazione allegata: Certificato  
di calibrazione con rintracciabilità UKAS

# 665

3/8 12"

## Chiave dinamometrica meccanica a lettura digitale adatta a serraggi destrorsi

- Precisione di serraggio  $\pm 3\%$ , maggiore precisione rispetto ai requisiti di norma
- Impostazione e lettura semplice della coppia tramite valore visualizzato su display
- Il display rimane acceso con valore di coppia impostato
- Lettura della coppia con cifra decimale
- Spegnimento automatico dopo 10 sec. con impostazione della coppia inferiore alla soglia minima
- Alimentazione con 1 batteria da 3 V (inclusa)

MADE IN ITALY



**Novità**

*Elevata autonomia*

*Regolazione digitale della coppia rapida e precisa*

## 665/SW

### Dispositivo di calibrazione

Il dispositivo permette la calibrazione delle chiavi 665 con misuratori di coppia Beta 680 e 682, senza la necessità di smontare la chiave. Dotato di presa Micro USB per consentire futuri aggiornamenti firmware.



006650100 40 g

~~€ 19,00~~ € 10,00

UNI EN 26789 ISO 6789

	Nm	■	D (mm)	A (mm)	L (mm)	g			
665/6	10÷60	3/8	30	33	335	655	006650006	<del>€ 195,00</del>	€ 109,00
665/10	20÷100	3/8	30	33	375	725	006650010	<del>€ 197,00</del>	€ 110,00
665/10X	20÷100	1/2	30	37	375	725	006650011	<del>€ 201,00</del>	€ 112,00
665/20	40÷200	1/2	40	43	470	995	006650020	<del>€ 214,00</del>	€ 119,50
665/30	60÷330	1/2	40	43	590	1260	006650030	<del>€ 244,00</del>	€ 136,00

# 560/...

## Moltiplicatore di coppia destrorso/sinistrorso in valigetta di materiale plastico, rapporto 3,8:1

- Per moltiplicare la forza di serraggio e disserraggio
- Utilizzare esclusivamente con chiavi dinamometriche
- Fornito con piede di reazione

**Novità**

## 560/C3

1500 Nm Max

005600030 4 kg

~~€ 690,00~~ € 398,00

## 560/C3PLUS

2700 Nm Max

005600038 7,5 kg

~~€ 795,00~~ € 458,00



## 1169/D4

Assortimento di 1 pinza universale, 1 pinza becchi mezzotondi lunghi, 1 tronchese e 1 pinza regolabile a cerniera chiusa



1082 160 mm    1150 180 mm    1166 160 mm    1048 250 mm

011690004    1,1 kg  
~~€ 92,50~~    € 54,00



## 1169BM/D3

Assortimento di 1 pinza universale, 1 pinza becchi mezzotondi lunghi e 1 tronchese



1082BM 160 mm

1150BM 180 mm

1166BM 160 mm

011690123    700 g  
~~€ 79,50~~    € 45,50

## 1052

Pinze regolabili autobloccanti ganasce concave

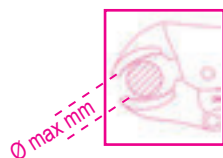

	L mm	Ø Max mm	g			
1052/140	140	22	175	010520014	<del>€ 21,70</del>	€ 12,40
1052/190	190	36	360	010520019	<del>€ 24,50</del>	€ 14,00
1052/240	240	42	590	010520024	<del>€ 26,00</del>	€ 15,00

## 1057A

Pinza automatica autobloccante con regolazione della forza

010570124    620 g  
~~€ 46,00~~    € 26,50



## 1031/S4

Serie di 4 pinze per anelli elastici di sicurezza



1034 170 mm  
 ○ 19 ÷ 60 mm

1032 180 mm  
 ○ 19 ÷ 60 mm

1036 175 mm  
 ● 19 ÷ 60 mm

1038 175 mm  
 ● 19 ÷ 60 mm

010310000    650 g  
~~€ 90,50~~    € 51,50





## 1150INOX

Pinza universale a grande effetto in acciaio inossidabile

- perno decentrato
- cassetta aperta
- elevata resistenza alla corrosione
- evita la ruggine impropria
- ottime caratteristiche meccaniche
- acciaio inossidabile AISI 420

180 mm

**Beta**  
**INOX**  
STAINLESS STEEL



**Novità**

MADE IN ITALY

011500518 227 g

€ 87,00 € 49,50



## 1150HPC

**Novità**

Pinza universale a grande effetto con tagliente ad inserto, perno decentrato, cromata perlata, impugnatura bi-materiale, cassetta aperta

*Patent pending*

Durezza dei taglienti acciaio M2 = **65HRC**

Sforzo di taglio prova statica = **-73%**

Vita media dei taglienti = (test ISO 5744) **+127%**

180 mm

*Finitura cromata perlata*

*Innovazione assoluta grande forza di taglio*

*Durezza taglienti 65HRC*

MADE IN ITALY

011500618 290 g

€ 49,00 € 28,00



## 1047/240

Pinza regolabile a pulsante

- Regolazione rapida e precisa mediante la pressione del pulsante
- Nessuno spostamento accidentale della regolazione
- Trattamento termico localizzato sulle ganasce



L 240 mm    ø Max 36 mm    ☞ Max 32 mm

010470240 340 g

€ 39,00 € 22,50

## 1048

Pinze regolabili cerniera chiusa

- Manici ricoperti con 2 strati di PVC antiscivolo

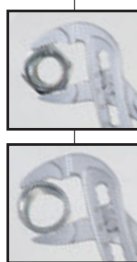

*9 posizioni*

L 250 mm    ø Max 50 mm    ☞ Max 48 mm

010480015 370 g

€ 29,50 € 17,00

## 1009L/DP-S2

Serie di 2 pinze a becchi mezzotondi lunghissimi zigrinati con doppio snodo



1009L/DP

*L 340 mm*



1009L/D

010090060 920 g

€ 61,50 € 35,00



**Novità**

MADE IN ITALY

### 9710 - LUBRIBETA UNIVERSAL

**Sbloccante lubrificante multiuso 7 funzioni**

- Sbloccante;
- Lubrificante;
- Detergente;
- Protettivo antiruggine;
- Disossidante per contatti elettrici;
- Idrorepellente;
- Anticongelante

*Non contiene silicone*



7in1



097100040 400 ml

~~€ 7,60~~ € 4,25

### 9720 - MULTIGREASE

**Grasso lubrificante spray multiuso**

Particolarmente indicato per la lubrificazione di catene, ingranaggi e parti metalliche in movimento, ma anche cerniere, serrature e cardini. Resiste agli attriti e agli agenti atmosferici. Molto resistente a temperature elevate (fino a 210°C). Altamente adesivo. Non cola.



097200040 400 ml

~~€ 6,80~~ € 3,85

### 9740 - BRAKE CLEANER

**Pulitore per freni**

Ideale per la pulizia di dischi e pastiglie freno, motori. Grazie alla sua formulazione permette di eliminare qualsiasi incrostazione di grasso e catrame, senza lasciare residui.

Adatto anche come sgrassante generico di superfici metalliche. Ad evaporazione rapida. Non intacca gomma e plastica.



097400050 500 ml

~~€ 5,40~~ € 2,99

### 9742 - CONTACT CLEANER

**Pulitore per contatti elettrici ed elettronici**

Adatto per pulire e detergere contatti elettronici, circuiti e componenti elettriche in genere. Grazie alla sua consistenza poco densa, si distribuisce in modo uniforme e velocemente sulla superficie trattata, eliminando unto e sporco, senza lasciare residui oleosi. Ad evaporazione rapida. Non intacca plastica e gomma.



097420040 400 ml

~~€ 7,50~~ € 4,20

### 9802M

**Frenafili media resistenza per accoppiamenti metallici filettati**

Permette lo smontaggio con l'uso di utensili manuali.



ml		
20	098020002	<del>€ 9,50</del> € 5,45
50	098020005	<del>€ 14,50</del> € 8,35
250	098020025	<del>€ 37,00</del> € 21,40

### 9803H

**Frenafili alta resistenza per accoppiamenti metallici filettati**

Non consente lo smontaggio con utensili manuali.



ml		
20	098030002	<del>€ 9,50</del> € 5,45
50	098030005	<del>€ 14,50</del> € 8,35
250	098030025	<del>€ 37,00</del> € 21,40

### 9851

**Colla istantanea**

Per giunzioni strutturali istantanee. A base di cianoacrilato etilico. Consente l'adesione di una vasta gamma di materiali come metallo, plastiche, cuoio, legno ed altri svariati tipi di substrato anche in combinazione tra loro.



g		
20	098510002	<del>€ 9,00</del> € 5,20



### 412M/SP19 **Novità**

Serie di 19 punte elicoidali cilindriche, in acciaio HSS, AISI M2, interamente rettificata

- Autocentrante
- Performance e precisione di taglio elevate
- Per forare acciai legati, ghise e metalli in genere

Ø 1÷10 x 0,5 mm

R ≤ 850 N/mm<sup>2</sup>  
HV ≈ 820  
DIN 338

004120469 590 g

€ 65,00 € 37,50

### 415CO/SP19A

Serie di 19 punte elicoidali cilindriche, in acciaio HSS-CO 5%

- Per forare acciaio INOX, acciai legati, ghisa, acciai dolci, leghe leggere

Ø 1÷10 x 0,5 mm

R ≤ 1400 N/mm<sup>2</sup>  
HV ≈ 850÷920  
DIN 338

115x170x40 mm

004150440 590 g

€ 114,00 € 65,00

### 412/SP25P **Novità**

Serie di 25 punte elicoidali cilindriche, in acciaio HSS rettificata lucida

Ø 1÷13 x 0,5 mm

R ≤ 700 N/mm<sup>2</sup>  
HV ≈ 750÷820  
DIN 338

004120415 1,1 kg

€ 103,00 € 59,50

### 426HS/SP10 **Novità**

Serie di 10 frese rotative in HSS, codolo da 6 mm

- 5 frese taglio grossolano: per leghe leggere, rame, ottone e bronzo
- 5 frese taglio mezzo dolce: per acciai e ghisa

004260210 400 g

€ 258,00 € 149,00

### 446/C110

Assortimento di 105 maschi e filiere con 5 accessori in acciaio al cromo, filettatura metrica in cassetta di legno

500x337x60 mm

004460060 8 kg

€ 717,00 € 410,00

430 M mm	433 M mm	440/440A M mm	441/441A M mm
2x0,4	6x0,75 - 7x0,75	2x0,4	6x0,75 - 7x0,75
3x0,5	8x0,75 - 8x1	3x0,5	8x0,75 - 8x1
4x0,7	9x0,75 - 9x1	4x0,7	9x0,75 - 9x1
5x0,8	10x0,75 - 10x1	5x0,8	10x0,75 - 10x1
6x1	10x1,25 - 11x0,75	6x1	10x1,25 - 11x0,75
7x1	11x1 - 11x1,25	7x1	11x1 - 11x1,25
8x1,25	12x0,75 - 12x1	8x1,25	12x0,75 - 12x1
9x1,25	12x1,25 - 12x1,5	9x1,25	12x1,25 - 12x1,5
10x1,5	14x1 - 14x1,25	10x1,5	14x1 - 14x1,25
11x1,5	14x1,5 - 16x1	11x1,5	14x1,5 - 16x1
12x1,75	16x1,5 - 18x1,5	12x1,75	16x1,5 - 18x1,5
14x2		14x2	
16x2		16x2	

### 425/SP3

Serie di 3 frese coniche a gradino in acciaio HSS

Ø 4÷30 mm

004250030 450 g

€ 242,00 € 140,00





## 31BM/D6

Serie di 6 cacciapina con impugnatura

Ø 2-3-4-5-6-8 mm



000310420 805 g  
~~€ 86,00~~ € 50,00

## 32AU

Bulino automatico con corpo brunito

- Forza d'urto regolabile fino a 50 Kg
- Utilizzabile con una sola mano



L 150 mm

000320160 135 g  
~~€ 45,50~~ € 26,50

## 1370

Martelli tipo tedesco manico in legno



	g	g		<del>€</del>	€
1370/300	300	439	013700053	<del>€ 12,50</del>	€ 7,30
1370/500	500	669	013700055	<del>€ 15,30</del>	€ 9,00
1370/800	800	949	013700058	<del>€ 20,00</del>	€ 11,80
1370/1000	1000	1180	013700060	<del>€ 23,40</del>	€ 13,80
1370/1500	1500	1722	013700065	<del>€ 27,50</del>	€ 16,20
1370/2000	2000	2181	013700070	<del>€ 32,50</del>	€ 19,00

## 1370T

Martelli tipo tedesco manico in fibra di vetro



	g	g		<del>€</del>	€
1370T/300	300	452	013700630	<del>€ 18,50</del>	€ 10,90
1370T/500	500	663	013700650	<del>€ 20,00</del>	€ 11,60
1370T/800	800	1017	013700680	<del>€ 21,50</del>	€ 12,50
1370T/1000	1000	1279	013700700	<del>€ 27,50</del>	€ 16,00
1370T/1500	1500	1740	013700750	<del>€ 32,00</del>	€ 18,50

## 1390

Mazzuole con battenti intercambiabili in materiale plastico manico in legno



	Ø mm	g		<del>€</del>	€
1390/22	22	134	013900022	<del>€ 15,30</del>	€ 8,80
1390/28	28	230	013900028	<del>€ 18,80</del>	€ 10,90
1390/35	35	365	013900035	<del>€ 25,50</del>	€ 14,70
1390/45	45	698	013900045	<del>€ 41,00</del>	€ 23,80
1390/60	60	1462	013900060	<del>€ 70,00</del>	€ 40,50

## 1500N

Estrattori universali a 2 griffe scorrevoli

- Il particolare disegno della griffa permette un bloccaggio automatico della stessa sotto carico
- Impiego sia per esterni che per interni
- Griffe mobili lungo la traversa

	A min (mm)	A max (mm)	L (mm)			
1500N/0	18	65	70	015000600	<del>€ 62,00</del>	€ 34,90
1500N/1	23	70	100	015000601	<del>€ 65,00</del>	€ 36,80
1500N/2	23	100	100	015000602	<del>€ 70,00</del>	€ 40,00
1500N/3	35	140	150	015000603	<del>€ 116,00</del>	€ 66,50
1500N/4	35	190	150	015000604	<del>€ 125,00</del>	€ 72,00
1500N/5	43	250	205	015000605	<del>€ 240,00</del>	€ 139,00
1500N/6	43	320	205	015000606	<del>€ 260,00</del>	€ 149,00

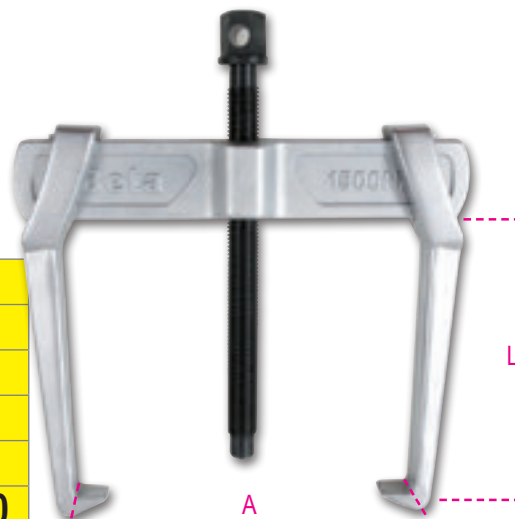

## 1430/S8

Serie di 8 estrattori conici per viti e prigionieri danneggiati destrorsi in astuccio di plastica

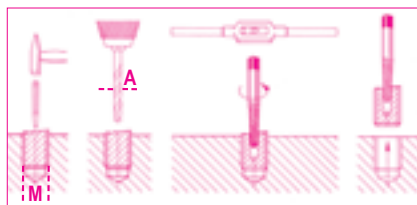

	M	A mm
1430/1	3÷6	2,5
1430/2	6÷8	3,0
1430/3	8÷11	4,5
1430/4	11÷14	6,0
1430/5	14÷18	8,0
1430/6	18÷24	11,0
1430/7	24÷33	14,0
1430/8	33÷50	21,0



014300108 745 g  
~~€ 67,00~~ € 39,30

## 1545/C5M

Estrattore 1542/1 con 5 Espansori 1544



265x180x45 mm

015450011 2,4 kg  
~~€ 449,00~~ € 258,00

	A mm	C mm
1544/1	9÷12	0,80
1544/2	13÷17	1,15
1544/3	16÷21	1,70
1544/4	20÷25	1,65
1544/5	25÷30	2,00

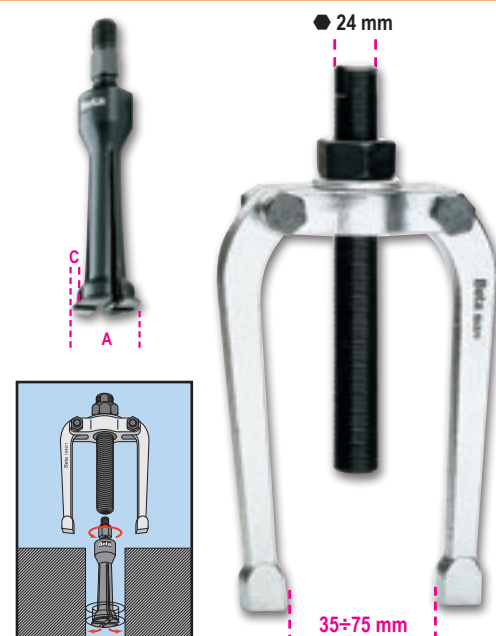

## 1651DGT

Calibro digitale a corsoio in acciaio inossidabile temprato in astuccio rigido di materiale plastico

- lettura centesimale
- bloccaggio a vite del corsoio
- conversione mm/pollici



DIN 862

UNI EN ISO 13385-1

## 1651DGT/150

A Max 150 mm L 225 mm

016510111 150 g

~~€ 106,00~~ € 61,50

## 1651DGT/200

A Max 200 mm L 285 mm

016510112 425 g

~~€ 124,00~~ € 71,00

## 1650

Calibro a corsoio in acciaio inossidabile temprato

- Lettura ventesimale
- Bloccaggio a molla

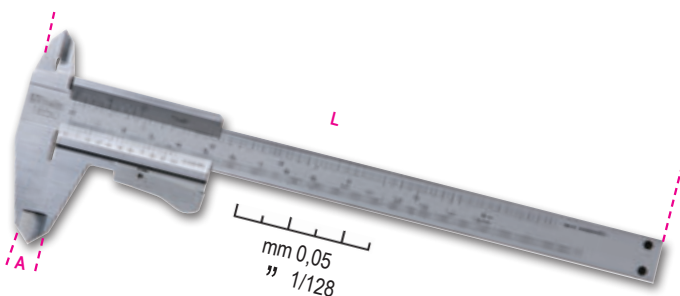

DIN 862

UNI EN ISO 13385-1

## 1650/150

A Max 150 mm L 235 mm

016500001 170 g

~~€ 51,50~~ € 29,80

## 1650/200

A Max 200 mm L 290 mm

016500002 230 g

~~€ 67,50~~ € 39,00

## 1691BM

Flessometri cassa bimateriale in ABS antiurto nastro in acciaio, classe di precisione II

	L (m)	S(mm)	g (g)			
1691BM/5	5	25	275	016910205	<del>€ 13,00</del>	€ 7,30
1691BM/8	8	32	490	016910208	<del>€ 19,40</del>	€ 10,90
1691BM/10	10	32	630	016910210	<del>€ 23,50</del>	€ 13,30

## 437P

Ravvivafiletti, per ripristino di filettature interne ed esterne, destre e sinistre P 0,80÷3,00 mm

**Novità**



004370003 122 g

~~€ 39,00~~ € 22,50

## 437U/09

Kit di ripristino delle filettature danneggiate

- M5X0,8
- M6X1,0
- M8X1,25
- M10X1,5
- M12X1,75



004370550 2 kg

~~€ 278,00~~ € 160,00

370x230x55 mm

## 1726BM

Seghetto con sistema di tensionamento della lama a sgancio rapido

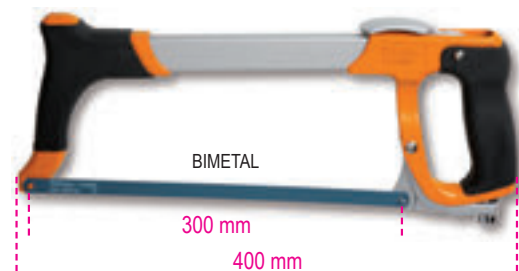

BIMETAL

300 mm

400 mm

017260050 800 g

~~€ 38,00~~ € 21,80



professional



## 1606T

Pinza per capicorda a tubetto, crimpatura su 4 lati



016060005 450 g

€ 250,00 € 145,00

0,1÷10 mm<sup>2</sup>

## 1149F

Pinza spellafili frontale autoregolabile, con dispositivo di taglio

- Adattamento automatico ai diametri dei conduttori
- Lunghezza della spellatura regolabile
- Regolazione della pressione di taglio isolante
- Dispositivo di taglio integrato



011490010 500 g

€ 14,30 € 8,20

0,2÷6 mm<sup>2</sup>

## 1760/RMS

Multimetro digitale industriale con gomma esterna antiscivolo ed antiurto

- Ingressi protetti • Autoranging
- Ampio display di immediata lettura, retroilluminato blu
- Sonda temperatura tipo K (inclusa)
- Autospegnimento
- Base in gomma portaterminale per un maggiore comfort durante l'uso
- Terminali a doppio isolamento 1000V, lunghezza 1 m
- In custodia morbida
- CAT IV 600V/ CAT III 1000V
- Vero valore efficace TRUE RMS



	Campo di misura	Precisione base
Tensione AC/DC	110mV - 600V ±0.8%	- ±2% rdg
Corrente AC/DC	110µA - 10A ±1.5%	- ±2% rdg
Resistenza	110Ω - 40MΩ ±1.2%	- ±2.5% rdg
Capacità	11nF - 40mF ±5%	- ±10% rdg (fino a 11mF)
Frequenza	1100Hz - 110 MHz ±1.2%	- ±1.5% rdg
Temperatura	-32°C - +1000°C ±3%	- ±5% rdg
Test diodi	3V dc ±10% rdg	
Test continuità	<30 Ω	

017600020 800 g

€ 243,00 € 141,00



## 1609B

Pinza crimpatrice meccanica

- Per capicorda in rame non isolati da 10 a 120 mm<sup>2</sup>
- Impugnatura in gomma antiscivolo
- Perno interno con sezione ad "H" per la massima scorrevolezza del punzone
- In acciaio brunito

L 600 mm



10÷120 mm<sup>2</sup>

016090101 4,2 kg

€ 255,00 € 148,00

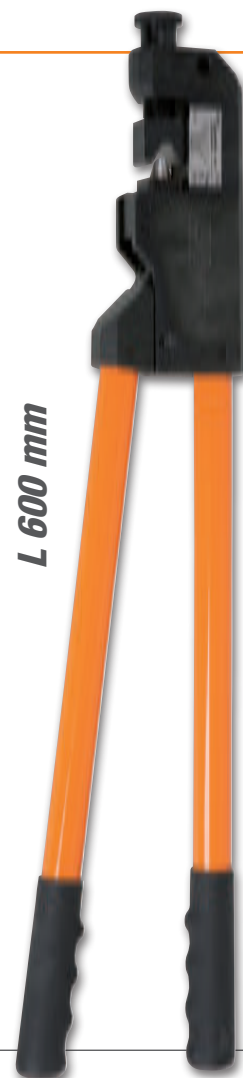

## 1256/C36-2

Microgiravite bimateriale con 36 inserti intercambiabili da 4 mm e prolunga magnetica

1256TX	⊙	T3-T4-T5-T6-T7-T8-T9-T10-T15
1256RTX	⊙	T6-T7-T8-T9-T10
1256LP	⊙	0,8-1,2-1,5-1,8-2-2,5-3-3,5-4 mm
1256PE	⊙	0,7-0,9-1,3-1,5-2 mm
1256PH	⊙	PH000-PH00-PH0-PH1
1256PZ	⊙	PZ000-PZ00-PZ0-PZ1
1256/20		
1256/30		

130x60x35 mm



012560100 200 g

€ 56,00 € 32,50





## 1740B 330

**Rivettatrice di potenza compatta**

Rapporto di leva ottimizzato per una maggiore compattezza e praticità d'uso  
Testa regolabile per tirare il rivetto da 2 a 5 movimenti dei bracci



3,2÷6,4 mm acciaio



**3 griffe:  
miglior presa  
del rivetto**

017400330 1 kg

~~€ 70,50~~ € 40,50



*Serbatoio portasteli*

## 1741B

**Rivettatrice con  
4 testine intercambiabili**

- Struttura in lega leggera
- Con chiave di servizio

017410000 600 g

~~€ 32,00~~ € 18,50



## 1741U

**Rivettatrice ultra compatta  
con regolazione dello sforzo  
fornita con 4 testine intercambiabili**



**3 griffe:  
miglior presa  
del rivetto**

L 200 mm

017410450 450 g

~~€ 38,00~~ € 21,70



## 1749AC

**Pistola ad alta spinta per ancoranti chimici  
e cartucce standard**

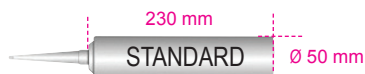

017490005 1 kg

~~€ 31,50~~ € 18,50

## 1749A

**pistola per sigillante modello professionale  
tubo in alluminio, per cartucce e sacchetti**



017490010 803 g

~~€ 35,00~~ € 19,90

## 1750

**Compressori a leva  
per grasso, 500 cc**



**550 Bar**

017500500 1,2 kg

~~€ 34,50~~ € 20,00

## 7042LCD

Maschera LCD ad oscuramento automatico, per saldatura ad elettrodo, MIG/MAG, TIG e plasma. Alimentazione a celle solari e batterie al litio per una durata eccezionale del filtro LCD

- Area di visuale 98x43 mm
- Tonalità di oscuramento DIN 9-13 con regolazione esterna
- Protezione UV/IR
- Tempo d'oscuramento 1/25000 s
- Tempo di rischiaramento 0.25-1s
- Sensibilità e ritardo dell'oscuramento regolabili
- Accensione e spegnimento automatici
- Funzione di smerigliatura
- Forma ottimizzata per agevolare la respirazione a schermo abbassato



070420001 900 g  
 € 156,00 € 89,50

## 1860 160A

Saldatrice ad inverter con uscita corrente continua (DC) per saldature ad elettrodo MMA e TIG su acciaio

Compatta e facile da trasportare. Funzioni arc force, hotstart, anti-sticking, protezione termostatica



Corrente di regolazione:	5÷160A
Alimentazione:	1 x 230V
Fattore di utilizzo (40°C):	30% - 160 A 60% - 130 A 100% - 110 A
Fusibile ritardato:	25A
Protezione:	IP23S
Uso con generatori:	✓
Cavo:	25 mm <sup>2</sup>
Elettrodi utilizzati:	Ø 1.5 - 4 mm rutilici, basici, inox, ghisa, ecc.

018600006 7,8 kg  
 € 740,00 € 416,00

## 1860SQ

Squadra magnetica 45°/90°

- Ideale per bloccare particolari tubolari o piatti
- 25 kg di forza magnetica
- Non necessita batteria, effetto ON/OFF ottenuto con l'inclinazione dei magneti interni
- Pulizia da trucioli agevolata coi magneti in posizione OFF

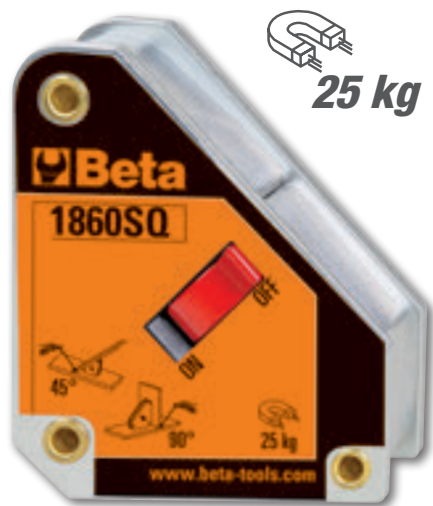

25 kg



018600210 700 g  
 € 68,50 € 39,50





## 1852R1750

### Riscaldatore ad induzione portatile

- Riscalda e sblocca bulloni, dadi, mozzi e cuscinetti particolarmente bloccati senza l'utilizzo di fiamme
- Permette di scaldare qualsiasi tipo di metallo ferromagnetico

### Massima sicurezza senza l'uso di fiamme



480x370x130 mm

### Dati tecnici:

- Tensione di ingresso: 230V AC, 50/60 Hz
- Corrente di ingresso: max. 7,5A
- Potenza: max. 1.75 kW

### VANTAGGI

- 1 Risparmio di tempo:** riscaldamento veloce e con grande precisione
- 2 Sicurezza anti incendio:** non genera fiamme, massima sicurezza per l'operatore
- 3 Praticità:** utilizzabile con una sola mano e serpentine facilmente intercambiabili

### CAMPI DI APPLICAZIONE

- Automotive
- Manutenzione industriale
- Industria aeronautica
- Industria navale
- Industria petrolchimica

### Dotazione:

- Due serpentine frontali con diametro 19 e 26 mm per sblocco dadi **1**
- Una serpentina piatta per scaldare le superfici **3**
- Una serpentina flessibile lunga 800 mm **2**
- Valigetta di plastica

018520175 4,5 kg  
€ 1.215,00 € 698,00

## 1827F

### Saldatore a gas butano ricaricabile

- Maxi serbatoio da 35g
- Tre ugelli intercambiabili da 550°C; 1000°C e 1300°C
- Fornito con cavalletto in valigetta rigida

### Per deformare plastiche e sbloccare parti metalliche



018270200 1,5 kg  
€ 122,00 € 71,00

## 1870

### Aspiratore 20 litri per solidi e liquidi

#### Caratteristiche tecniche:

tensione:	230/240 V
frequenza:	50/60 Hz
potenza Max:	1200 W
portata d'aria:	58 l/sec.
depressione Max:	190 mbar
capienza Max bidone:	20 l
emissioni acustiche:	<70 dB(A)
lunghezza cavo:	5 m

#### Accessori in dotazione ø 36 mm:

tubo corrugato:	✓
tubi rigidi:	✓
spazzola multiuso:	✓
bocchetta a lancia:	✓
raccordo di gomma Ø int.:	x
<b>SISTEMI FILTRANTI</b>	
cartuccia filtro aria:	✓
filtro anti-schiuma:	✓
sacco in dotazione:	x

Sacchetto non incluso



Ruote antitraccia

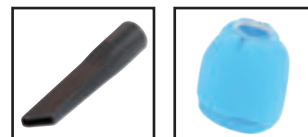

018700020 6,9 kg  
€ 184,00 € 106,00

### 334

Tagliatubi per rame e leghe leggere

*Con lama svasatubi*



Ø 3÷30 mm  
1/8"÷1"1/8"

003340001 292 g  
~~€ 25,50~~ € 14,70

### 342

Cesoia a cricchetto per tubi in materiale plastico



003420030 500 g  
~~€ 42,50~~ € 24,80

Ø 0÷42 mm  
1"5/8"

### 363

Giratubi modello americano con corpo in lega leggera e ganasce in acciaio forgiato



	L (m)	Ø (")	Ø (mm)			
363 350	350	2" gas	60	003630035	<del>€ 57,00</del>	€ 33,00
363 450	450	2 1/2" gas	76	003630045	<del>€ 76,00</del>	€ 44,00
363 600	600	3" gas	90	003630060	<del>€ 128,00</del>	€ 74,00
363 900	900	5" gas	140	003630090	<del>€ 240,00</del>	€ 139,00

### 352U

Attrezzo bordatubi regolabile per rame e leghe leggere

- La speciale morsa di cui è dotato lo rende compatto e funzionale

Ø 5÷16 mm  
3/16"÷5/8"

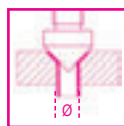

003520101 860 g  
~~€ 79,00~~ € 45,50

### 186 8-32

Chiave autoserrante a ripresa automatica per esagoni da 8 a 32 mm

Ideale per viti con testa a profilo: esagonale, Spline®, quadrato, Torx®; anche rovinate.

L 260 mm



SPLINE® 12 lati quadrato Torx® esagonale teste rovinate al 70%



001860008 560 g  
~~€ 41,50~~ € 23,80



## 1838COB

Lampada ricaricabile compatta con LED ad altissima luminosità

- Batteria ai polimeri di litio
- Corpo compatto in gomma antiscivolo
- Gancio orientabile
- Base magnetica orientabile a 180 gradi
- Con caricatore 100-240Vac / 50-60Hz
- 100 / 200 lumen - Spot 75 lumen
- Autonomia: 6 h / 3 h
- IP65



018380010 200 g  
~~€ 75,00~~ € 43,00



120x59x25 mm

## 1836A

Lampada da testa a LED, con doppia luminosità e sensore ON/OFF contactless

- 120/65 lumen
- IP54
- pile: 3xAAA incluse

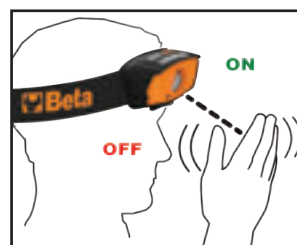

018360050 215 g  
~~€ 43,00~~ € 25,00

## 1834P...

Torcia LED ad alta luminosità in robusto alluminio anodizzato

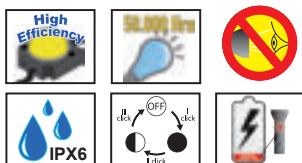

**1834P XL**  
 018340330 300 g  
~~€ 77,50~~ € 44,50

**1834P L**  
 018340325 270 g  
~~€ 61,50~~ € 35,70

**1834P M**  
 018340320 120 g  
~~€ 37,50~~ € 21,50

**1834P S**  
 018340310 56 g  
~~€ 31,00~~ € 18,00



finitura opaca

## 1838SLR

Lampada a LED snodata ricaricabile

- LED compatto frontale (200 lumen) e in testa per ispezioni (100 lumen)
- Corpo illuminante di soli 9 mm di spessore
- Autonomia di 5/2.5 ore (in base al livello di luce impostato)
- Con caricatore USB
- Con gancio metallico e magnete



9 mm  
 100 lumen  
**Compatta e versatile**

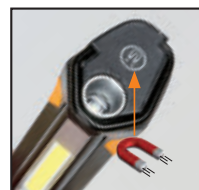

018380201 200 g  
~~€ 86,50~~ € 51,00



242x41x30 mm



# 1837C

Faretto ricaricabile a LED da cantiere

- 3 intensità luminose
- Carica batterie:  
input: 100-240V AC - 50/60Hz;  
output: 15V 1.5A
- Tempo di ricarica: 4 ore
- Indicatore di carica a 3 LED
- Orientabile a 180°
- IP65
- IK07



**Novità**



## 1837C/2100

500/1000/2100 lumen



220x225x70 mm

018370210 1,1 kg

€ 154,00 € 89,00



## 1837C/4300

1100/2200/4300 lumen



266x236,6x59 mm

018370430 1,3 kg

€ 223,00 € 129,00

# 1838FLASH

Faretto ricaricabile ultracompatto, studiato per offrire la migliore soluzione possibile in ogni utilizzo

- LED ad altissima luminosità
- IP65
- Robusto ed affidabile
- Batteria ai polimeri di litio 7,4 V 4000 mAh



90°



**Illuminazione abbondante e sempre pronta:**

Con una capacità illuminante massima di 720 Lumen e con la possibilità di lavorare a batteria o a cavo è sempre pronto all'uso.



360°

1/4"

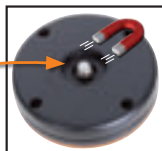

12V



230V

5 m

018380300 820 g

€ 270,00 € 155,00



85x100x155 mm

# 1837S

Treppiede telescopico per supporto faretto da cantiere

- In metallo
- Altezza variabile 70÷155 cm

**Compatibile con 1837C e 1838FLASH**



**Novità**

018370500 2,4 kg

€ 48,00 € 27,50



## 1838/11LED

Lampada ricaricabile con LED ad altissima luminosità batteria ai polimeri di litio

- Corpo compatto in gomma antiscivolo
- Con stazione di ricarica 110-230Vac/50-60Hz



**LED in testa per illuminazione multi direzionale**



**Vetrino frontale facilmente sostituibile**



**Gancio orientabile**



018380111 700 g

€ 133,50 € 76,50



## 1842LED/ABM

Lampada con LED ad altissima luminosità, 12-24 V; AC-DC

- Corpo compatto in gomma antiscivolo
- Vetrino frontale facilmente sostituibile
- Gancio orientabile
- Con LED in testa per illuminazione multidirezionale
- Cavo da 10 m



018420311

1,1 kg

€ 103,50

€ 59,00



## 1846LED/BM

Avvolgitore automatico completo di lampada a LED, 100-240 Vac

- Con trasformatore di sicurezza 230/12V - Max. 60 W
- Cavo da 15 m



018460301

5,8 kg

€ 332,00

€ 189,00



## 1848

Avvolgitore automatico con presa Schuko

- Max 1600 W a cavo svolto
- Max 1200 W a cavo avvolto
- Cavo in gomma antiscivolo H07 - 3x1.5 mm<sup>2</sup> - 15m
- Con protezione termica



018480015

5,2 kg

€ 299,00

€ 169,00



## 1128FXS

Forbici per elettricisti con svasatore lame dritte in acciaio inossidabile con microdentatura, gola tranciavo e crimpatore per terminali a tubetto

- Custodia snodata agganciabile alla cintura
- Impugnatura bimatereale
- Perno anti-allentamento
- Profilo e fresa: studiate per allargare fori su plastica da 13 a 21 mm



011280095

80 g

~~€ 32,50~~

€ 18,70

## Una nuova prospettiva

Abbiamo ridisegnato la forbice per elettricisti osservando il lavoro quotidiano degli utilizzatori. L'abbiamo resa un **utensile universale**, inglobando le 4 funzioni principali in un unico oggetto.

**Novità**

**Brevettata**



### TAGLIO

rapido e netto per cavi fino a 50 mm<sup>2</sup> grazie alla gola trancia-cavo e a una lama microdentata per una maggior presa.

### SPELLATURA

la sensibilità del perno anti-allentamento permette di spellare con precisione anche i cavi più fini.

### CRIMPATURA

sicura e resistente nel tempo per terminali a tubetto.

### SVASATURA

l'esclusivo profilo a fresa brevettato consente di svasare i fori delle cassette di derivazione in maniera precisa e pulita.

## 1128BAX

Forbici per elettricisti a doppio effetto, con profili a fresa in acciaio inossidabile rivestito in DLC

- Alta durezza superficiale delle lame (resistenza all'abrasione e mantenimento dell'affilatura nel tempo)
- Basso coefficiente di attrito (scorrevolezza e potenza di taglio)
- Fornite con custodia plastica snodata



011280088

160 g

~~€ 28,00~~

€ 16,00



**+durezza  
-coefficiente  
d'attrito**

**BREVETTATA**

Profilo e fresa: studiate per allargare fori su plastica da 13 a 25 mm.

## 1778SOS

Coltello soccorso auto con funzione martello frangicristallo e tagliacinture di sicurezza, in astuccio

- Con clip e custodia in tessuto con passacintura
- Impugnatura in alluminio anodizzato
- Blocco lama di sicurezza



017780080

184 g

~~€ 27,50~~

€ 15,80

## 1771HD **Novità**

Cutter 18 mm fornito con 6 lame

- Caricamento automatico della lama
- Sistema bloccalama a vite



017710100

170 g

~~€ 19,00~~

€ 10,90

## 1772M

Cutter a lama retrattile di sicurezza fornito con 4 lame

- Lama con rientro automatico a molla
- Corpo robusto in lega pressofusa
- Levapunti integrato nel manico



Profondità di taglio regolabile Ø÷25 mm

017720040

160 g

~~€ 15,30~~

€ 8,85





## 1273MQ/D6



Serie di 6 giravite isolati

1274MQ ● 3x100-4x100-5,5x125 mm

1272MQ ⊕ PH0x60-PH1x80-PH2x100 mm

**1000 V**



012730851 500 g

€ 56,50 € 32,50

## 1273MQ/F-D6



Serie di 6 giravite slim isolati

1274MQ/F ● 0.5x3,5x100 - 0.8x4,5x100 -

1x5,5x125 - 1.2x6,5x150 mm

1272MQ/F ⊕ PH1x4.5x80- PH2x6x100 mm



**1000 V**



012730406 500 g

€ 65,00 € 37,79

## 1760/OHM

Multimetro/megaohmetro per test isolamento ad alta tensione. Lettura a valore efficace TRUE RMS.



CAT. IV 600V  
CAT. III 1000V

### Campo di misura

Tensione AC/DC: 50mV - 1000V  
Corrente AC/DC: 0.01µA - 10A  
Resistenza : 0.01Ω - 50MΩ  
Meg OHM: 0.01 - 5000MΩ  
Capacità: 5nF - 10mF  
Frequenza: 50Hz - 100 MHz  
Temperatura: -50°C - +1350°C  
Test diodi: 3V dc  
Test continuità: <30 Ω

### Precisione base

±0.06% - ±0.1% rdg  
±0.5% - ±1% rdg  
±0.2% - ±2% rdg  
±4% rdg. max current 1mA  
±1.5% - ±3% rdg  
±0.02% - ±0.1% rdg  
±0.5% rdg

017600025 500 g

€ 675,00 € 390,00

## 1169MQ/D2

Assortimento di 1 pinza universale isolata e 1 tronchese isolato

**1000 V**



1150MQ 180 mm

1082MQ 160 mm



011690143 600 g

€ 81,50 € 47,50

## 2115P L-MQ32

Assortimento di 32 utensili isolati per auto ibride, in cestello plastico con termoformato morbido



021150332 6,7 kg  
 € 974,00 € 555,00

### N. pezzi/Descrizione

N. pezzi/Descrizione	Beta N.
1 cricchetto reversibile 1/2"	920MQ/55A
2 chiavi poligonali semplici 10-12 mm	89MQ
1 portainseri magnetico isolato 1/4"	850MQ
10 inserti con portainseri magnetico T7-T8-T9-T10-T15-T20-T25-T27-T30-T40	860TX/A10
7 chiavi a bussola esagonali 8-10-12-13-14-17-19 mm	920MQ/A
1 prolunga quadro maschio e femmina 1/2" 125mm	920MQ/21
1 prolunga quadro maschio e femmina 1/2" 250mm	920MQ/22
1 pinze regolabili a cerniera chiusa 250mm	1048MQ
1 pinza universale 1000V 180mm	1150MQ
1 pinze a becchi piatti lunghissimi piegati 160mm	1164MQ
2 giravite Phillips 1000V 4.5X80-6X100mm	1272MQ
3 giravite lama parallela 1000V 3X100-4X100-5.5X125	1274MQ
1 guanti isolanti, in lattice G2	1995MQ/G2
1 cestello modello lungo in materiale plastico	CP15L

## 5988VHB-MQ

Assortimento di 66 utensili isolati 1000V in termoformato morbido.

**Novità**

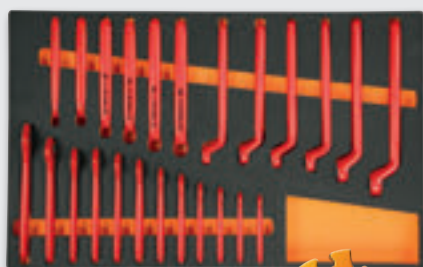

M49

24



M108

27



M161

15

### N. pezzi/Descrizione

N. pezzi/Descrizione	Beta N.
12 chiavi a forchetta 1000V 7-8-10-11-12-13-14-15-16-17-19-22 mm	52MQ
12 chiavi poligonali semplici 7-8-10-11-12-13-14-15-16-17-19-22 mm	89MQ
4 chiavi a bussola maschio esagonale 4-5-6-8 mm	910MQ/PE
11 chiavi a bussola poligonali 7-8-10-11-12-13-14-15-16-17-19 mm	910MQ/B
6 chiavi a bussola maschio per viti con impronta Torx T15-T20-T25-T27-T30-T40	910MQ/TX
2 chiavi a bussola maschio a profilo XZN 8-10 mm	910MQ/XZN
1 prolunga quadro maschio e femmina 3/8" 125 mm	910MQ/21
1 prolunga quadro maschio e femmina 3/8" 250 mm	910MQ/22

### N. pezzi/Descrizione

N. pezzi/Descrizione	Beta N.
1 quadro maschio 3/8", a T	910MQ/T
1 cricchetto reversibile con attacco quadro maschio 3/8"	910MQ/55
1 forbici per elettricisti	1128MQ
1 pinze regolabili a cerniera chiusa 250 mm	1048MQ
1 tronchesi a taglianti diagonali 1000V 160 mm	1082MQ
1 pinza universale 1000V 180 mm	1150MQ
1 pinze a becchi piatti lunghissimi diritti 160 mm	1162MQ
1 pinze a becchi piatti lunghissimi piegati 160 mm	1164MQ
4 giravite Phillips 1000V PH0x60 - PH1x80 - PH2x100 - PH3x150 mm	1272MQ
4 giravite lama parallela 1000V 2,5x75 - 3x100 - 4x100 - 5,5x125 mm	1274MQ
1 coltello spellacavi isolato	1777MQ/U

059880400 6,2 kg  
 € 2.315,00 € 1.318,00



## 7103K4

**Novità**

Kit di delimitazione per veicoli ibridi o elettrici in attesa di riparazione. Composto da 4 colonnine da 90 cm e catena plastica da 25 m.



4x

071030001  
 € 103,00 € 59,00

## 7109/S7

**Novità**

Serie di 7 cartelli per il rischio elettrico, struttura in alluminio



071090107  
 € 61,00 € 35,50



## 3050/600

**Novità**

### Sollevatore moto elettroidraulico da 600 kg

Caratteristiche tecniche

- sicurezze elettriche, meccaniche e idrauliche
- portata: 600 kg
- centralina elettroidraulica integrata: 230V - 50 Hz
- pompa idraulica
- velocità di discesa controllata
- fusibili di sicurezza in caso di tranciatura del cavo
- pulsantiera di comando
- certificato CE omologato TÜV



198 kg

3050

030500201

030500202

030500203

~~€ 4.380,00~~

**€ 2.498,00**

## 9562T3

**Novità**

### Tappeto da officina 300x160 cm

- particolarmente indicato per l'utilizzo sotto ponti sollevatori moto
- protegge il suolo da perdite d'olio, benzina e rispetta l'ambiente
- facile da pulire, fondo gommato ed antiscivolo



095620300

4,8 kg

~~€ 277,00~~

**€ 159,00**

## 3040C

### Cavalletto posteriore per moto regolabile

- Verniciatura nera opaca
- 4 ruote in gomma termoplastica
- Include coppia di cursori a V
- Include coppia di cursori a L

**Novità**



030400002

4,8 kg

~~€ 64,00~~

**€ 37,00**

## 3043C

### Cavalletto per moto con monobraccio sinistro

- Verniciatura nera opaca
- 4 ruote in gomma termoplastica

**Novità**



030430002

6,5 kg

~~€ 79,00~~

**€ 45,50**

## 3041C

### Cavalletto anteriore per moto regolabile

- Verniciatura nera opaca
- 4 ruote in gomma termoplastica
- Include coppia di cursori a rulli
- Include coppia di cursori a cono

**Novità**



030410002

5 kg

~~€ 60,00~~

**€ 34,50**



## 1498/16A

### Caricabatterie elettronico 12-24V multifunzione

- display grafico retroilluminato
- corrente massima di carica 16A continui
- carica e mantenimento
- protezione contro inversione polarità, corto circuito
- 9 fasi di ricarica
- floating system
- funzione SHOW ROOM (13.8V - 12A)
- funzione SUPPLY (14V - 12A)
- funzione memory saver (13.8V - 12A)
- funzione recupero batterie
- porta pinze
- gancio di fissaggio reclinabile
- inclusi accessori: cavo con pinza, cavo con occhielli



**Novità**

#### DATI TECNICI

Alimentazione: 220-240V  
 Potenza: 240W  
 Corrente di carica: 4-16A  
 Tipo batterie: Agm - Wet - Lithium (LiFePo4)

Capacità di carica: 5-360Ah  
 Capacità di mantenimento: 5-550Ah  
 Tensione in uscita: 12-24V  
 Tensione minima batteria: 0,8V  
 Grado di protezione: IP20

014980126 2 kg

€ 385,00 € 222,00

## 961P6

### Videoscopio elettronico con sonda flessibile

Permette di vedere e registrare video o singole immagini direttamente sullo strumento.  
 Include 1 specchietto e 1 magnete



- Schermo TFT LCD 3.2"
- Supporta l'utilizzo di SD CARD (8 GB)
- Supporta memorie flash (8 GB)
- Memoria interna da 64M
- Uscita TV-OUT
- Supporta i formati video (MP4, AVI, 3GP)
- 4 led di illuminazione
- Alimentazione tramite presa USB (batteria incorporata)



#### CARATTERISTICHE TECNICHE

- Pixel del sensore: 640x480
- Risoluzione massima: 320x240
- Lunghezza sonda: 1 mt.
- Diametro camera: 6 mm
- Formati video: MPEG4, 3GP, AVI, ASF.
- Formati foto: JPEG
- Angolo di ripresa: 0÷180°
- Uscita dati: cavo USB e SD card
- Alimentazione: batteria 3,7V 2000 mAh

009610000 2 kg

€ 614,00 € 349,00

## 1498/8A



### Caricabatterie elettronico

- protezione di inversione di polarità, corto circuito
- display digitale retroilluminato
- gancio di fissaggio reclinabile
- funzione recupero batterie scariche
- funzione alimentatore 13,8V-5A



Tensione di alimentazione	220V-240V
Frequenza	50-60 Hz
Corrente nominale (Min-Max)	2-8 Amp
Tensione della batteria	12V
Capacità batteria	5Ah-160Ah
Grado di protezione	IP65
Tipo di batteria	Wet-Gel-Dry-AGM

014980108 1,2 kg

€ 182,00 € 103,50



## 1760PA/AC-DC

### Pinza amperometrica e multimetro digitale

PARAMETRI RILEVABILI  
 Tensione DC: 0.1mV ÷ 600V  
 Tensione AC: 0.1mV ÷ 600V  
 Corrente DC: 0.01A ÷ 1000A  
 Corrente AC: 0.01A ÷ 1000A  
 Resistenza: 0.1Ω ÷ 40MΩ  
 Capacità: 0.001nF ÷ 40 μF  
 Frequenza: 0.001kHz ÷ 4kHz  
 Temperatura: -40°C ÷ 1000 °C  
 -40°F ÷ 1832°F



017600000 660 g

€ 270,00 € 155,00



## 1760/IR500

**Novità**

Termometro digitale ad infrarossi con doppio puntamento laser

**DATI TECNICI**

Range temperatura:  $-50 \div 500 \text{ }^\circ\text{C}$  ( $-22$  a  $932 \text{ }^\circ\text{F}$ )  
 Risoluzione display: 0,1  
 Emissività: regolabile 0,1 ÷ 1  
 Precisione:  $-50$  a  $20 \text{ }^\circ\text{C}$  ( $\pm 3 \text{ }^\circ\text{C}$ );  $20 \div 500 \text{ }^\circ\text{C}$  ( $\pm 2\%$  o  $2 \text{ }^\circ\text{C}$ )  
 Risoluzione ottica (D:S): 12:1  
 Auto Spegnimento: circa 10 secondi  
 Temperatura di funzionamento:  $0 \div 50 \text{ }^\circ\text{C}$   
 Temperatura di stoccaggio:  $-20 \div 60 \text{ }^\circ\text{C}$   
 Alimentazione: 1 batteria 9 V

**500°C**



017600350 350 g

€ 130,00 € 75,00



## 1497/C23

Assortimento 23 utensili elettrici per sblocco connettori elettrici



014970200 1,5 kg

€ 185,00 € 105,00

## 1498TB/12-24

Tester digitale per batteria 12V e analizzatore sistema di avviamento e ricarica 12-24V

Permette di effettuare i seguenti test: batteria, alternatore (intelligente e normale), avviamento, ripple di diodo e prova di messa a terra

- dotato di software per stampare il test eseguito da PC
- display retroilluminato
- struttura compatta e antiurto
- dotato di un apposito ingresso per il collegamento di una mini stampante estraibile (accessorio opzionale Beta 1498ST/TB)



**Display retroilluminato**



**Software in 10 lingue**

Applicazioni	- Test batterie 12V - Test alternatore 12-24V - Test sistemi avviamento
Intervallo di funzionamento	100-2000 CCA
Normative di riferimento	CCA,SAE,DIN,EN,IEC,JIS
Batterie supportate	PB, WET, GEL, AGM, AGM FLAT, EFB
Voltmetro	9V-36V
Lunghezza cavi	1600 mm
Lingue	Italiano, Inglese, Francese, Tedesco, Spagnolo, Polacco, Rumeno, Olandese, Svedese e Finlandese
Accessori inclusi	Cavo USB e Software

014980401 1,5 kg

€ 552,00 € 315,00



435x320x100 mm



## 1498LT/12



**Avviatore portatile ultraleggero ad alte prestazioni**

Include funzione salva memorie



4000A

**Solo 2,5 kg!**

Tensione di utilizzo	12V
Amperaggio continuo	800A
Amperaggio massimo di avviamento	2000A
Amperaggio di picco	4000A
Lunghezza cavi	500 mm
Tipo batteria	4 celle LifePo4
Funzione Salva memoria	Si
Dimensioni	260x135x72 mm

Dotato di alimentatore di ricarica 12 V 1,3A

014980012 3,4 kg  
 € 699,00 € 399,00



## 1498/24



**Avviatore portatile per auto e veicoli commerciali 12-24 V**

- corrente di spunto 4200 A (12 V), 2100 A (24 V)
- batteria ermetica al piombo electrolyte solido (AGM)



014980490 17 kg  
 € 1.160,00 € 656,00

## 1498MN/12



**Avviatore d'emergenza portatile multifunzione per auto e motocicli**

Dotazione:

- cavo di avviamento con pinze isolate e diodo di protezione
- caricabatteria da rete
- caricabatteria da auto
- cavo USB con adattatori di carica
- max 2.000 cc



corrente di picco	600A
uscita USB	5V 1A-2A
dimensioni	190x85x35 mm
uscita per avviamento	12 Volt



240x185x60 mm

014980000 542 g  
 € 299,00 € 172,00

## 1498/40A



IP 65  
 Pb Wet, Gel, Dry, Agm

**Caricabatterie avviatore multifunzione 12-24V carrellato**

Non avendo una batteria interna, la funzione di avviamento (max 350A) non sostituisce quella di un avviatore specifico tipo 1498LT/12 (2000A)

- 3 cicli di carica programmati e 1 ciclo manuale
- potenziometro di regolazione elettronica
- processi specifici di carica WET-SPIRAL/GEL-AGM
- sistema di controllo e protezione elettronico
- processo di carica a 10 fasi
- funzione desolfatazione e recupero batteria
- funzione supply
- doppia tensione 12-24V
- idoneo anche per batterie Start&Stop
- pinze professionali in ottone isolate in gomma



Alimentazione	230V
Tensione in uscita	12-24V
Corrente di carica	1-40A
Corrente di avviamento	350A max cc
Capacità di ricarica	4-450Ah

014980140 8,5 kg  
 € 970,00 € 560,00

800 mm  
 280 mm  
 300 mm





# Carrello multifunzione

Utilizzabile come postazione mobile per strumenti di diagnosi, laptop, tester e caricabatterie.

- Struttura in lamiera verniciata: massima stabilità e solidità
- Maniglia ergonomica • 2 ruote posteriori fisse Ø 160 mm • 2 ruote anteriori girevoli Ø 125 mm (una con freno)

## CA49-G

Carrello multifunzione con antina, vuoto

049000112 36,5 kg

€ 635,00 € 367,00

## CX49-G

Carrello multifunzione, vuoto

049000102 36 kg

€ 568,00 € 325,00



Piano di appoggio superiore su 2 livelli

Ripiani centrali con posizione regolabile e ripiano basso fisso



Cassetto estraibile per mini tastiera



4 utili avvolgicavo laterali in plastica



1 portacarta



1099 mm  
460 mm  
435 mm



2 pratici contenitori laterali

## 1897

Sabbiatrice da banco professionale

Dotazione:

- porta di carico con chiusura a magneti
- piano in lamiera forata
- attacco standard per aspiratori Ø 36 mm
- finestra di visualizzazione in policarbonato protettivo da 6 mm
- illuminazione con lampada a LED
- circuito pneumatico (entrata aria compressa)
- pistola di sabbatura con funzionamento a grilletto



MADE IN ITALY

018970066 38 kg

€ 2.830,00 € 1.580,00

Dimensioni utili cabina	600x520x320 mm
Dimensioni di ingombro	660x530x500 mm
Piano lavoro	Lamiera forata
Illuminazione	LED
Consumo aria	340 l/min a 7 atm
Alimentazione	220 V - 50 Hz

## 1897/KSA

Sabbiatrice da banco articolo 1897 completa di aspiratore articolo 1871M/AS



60 l/s  
35 l

Classe M

018970660 49 kg

€ 3.830,00 € 2.140,00

## 1897/CRB Novità

Corindone

per sabbiatrice 1897 in sacco da 25 kg



018970101 25 kg

€ 142,00 € 78,00

## 1897/MV Novità

Microsfere di vetro

per sabbiatrice 1897 in sacco da 25 kg

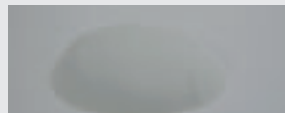

018970103 25 kg

€ 187,00 € 102,00

## 1897/G Novità

Garnet

per sabbiatrice 1897 in sacco da 25 kg



018970104 25 kg

€ 114,00 € 62,50

# 1465

**Novità**

## Strumento di verifica dell'efficienza del motore

Permette di verificare in pochi secondi la compressione dei motori endotermici senza doversi collegare al motore, prelevando l'alimentazione dalla batteria del veicolo, attraverso un software dedicato

### DATI TECNICI

Tensione di funzionamento: 12V DC (batteria veicolo)

Lunghezza cavo pinze: 1300 mm

**Verifica la compressione in pochi secondi!**

1° Fase	calcolo giri/motore
2° Fase	analisi andamento tensione batteria durante ogni singolo giro
3° Fase	visualizzazione potenza elettrica assorbita e compressione relativa calcolata attraverso il lavoro del motorino di avviamento per ogni pistone
4° Fase	verifica stato di carica ed efficienza della batteria



014650010 365 g

€ 965,00 € 558,00

**MADE IN ITALY**

# 1760/RSE

**Novità**

## Rilevatore di segnale

Permette di testare l'alimentazione di componenti come:

- elettroiniettori Common Rail
- elettroiniettori benzina/GPL
- iniettori piezoelettrici
- elettrovalvole regolatrici flusso/elettrovalvole EGR
- bobine e altri

Per effettuare la diagnosi dei singoli componenti dell'impianto elettrico è sufficiente avvicinare la sonda al componente in esame.

In impianti con componenti elettromeccanici/elettronici comandati da una centralina, lo strumento permette di verificare se:

- la centralina di gestione è alimentata e assolve il suo compito di comando
- il cablaggio della centralina al componente è efficiente
- il componente in esame non è interrotto
- il componente non è in cortocircuito
- il componente è elettronicamente funzionante

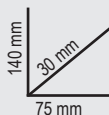

017600170 365 g

€ 380,00 € 220,00

**MADE IN ITALY**





## 1464T

Tester digitale per la misurazione di pressione e compressione



CARATTERISTICHE

- display touch screen da 5"
- batteria ai polimeri di litio ricaricabile
- completo di sensore da 80 bar (basse pressioni) e cavo USB

014640050 1,1 kg

€ 720,00 € 413,00



## 1464PB



Set di 9 connessioni per la verifica della bassa pressione carburante (da utilizzare con 1464T)

Attraverso le connessioni rapide collegate al tester 1464T si effettua rapidamente la verifica della bassa pressione carburante nei motori diesel e benzina



530x440x120 mm

014640700 3,8 kg

€ 440,00 € 254,00



## 1464IC



Set di finti iniettori e finte candele per 1464T

Permette di collegarsi al motore per la verifica della compressione nei motori diesel con tester digitale 1464T



- n° 22 false candele
- n° 5 falsi iniettori
- n° 1 kit falso iniettore universale per truck, motori marini e macchine agricole

014640350 4,5 kg

€ 480,00 € 278,00

559x312x50 mm



## 960AD/TP2



Set di adattatori per 1464T

- finti iniettori
- finte candele
- adattatori candela
- adattatori tappi olio
- raccordi iniezione benzina
- set guarnizioni di ricambio



430x310x50 mm

009600510 3,7 kg

€ 427,00 € 245,00



## 1464AP



Set per la verifica dell'impianto alta pressione dei motori diesel Common rail, con 1464T

- set tubi alta pressione
- raccordi di collegamento
- sensore da 2.000 bar



430x310x50 mm

014640450 1,8 kg

€ 650,00 € 375,00



## 1464VD

**Novità**

### Set per verifica della depressione/vuoto per 1464T

Permette la misurazione e memorizzazione del valore massimo della depressione.

Fornito con:

- sensore da 800 mbar
- adattatori da 6 e 8 mm
- cavo RJ45 da 3 metri

#### DATI TECNICI

test del vuoto: 0÷800 mbar  
risoluzione: 1 mbar  
memorizzazione del valore massimo

240x210x50 mm



014640570 317 g

~~€ 159,00~~ € 92,00



## 1464FAP

**Novità**

### Set per la verifica della pressione del filtro antiparticolato DPF per 1464T

Fornito con:

- sensore da 500 mbar
- adattatore da 8 mm con attacco rapido e raccordo a T
- cavo RJ45 da 3 metri

#### DATI TECNICI

test della pressione: 0÷500 mbar  
risoluzione: 1 mbar

240x210x50 mm



014640610 328 g

~~€ 159,00~~ € 92,00



## 1464ADB

### Set per la verifica della pressione dell'impianto AdBlue® per 1464T

Fornito con adattatori da utilizzare con il sensore standard da 80 bar presente nel 1464T

240x210x50 mm

014640620 237 g

~~€ 74,00~~ € 42,50



## 1880ADB

### Pompa rotativa per AdBlue®

- 5 litri erogati ogni venti rotazioni
- prolunghes per fusti fino a 1,20 m
- 1 attacco per fusti passo fine
- 1 attacco per fusti passo grosso

**Novità**



018800101 1,95 kg

~~€ 108,00~~ € 62,50

## 1759HD/3

### Strumenti per controllo tenuta impianto di raffreddamento e riempimento circuito

Permette di verificare sotto pressione le perdite del circuito (tubi, giunti, pompe, radiatori) e riempire velocemente il circuito evitando la formazione di bolle d'aria.

600x500x140 mm



017590063 6,8 kg

~~€ 472,00~~ € 274,00





## 960KPC

14"

**Estrattore reversibile ad impulsi con coppia regolabile per candele di preriscaldamento**

- l'estrattore pneumatico a coppia regolabile e le bussole speciali consentono di svitare le candele bloccate riducendo al minimo il rischio di danneggiamento
- 5 bussole da 1/4" macchina lunghe, speciali per candele: 8-9-10-11-12 mm, 2 prolunghe e 1 snodo
- 4 coppie di serraggio regolabili: 10-20-30-40 Nm
- regolazione destrorsa e sinistrorsa



009600780 2,9 kg

€ 266,00 € 154,00

420x185x60 mm

## 960EPC/L

**Set di utensili per l'estrazione della punta elettrodo delle candele di preriscaldamento**

M8x1 - M9x1 - M10x1 - M10x1,25

Permette di estrarre la punta della candele quando durante la fase di smontaggio si ha la rottura e la testa rimane inserita nel cilindro

*Versione lunga*

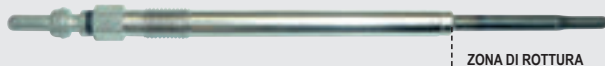

ZONA DI ROTTURA

**Novità**



009600890 2 kg

€ 710,00 € 409,00

## 960KC-M8/M9/M10

**Assortimento di utensili per la rimozione delle candele di preriscaldamento spezzate o danneggiate**

*Per candele con filetto M8-M9-M10*



009600801 2,5 kg

€ 357,00 € 205,00

380x290x50 mm

## 1462/EI

**Attrezzo universale a vibrazione per estrazione iniettori**

- Favorisce la rimozione di iniettori fortemente grippati dall'alloggiamento, senza arrecare danni alla testata ed evitando possibili rotture.
- Utilizzabile con qualsiasi set di estrazione iniettori con o senza massa battente
- L'attrezzo agisce direttamente con vibrazioni e impulsi sul tirante di estrazione, che è accoppiato con l'iniettore
- Attraverso la valvola di regolazione è possibile adeguare l'intensità della vibrazione in base al tipo di intervento da eseguire.

**COMPONENTI**

- 1 adattatore per presa inclinata
- 1 adattatore inclinato
- 1 adattatore per presa ortogonale
- 2 viti
- 1 valvola pneumatica



**Novità**

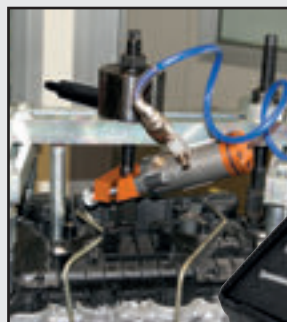

014620240 2,2 kg

€ 538,00 € 309,00

## 1438EVO

### Kit universale per centraggio frizioni

Il kit comprende:

- boccole centraggio su volano  
ø 10-12-14-15-16-17-19-25-27-30 mm
- 1 centratore coperchio frizione
- 2 coni di centraggio disco frizione
- 3 perni guida filettati
- 2 centratori ad espansione  
ø 15÷19 mm  
ø 20÷27 mm

**Componenti  
interamente in metallo**

**Novità**



014380011 1,9 kg

€ 190,00 € 110,00

290x200x60 mm

## 960/C6

### Chiavi esagonali con attacco quadro femmina 3/8" per la rimozione/installazione dei sensori di temperatura gas di scarico

Incluse nel kit:

- 3 misure in versione corta 13,14,17 mm
- 3 misure in versione lunga 13,14,17 mm

**Elevata  
resistenza**

**Novità**



009600055 800 g

€ 65,00 € 37,50

## 1462/KI

### Assortimento utensili per estrazione iniettori Diesel Common Rail

Permette la rimozione degli iniettori DELPHI-BOSCH-SIEMENS-DENSO

- funzionamento meccanico e idraulico
- include un martinetto idraulico da 12 tonnellate
- può essere utilizzato direttamente sul veicolo con motore montato
- le numerose possibilità di regolazione sulla testata permettono di lavorare sulla maggior parte dei motori in circolazione

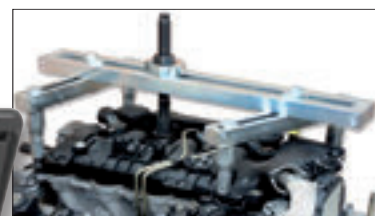

014620235 20 kg

€ 2.065,00 € 1.188,00

530x470x140 mm







# 1895G

MADE IN ITALY

**Novità**

## Generatore di comando per elettroiniettori (benzina e GPL) ed elettrovalvole

Permette di testare in completa autonomia l'efficienza di componenti come:

- elettrovalvole EGR
- elettroiniettori di motori benzina e GPL
- elettrovalvole regolazione turbina a geometria variabile
- compressori per climatizzatori di nuova generazione



### VANTAGGI

- Permette di capire se il componente è meccanicamente funzionante
- In abbinamento a vasche ad ultrasuoni rende più efficace la pulizia dei componenti comandando elettronicamente il componente durante la fase di lavaggio
- Nel controllo dei climatizzatori è indispensabile per stabilire l'efficienza del compressore e della sua valvola regolatrice

### CARATTERISTICHE TECNICHE

Comando iniettori benzina e GPL:

- numero uscite: 4
- durata test: 1-60 s
- tempo apertura: 5-10 ms
- regolazione frequenza impulso: 1-10 Hz

Comando dispositivi PWM:

- numero uscite: 1
- durata test: 1-60 min
- automatico o manuale
- regolazione duty cycle: 10%-85%
- regolazione frequenza segnale: 120-250 Hz

Include 4 connettori con terminali faston femmina

Alimentazione: 110-220 V

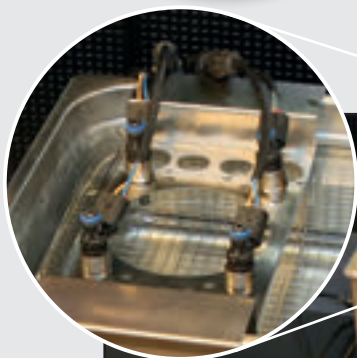

018950800

4 kg

€ 1.530,00 € 885,00

# 1497/C94

Assortimento di 94 connettori per test su autovetture. Utilizzabili con i principali strumenti di diagnosi e con 1895G

**Compresi 2 rubacorrente**



Inclusi nell'assortimento:

- 2 rubacorrente
- 2 potenziometri
- 2 spie di segnalazione
- 2 connettori SRS
- 2 coccodrilli
- 2 sonde ad ago
- 2 puntali
- 2 connettori a banana doppi
- 4 connettori a banana singoli
- 24 terminali maschio piatti 0.6÷6 mm
- 12 terminali maschio tondi 1.6÷3.9 mm
- 24 terminali femmina piatti 0.6÷6 mm
- 12 terminali femmina tondi 1.6÷3.9 mm

014970300

3 kg

€ 325,00 € 185,00

430x390x100 mm

# 1895

## Vasca di lavaggio ad ultrasuoni con funzione speciale di degassificazione

- Attraverso il riscaldamento del liquido e con l'azione degli ultrasuoni permette di pulire efficacemente parti di ricambio e pezzi metallici in genere (iniettori, carburatori, valvole, ecc...)
- Display digitale con regolazione della temperatura e del tempo di lavaggio
- Doppia funzione lavaggio: "soft" e "normal"
- Per una pulizia generale è sufficiente usare acqua ad una temperatura di 50/60°C
- Per una pulizia più accurata aggiungere soluzioni detergenti non schiumogene (tipo Arexons Fulcron Extra) specifiche per vasche ad ultrasuoni
- La funzione degassificazione accelera la liberazione d'aria in tutto il volume della vasca aumentando l'efficacia degli ultrasuoni



### 1895 6    1895 13    1895 27

Capacità vasca	6 litri	13 litri	27 litri
Rubinetto di scarico	✓	✓	✓
Potenza	150 Watt	300 Watt	500 Watt
Potenza di riscaldamento	300 Watt	400 Watt	500 Watt
Regolazione temperatura	0÷80°C	0÷80°C	0÷80°C
Regolazione tempo di lavaggio	0-99 minuti	0-99 minuti	0-99 minuti
Frequenza	40 kHz	40 kHz	40 kHz
Alimentazione	220/230V	220/230V	220/230V
Dimensioni	330x180x310 mm	350x325x320 mm	530x330x380 mm
Dimensioni serbatoio	300x155x150 mm	325x235x145 mm	500x300x200 mm



**Ideale per iniettori e valvole EGR**



## 1895 6 6 litri

018950060    8,1 kg  
€ 586,00    € 339,00

## 1895 13 13 litri

018950130    12,5 kg  
€ 908,00    € 520,00

## 1895 27 27 litri

018950270    13,5 kg  
€ 1.265,00    € 718,00

## 1895/S

### Supporto regolabile per vasche ultrasuoni 1895

Permette il corretto posizionamento degli iniettori durante la fase di lavaggio all'interno della vasca ultrasuoni

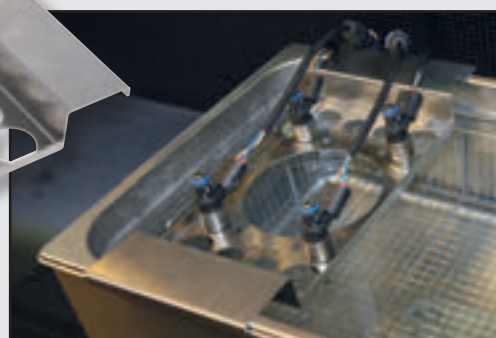
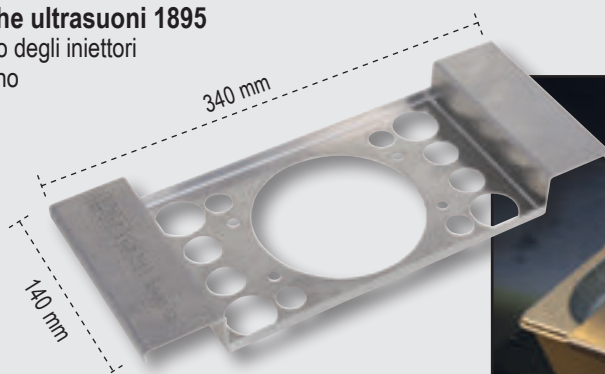

018950501    410 g  
€ 89,00    € 51,00

**Novità**





# 1885/KF

MADE IN ITALY

**Novità**

## Stazione per la manutenzione del cambio automatico

Permette di effettuare in totale sicurezza, con una procedura semplice e guidata, l'intero ciclo di lavaggio e sostituzione olio in tutte le trasmissioni automatiche.

Previene il danneggiamento derivante dall'usura dell'olio contenuto nel cambio automatico, prevenendo in modo pratico e veloce malfunzionamenti caratteristici come: rumorosità eccessiva del cambio, marce bloccate, bruschi innesti delle marce, allungamento dei tempi di cambiata.

### CARATTERISTICHE FUNZIONALI

- Funzionamento automatico
- Procedura guidata passo passo con banca dati integrata
- Compensazione della quantità dell'olio immesso con la stessa quantità di olio esausto, garantendo la presenza costante della corretta quantità di olio nell'impianto
- Flussimetro per controllo visivo della qualità dell'olio
- Stampa di ogni operazione effettuata

### CARATTERISTICHE AUTOMATICHE

- Immissione solvente (facoltativo)
- Lavaggio impianto cambio
- Svuotamento olio coppa
- Svuotamento olio convertitore
- Immissione olio convertitore

### CARATTERISTICHE TECNICHE

- Alimentazione: 220 V 50 Hz
- Visori olio retroilluminati con n. 2 LED luce bianca
- Bilance elettroniche n. 2
- Bilance elettroniche risoluzione +/-10 g
- Scheda elettronica con display grafico retroilluminato
- Cassetto con adattatori in modulo morbido
- Sono disponibili come optional oltre 25 adattatori specifici per cambio



Include adattatori per i cambi più diffusi

**Banca dati con oltre 16.000 modelli di auto**



Incluso nella dotazione della stazione di manutenzione, viene fornito un kit composto da:

- 12 Litri di lubrificante per trasmissioni Motul ATF VI
- 500 ml di additivo per la pulizia interna della trasmissione

**Totalmente automatica**

018850040 70 kg

€ 7.200,00 € 3.960,00



# 1893

MADE IN ITALY

**Novità**

## Stazione automatica di ricarica climatizzatori

Modello completamente automatico, con banca dati auto/autocarri con quantità gas, quantità e tipo olio compressore, software di autodiagnosi per operazioni di manutenzione ordinaria. La banca dati è aggiornabile via software. La macchina può operare in modalità manuale (con presidio umano fase per fase) oppure in modalità completamente automatica (senza presidio).

### CARATTERISTICHE FUNZIONALI

- Funzionamento automatico
- Banca dati auto/autocarri con quantità gas, quantità e tipo olio compressore
- Recupero automatico del gas dalla tubazione
- Compensazione della ricarica della quantità di gas contenuto nelle tubazioni
- Scarico automatico dei gas non condensabili
- Segnalazione automatica di anomalie e manutenzione
- Manometri ø 80 mm
- Vacuometro digitale

### CARATTERISTICHE TECNICHE

- Serbatoio gas: 15 kg
- Pompa vuoto: 75 l/min
- Bilancia elettronica: 50 kg
- Scheda elettronica con display retroilluminato
- Velocità di recupero: 500 g/min
- Alimentazione: 220 V



**Gas R134A**

**1893/134A**

018930001 70 kg  
~~€ 5.130,00~~ € 2.820,00

incluso tracciante R134A (250 ml)



**Gas R1234YF**

**1893/1234YF**

018930012 70 kg  
~~€ 5.300,00~~ € 2.950,00

incluso tracciante R1234YF (250 ml)



# 1893TR/CI

Tracciante per compressori ibridi

**Novità**



018930903 300 g  
~~€ 42,50~~ € 24,50

# 1879 6

Aspiratore liquidi manuale da 6 litri

- 3 tubi rigidi collegabili fra loro
- 1 tubo flessibile specifico per spurgo olio freni

**Novità**



018790000 3,7 kg  
~~€ 180,00~~ € 104,00



# Recuperatori olio

- indicatore di livello
- coppa di grande diametro con griglia scolafiltro capacità 12l
- svuotamento pneumatico del serbatoio con tubo da 1,8 m
- vaschetta portautensili

## 1877

Recuperatore olio esausto carrellato con serbatoio da 90 litri



018770008 23 kg  
 € 580,00 € 329,00

## 1877A

Recuperatore/aspiratore olio esausto, carrellato con serbatoio da 90 litri e precamera

- precamera trasparente capacità 9,5 l
- tubo aspirazione da 1,8 m

In dotazione:

- 1 sonda rigida Ø 5x700 mm
- 1 sonda flessibile Ø 5x700 mm
- 1 sonda rigida Ø 6x600 mm
- 1 sonda flessibile Ø 6x700 mm
- 1 sonda flessibile Ø 7x700 mm
- 1 sonda flessibile Ø 8x700 mm
- adattatori per VW, BMW, CITROËN, MERCEDES



018770080 29,5 kg  
 € 1.025,00 € 589,00

## 1493/C7

38<sup>mm</sup> 16 mm

Chiave autoregolabile a tre bracci per filtri olio destrorsa-sinistrorsa, con bracci intercambiabili

2 serie di bracci:

- 1 serie con lunghezza utile 20 mm
- 1 serie con lunghezza utile 38 mm

*Finitura diamantata antiscivolo*



210x150x50 mm

014930079 600 g  
 € 94,00 € 54,00

Ø mm  
 50÷100

**1490F** 38" 12"

Chiavi a fascia per filtri

**Novità**

Ø Max: 200 mm

014900201 250 g

~~€ 22,00~~ € 12,50



**1493H** 38" 12"

Chiave autoregolabile a tre bracci per filtri olio destrorsa-sinistrorsa

Griffe godronate

**Novità**

014930077 550 g

~~€ 23,00~~ € 13,20



**1493VW** 12"

Chiave per filtri gasolio gruppo VAG e Volvo

**Novità**

014930086 130 g

~~€ 14,00~~ € 8,00



**1494BMW** 38"

Chiave speciale in plastica per tappi olio motori BMW

● 10 mm  
○ 17 mm

**Novità**

014940315 30 g

~~€ 11,50~~ € 6,50



**1494FPC** 38"

Chiave speciale in plastica per tappi olio, motori Ford, Peugeot, Citroën

○ 17 mm

**Novità**

014940320 40 g

~~€ 13,00~~ € 7,50



**1494VW/K**

Kit per sostituzione olio motore gruppo VAG

Contenuto del kit:

- 1 chiave speciale per tappi in plastica
- 6 tappi in plastica per coppa

**Novità**

014940310 120 g

~~€ 23,00~~ € 13,30



**1491A** **Novità**

Pinza regolabile per filtri olio

Regolazione di precisione mediante cremagliera

Ø min: 55 mm  
Ø Max: 140 mm

014910040 620 g

~~€ 26,00~~ € 15,00



**1491T** **Novità**

Pinza regolabile per filtri olio truck

Regolazione di precisione mediante cremagliera

Utilizzabile per filtri essiccatori

Ø min: 70 mm  
Ø Max: 200 mm

014910050 1,5 kg

~~€ 61,00~~ € 35,00





## 1758

### Imbuto autoadattante

Particolarmente utile per auto prive di profondità all'interno del tappo di carico



017580020 400 g  
~~€ 45,00~~ € 25,80

## 1758B

### Imbuto antiriflusso con attacchi rapidi

Particolarmente indicato per vetture gruppo VAG

**Novità**

**Antiriflusso**



017580030 500 g  
~~€ 30,00~~ € 17,00

## CB52-0

### Carrello per cambi/trasmissioni con recupero liquidi

Il piano inclinato e i fori di scolo permettono il recupero dei liquidi direttamente nella vaschetta di raccolta

- Dotato di:
- 4 ruote girevoli di cui 2 con freno
  - cassetto per utensili
  - vaschetta di raccolta liquidi estraibile in PE con capacità 7 litri
  - 2 ripiani



052000201 60 kg  
~~€ 532,00~~ € 299,50

## 1756G

**Novità**

### Siringa per gasolio, capacità 1,5 l

Utilizzabile per:

- riempimento filtri gasolio
- riempimento serbatoio cerina

Compresi nel kit:

- 2 tubi con attacchi rapidi femmina per collegamento tubi gasolio
- 2 attacchi rapidi maschio in metallo
- 1 adattatore conico per tubi gomma

1500 ml



017560615 850 g  
~~€ 98,00~~ € 56,50

## Siringhe per olio in polipropilene

- Temperatura di funzionamento: +0 / +50°C
- Non adatta per carburanti e oli minerali
- Adatta anche al liquido impianto freni

200 ml

Doppia guarnizione in EPDM



017560502 250 g  
~~€ 28,50~~ € 16,50

1500 ml

Doppia guarnizione in NBR



017560515 690 g  
~~€ 64,00~~ € 37,00

## 1884

### Attrezzo per l'inserimento di olio nei cambi manuali, automatici e nei differenziali

Completo di 12 adattatori per la connessione diretta

- dotato di valvola di non-ritorno per un'efficace azione di inserimento dell'olio senza perdite
- portata: 70 cc a pompata
- capacità serbatoio: 7,5 litri
- massima viscosità olio utilizzabile: SAE 140



12 ADATTATORI

FORD	AT-101
UNIVERSAL (Bmw, Honda, Nissan...)	AT-102
VW-AUDI	AT-103
VW-AUDI-PORSCHE	AT-104
VW-AUDI-MINI COOPER	AT-105
MERCEDES	AT-106
DSG	AT-107
VW-AUDI CVT	AT-108
VOLVO	AT-109
TOYOTA-LEXUS	AT-110
SKODA	AT-111
VW Passat/Tiguan <2007	AT-112

018840010 4,8 kg  
~~€ 398,00~~ € 229,00

## 1466/C5

### Kit 5 chiavi per spurgo freni

Inclusi nel kit:

- 5 chiavi misura 7-8-9-10-11 mm
- 1 tubo di scarico con valvola di non ritorno

L'olio passa all'interno della bussola

260x170x50 mm



014660100 700 g  
~~€ 105,00~~ € 61,50

## 1485TC

**Novità**

Leva per il tensionamento delle cinghie dei servizi, montate su motori Ford, PSA, FCA



014850330 680 g  
~~€ 39,00~~ € 22,50

## 1472MT/VW

**Novità**

Coppia di graffe per scollegamento collettori di aspirazione gruppo VAG

Utilizzabile su motori turbo benzina 1.0 - 1.2 - 1.4



014720500 100 g  
~~€ 9,50~~ € 5,50

## 1466L 11

**Novità**

Chiave 11 mm per spurgo freni versione lunga

Versione lunga



014660211 90 g  
~~€ 26,00~~ € 15,00

## 1466TLF

Tanica per recupero olio freni capacità 1,5 litri

Attacco rapido per tubo di spurgo ø 5,5 mm



**Novità**

014660201 300 g  
~~€ 38,00~~ € 22,00

## 1482D

Pinza con prolunga flessibile per raccordi rapidi tubi carburante

**Novità**



014820026 500 g  
~~€ 69,00~~ € 39,50





## 989A

**Pinza per la rimozione dei piombi adesivi di equilibratura ruote**  
 Profilo dei becchi appositamente studiato per una rimozione dei piombi senza contatto col cerchione

*Nessun rischio di danneggiamento*

**Novità**

009890011 400 g  
~~€ 27,00~~ € 15,50

## 720LC/C3

**3 chiavi a bussola Macchina con inserti polimerici per dadi ruote**  
 in valigetta di plastica  
 Ø: 17 - 19 - 21 mm

148x132x44 mm

007200653 800 g  
~~€ 33,00~~ € 19,00

## 1471M/C22

**Utensile pneumatico per arretrare e ruotare i pistoncini dei freni a disco destrorsi e sinistrorsi con accessori**

- martinetto automatico
- 150 kg di spinta
- pressione di utilizzo 5-8 bar

350x310x85 mm

014710101 3,8 kg  
~~€ 252,00~~ € 145,00

## 1567

**Leva per estrazione testine braccio oscillante e ammortizzatori dal montante**  
 Un solo operatore riesce senza sforzo a posizionare la leva e a procedere al disassemblaggio

*È sufficiente applicare una forza di 20 Nm*

015670001 5,5 kg  
~~€ 275,00~~ € 159,00



## 3035

### Carrello trasporta pneumatici

- per trasportare agevolmente pneumatici fino ad un massimo di 980 mm di diametro
- utilizzabile come piano d'appoggio, grazie al blocco della posizione in orizzontale
- 2 ruote Ø 260 mm e 2 ruote Ø 125 mm
- altezza massima trasportabile 1,60 m
- portata massima 200 kg
- forche regolabili in 2 posizioni: 880 e 980 mm



030350100 30 kg

€ 799,00 € 460,00

## 3036

### Base per movimentazione ruote

Ruote in gomma antitraccia

Max 150 Kg



Ø 630 mm

030360063 4,2 kg

€ 94,00 € 54,00



**Novità**





## 1550U

**Smonta ammortizzatori pneumatico per autoveicoli, SUV e veicoli commerciali**

- sistema universale di presa superiore
- sistema di sicurezza attiva sulla molla
- griglia di protezione "full body"



Fornito di 2 staffe inferiori per diametri 78-205 mm

DATI TECNICI

Potenza spinta:

2 ton (10 bar) - 1.6 ton (8 bar) - 1.2 ton (6 bar)

Corsa di compressione molla: 335 mm

015500010 87,5 kg

€ 2.465,00 € 1.388,00

## 1550U/SS187

**Staffa sinistrorsa per 1550U**

Particolarmente indicata per molle con profilo sinistro tipo Nissan Qashqai e Renault Koleos. Diametro 105-187 mm



015500018 4,4 kg

€ 306,00 € 177,00

## 1550U/M

**Morsa per smonta ammortizzatori 1550U**

Permette il bloccaggio dello stelo dell'ammortizzatore

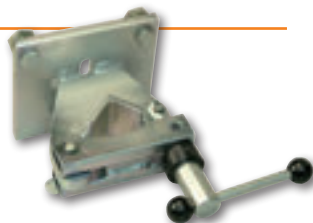

015500021 4 kg

€ 290,00 € 168,00

1670 mm  
610 mm  
825 mm



## 3009

**Carrello per movimentazione veicoli**

Portata massima: 550 kg

- 4 rulli basculanti
- larghezza rulli 200 mm
- per ruote fino a 240 mm di larghezza
- ruote in Vulkollan con cuscinetto



**Ideale per:**

- recupero vetture incidentate su carro attrezzi
- autofficine e carrozzerie
- movimentazione auto all'interno di show room

030090001 21,8 kg

€ 352,00 € 202,00

## 2254F

### Protezione anteriore auto

Permette di proteggere la parte frontale del veicolo lasciando le aperture per i fari e il radiatore

- Lavabile
- Impermeabile e resistente ad oli e grassi
- Fissaggio tramite lacci
- Materiale: 98% poliammide/nylon, 2% poliuretano



022540150 800 g

~~€ 70,00~~ € 40,50

## 2254SV

### Protezione riutilizzabile per sedile e volante

Adatta alla maggior parte dei sedili e volanti di autoveicoli

- Misura unica
- Riutilizzabile e lavabile
- Realizzata in resistente tessuto di nylon con cordonatura elasticizzata
- Materiale: 98% poliammide/nylon, 2% poliuretano



022540100 170 g

~~€ 22,00~~ € 12,80

## 1360/KP3

**Novità**

### Martelli con teste sferiche e penna a punta più punzone, in materiale plastico

Contenuto del kit:

- 1 martello da 210 g con testa  $\varnothing$  30 mm
- 1 martello da 290 g con testa  $\varnothing$  40 mm
- 1 punzone da 75 g con punta da 5 mm



013600503 580 g

~~€ 67,00~~ € 38,50

## 1365/K13

### Pompa oleodinamica 10 t e kit accessori per carrozzeria in pratica valigia trolley

Inclusi nel kit:

- pompa oleodinamica 10T e pistone
- pinza divarica parafanghi e piastra di appoggio
- base a "L", punzoni e prolungha
- raccordo maschio maschio per montaggio accessori



900x420x180 mm

013650013 33 kg

~~€ 556,00~~ € 313,00

## 1361/C12

**Novità**

### Serie di puntali in Teflon® per carrozzeria

275x160x57 mm



013610012 600 g

~~€ 105,00~~ € 59,50

## 1479ML/S3

**Novità**

### Kit di 3 leverini multifunzione in materiale plastico

Particolarmente adatti per lavori di precisione



014790603 15 g

~~€ 9,00~~ € 5,20







## 3002

### Letto sottomacchina e seggiolino

- struttura in acciaio
- rivestimento in PVC con imbottitura
- possibilità di regolare la posizione rapidamente: lettino o seggiolino



030020001 8 kg  
~~€ 94,00~~ € 54,50

## 3003

### Letto sottomacchina in plastica antiurto

Ø ruote: 76 mm



030030001 5 kg  
~~€ 73,00~~ € 42,00



## 2254T

### Tappeto per protezione ginocchia

Realizzato in EVA antiscivolo



022540047 200 g  
~~€ 24,00~~ € 13,90



## 2250-0

### Seggiolino girevole con vassoio

- Seduta tonda girevole
- Altezza regolabile tramite pistone a gas (410-530 mm)
- 5 ruote pivotanti



2 portaminuterie/portautensili di cui uno regolabile in altezza



022500011 6 kg  
~~€ 85,00~~ € 49,00



## 1498PC

### Stabilizzatore di tensione 12-24 V

Indispensabile per proteggere le centraline in fase di saldatura ed avviamenti con avviatori

**12-24 V**



014980801 300 g  
~~€ 82,00~~ € 47,00

## 3030/2T

### Sollevatore idraulico a 6 ruote

- ottima manovrabilità del sollevatore su pavimentazioni sconnesse e irregolari
- doppie ruote anteriori basculanti in materiale plastico (PTFE)
- il pedale permette un rapido avvicinamento

**Altezza min: 85 mm**  
**Altezza Max: 520 mm**

**Portata: 2 t**



030300020 45 kg

€ 660,00 € 375,00

## 3029L/2T

### Sollevatore idraulico lungo ribassato da 2 tonnellate

- Permette di operare su veicoli con bassa altezza da terra e punto di sollevamento interno
- Velocità di discesa controllata
  - Pedale di avvicinamento rapido
  - Ruote in nylon

**Altezza min: 75 mm**  
**Altezza Max: 530 mm**

**Novità**

**Portata: 2 t**

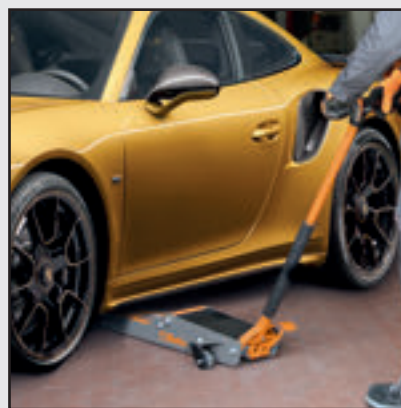

030290120 41 kg

€ 395,00 € 228,00

## 3029/2T

### Sollevatore idraulico ribassato a 4 ruote da 2 tonnellate

- Pedale di avvicinamento rapido
- Struttura in acciaio e ruote in nylon
- Altezza minima 75 mm

**Altezza min: 75 mm**  
**Altezza Max: 500 mm**

**Novità**

**Portata: 2 t**

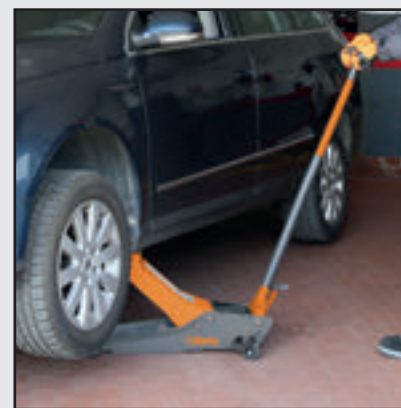

030290020 36 kg

€ 340,00 € 197,00





	3027 20	3027 30	3027 50
Capacità massima	20 t	30 t	50 t
Pompa manuale a 2 velocità	✓	✓	✓
Pistone mobile	✓	✓	✓
Sicurezza idraulica in caso di sovraccarico	✓	✓	✓
Manometro	✓	✓	✓
Serie prismi a V inclusi	✓	✓	✓
Argano	x	x	✓



**Presse idrauliche con pistone mobile**



**3027 20**

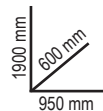

030270020 140 kg  
 € 1.955,00 € 1.115,00

**3027 30**

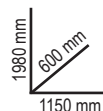

030270030 230 kg  
 € 3.400,00 € 1.950,00

**3027 50**

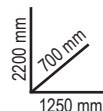

030270050 350 kg  
 € 4.650,00 € 2.680,00



**3027/PR**

**Novità**

**Supporto pressa per estrazione/introduzione mozzi, cuscinetti e silent block**

Sistema universale che, operando sotto pressa, attraverso una base di appoggio e relativi accessori, permette lo smontaggio/montaggio di mozzi, cuscinetti e silent block dalla loro sede. L'attrezzo si adatta alle conformazioni geometriche irregolari dei mozzi/perni fusi sui quali l'operatore deve intervenire.



**Universale**

DATI TECNICI  
 Campo di lavoro: min 130 mm - Max 186 mm  
 Dimensioni: 300 x 300 mm  
 Portata massima: 20 t

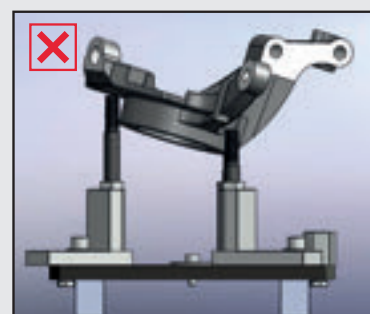
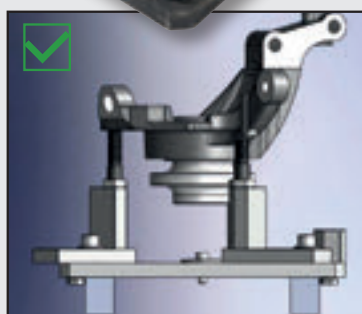

030270400 14 kg  
 € 518,00 € 298,00



## 3025

### Gru idraulica pieghevole con pompa a doppio effetto

- Portata massima 1 t
- la struttura richiudibile riduce al minimo gli ingombri
- 4 posizioni di carico: 450-650-800-1000 kg
- velocità di discesa controllata



1660 mm  
550 mm  
1560 mm

030250001 110 kg  
€ 1.600,00 € 919,00

## 3025/PF

### Pinza movimentazione fusti



70 mm  
550 ÷ 640 mm

Portata massima 300 kg

030250011 10 kg  
€ 255,00 € 146,00

## Sollevatori idraulici da fossa e sottoponte



3026 0,3 3026 0,5 3026 1,0

Portata massima	300 kg	500 kg	1000 kg
Pompa a pedale	✓	✓	✓
Altezza min/Max	1120 - 1970 mm	1140 - 1990 mm	1140 - 1990 mm
Valvola limitatrice di carico	✓	✓	✓

## 3026/SP

### Supporto universale per trasmissioni

- Permette ad un solo operatore di smontare e rimontare le trasmissioni di autovetture, veicoli commerciali e fuoristrada con rapidità e sicurezza.
- Adatto per steli con diametro: 25-30-35-45 mm
- Portata massima: 150 kg



030260505 7,8 kg  
€ 569,00 € 328,00

## 3026 0,3

030260003 24,7 kg  
€ 585,00 € 335,00

## 3026 0,5

030260005 31 kg  
€ 694,00 € 399,00

## 3026 1,0

030260010 37,8 kg  
€ 840,00 € 478,00





**8143** *Novità*

**Paranco manuale a catena**

- Modello professionale, realizzato con materiali di alta qualità
- Freno automatico a doppio salterello
- Gancio girevole con sicura



**EN13157**

**8143 1 t**

WLL t	L m
1	3

081430010	12 kg
€ 200,00	€ 95,00

**8143 2 t**

WLL t	L m
2	3

081430020	20 kg
€ 290,00	€ 139,00

**8146C** *Novità*

**Paranco a leva compatto**

- Modello professionale portatile, leggero e compatto
- Freno automatico a doppio salterello per garantire le migliori condizioni di sicurezza
- Cuscinetti a rulli per una maggiore fluidità e durabilità
- Gancio girevole con sicura



*Leggero, portatile*

**EN13157**

**8146C 0,25 t**

WLL t	L m
0,25	1,5

081460002	2,5 kg
€ 190,00	€ 89,50

**8146** *Novità*

**Paranco a leva**

- Modello professionale, facile da installare e utilizzare
- Freno automatico a doppio salterello per garantire le migliori condizioni di sicurezza
- Cuscinetti a rulli per una maggiore fluidità e durabilità
- Gancio girevole con sicura



**EN13157**

**8146 0,75 t**

WLL t	L m
0,75	1,5

081460008	7 kg
€ 200,00	€ 95,00

**8146 1,5 t**

WLL t	L m
1,5	1,5

081460015	11 kg
€ 285,00	€ 135,00

MADE IN ITALY

Novità

### 11001

Dischi abrasivi da taglio per acciaio  
Esecuzione a centro depresso  
• S = 3,2 mm



110010118  
~~€ 1,22~~ € 0,68

### 11011

Dischi abrasivi da sbavo per acciaio  
Esecuzione a centro depresso  
• S = 6,5 mm



110110115  
~~€ 1,60~~ € 0,90

### 11011H

Dischi abrasivi da sbavo per acciaio, versione rigida  
Esecuzione a centro depresso  
• S = 6,5 mm



110110680  
~~€ 3,15~~ € 1,75

### 11034 1,0

Dischi abrasivi da taglio per acciaio e inox  
Esecuzione di spessore sottile e a centro piano  
• Top Line  
• S = 1,0 mm



110340022  
~~€ 1,32~~ € 0,74

### 11034 1,6

Dischi abrasivi da taglio per acciaio e inox  
Esecuzione di spessore sottile e a centro piano  
• Top Line  
• S = 1,6 mm



110340062  
~~€ 1,32~~ € 0,74

### 11212A

Dischi lamellari con tela abrasiva allo zirconio supporto in plastica e lamella singola  
Esecuzione piana  
• Top Line  
• Grana 40



112120004  
~~€ 2,65~~ € 1,48

### 11214A

Dischi lamellari con tela abrasiva allo zirconio supporto in plastica e lamella doppia  
Esecuzione piana  
• Top Line  
• Grana 40



112140004  
~~€ 2,65~~ € 1,48

### 11216A

Dischi lamellari con tela abrasiva allo zirconio supporto in fibra di vetro e lamella singola  
Esecuzione piana  
• Top Line  
• Grana 40



112160004  
~~€ 2,65~~ € 1,48

### 11230A

Dischi lamellari con tela abrasiva al corindone supporto in plastica e lamella singola  
Esecuzione piana  
• Premium Line  
• Grana 40



112300004  
~~€ 2,16~~ € 1,21

### 11234A

Dischi lamellari con tela abrasiva al corindone supporto in fibra di vetro e lamella singola  
Esecuzione piana  
• Top Line  
• Grana 40



112340004  
~~€ 2,40~~ € 1,34

### 11246A

Dischi lamellari con tela abrasiva ceramicata supporto in plastica e lamella singola  
Esecuzione piana  
• Top Line  
• Grana 40



112460004  
~~€ 4,20~~ € 2,35





12V - 2 Ah

1972/12

Trapano avvitatore ultracompatto 12V

- Ultracompatto: 176 mm
- Ultraleggero: 1,1 kg
- Perfettamente bilanciato
- Doppia velocità con ingranaggi in acciaio e frizione a 18 posizioni
- Coppia fino a 34 Nm e 1500 giri/min (350 giri/min in 1° marcia)
- Impugnatura ergonomica antiscivolo
- LED frontale
- Forniti in valigetta rigida con 2 batterie agli ioni di litio da 2 Ah e caricatore rapido (45 min)



1-10 mm



019720012 1,1 kg  
€ 315,00 € 170,00



1982/12EF

Avvitatore reversibile ad impulsi 12V

- Coppia elevata: 115 Nm
- Elevata velocità: 0-2000 giri/min
- Attacco esagonale da 1/4" con ghiera di bloccaggio
- Ultracompatto: solo 163 mm di lunghezza
- Ultraleggero: solo 1,1 kg con batteria
- Triplo LED di illuminazione frontale
- Forniti in valigetta rigida con 2 batterie agli ioni di litio da 2 Ah e caricatore rapido (45 min)



019820012 1,1 kg  
€ 335,00 € 184,00



18V - 5 Ah

1972/18

Trapano avvitatore a percussione 18V Brushless

- Mandrino da 13 mm in acciaio
- Coppia fino a 75 Nm e 2100 giri/min (550 giri/min in 1° marcia)
- Doppia velocità con ingranaggi in acciaio e selettore per le funzioni di foratura, foratura con percussione e avvitamento con frizione a 20 posizioni
- LED di illuminazione frontale
- Impugnatura laterale in dotazione
- Forniti in valigetta rigida con 2 batterie agli ioni di litio da 5 Ah e caricatore rapido (80 min)



Scatola ingranaggi interamente metallica per migliorare robustezza e durata

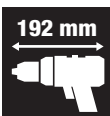

019720018 2,2 kg  
€ 765,00 € 419,00



1984/18QM

Avvitatore reversibile ad impulsi 18V Brushless

- Triplo LED di illuminazione frontale
- 4 modalità selezionabili:
  - 1: 270Nm; 1400 RPM
  - 2: 360Nm; 2000 RPM
  - 3: 450Nm; 2750 RPM
- A: Autostop - fino a che l'avvitatore rileva una rotazione libera applica il massimo della coppia/velocità (450Nm; 2750 RPM). Quando il bullone arriva a fine corsa e non ruota più, l'avvitatore continua ad applicare il massimo della coppia per 1 secondo poi si arresta
- Forniti in valigetta rigida con 2 batterie agli ioni di litio da 5 Ah e caricatore rapido (80 min)



1/2"

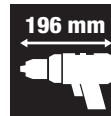

1/2"



019840018 2,3 kg  
€ 898,00 € 492,00



## 1927XM

### Avvitatore reversibile compatto

- Meccanismo impulsivo singolo martello
- Incredibilmente compatto e potente
- Comando d'inversione a pulsante azionabile con una sola mano
- Tre differenti livelli di potenza in avvitamento
- Scarico dell'aria attraverso l'impugnatura
- Gancio per bilanciatore

Velocità libera	giri/min	10.000
Massa battente		Singolo martello
Coppia massima	Nm	770
Capacità vite/dado	Cl 8.8	M22●34 mm
Capacità vite/dado	Cl 12.9	M18●27 mm
Attacco aria	GAS	1/4"
Pressione di utilizzo	bar	6,2
Ø tubo consigliato	mm	10
Consumo aria medio	l/min	122

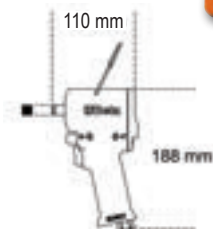

019270030 1,3 kg  
 € 239,00 € 135,00

## 1927XM/K5

### Avvitatore reversibile compatto fornito con 5 bussole Macchina, in valigetta di plastica

720 17-19-21-22-24 mm

307x206x86 mm



019270129 2,8 kg  
 € 293,00 € 168,00

## 1927B

### Avvitatore reversibile

- Meccanismo impulsivo "Pin Clutch"
- Impugnatura in gomma
- Comando d'inversione a leva
- Tre differenti livelli di potenza in avvitamento
- Scarico dell'aria attraverso l'impugnatura

Velocità libera	giri/min	7.000
Massa battente		Pin Clutch
Coppia massima	Nm	705
Capacità vite/dado	Cl 8.8	M22●34 mm
Capacità vite/dado	Cl 12.9	M18●27 mm
Attacco aria	GAS	1/4"
Pressione di utilizzo	bar	6,2
Ø tubo consigliato	mm	10
Consumo aria medio	l/min	133



019270022 2,1 kg  
 € 158,00 € 89,00

## 720ME/C8

### 8 chiavi a bussola Macchina maschio esagonale

5-6-8-10  
 12-14-17-19 mm



007200525 1,7 kg  
 € 124,50 € 72,00

270x120x45 mm

## 1927G

### Avvitatore reversibile compatto

- Meccanismo impulsivo singolo martello
- Corpo motore in alluminio con impugnatura in materiale composito
- Comando d'inversione azionabile con una sola mano
- 3 differenti livelli di potenza in avvitamento
- Scarico dell'aria attraverso l'impugnatura
- Motore in testa con trasmissione diretta della rotazione al quadro d'uscita che permette di ottenere un miglior bilanciamento del corpo aumentando la maneggevolezza

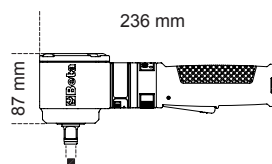

Velocità libera	giri/min	8.500
Massa battente		Singolo martello
Coppia massima	Nm	325
Capacità vite/dado	Cl 8.8	M16●24 mm
Capacità vite/dado	Cl 12.9	M14●21 mm
Attacco aria	GAS	1/4"
Pressione di utilizzo	bar	6,2
Ø tubo consigliato	mm	10
Consumo aria medio	l/min	113

019270050 1,2 kg  
 € 350,00 € 203,00



## 1927P

Avvitatore reversibile in materiale composito

- Meccanismo impulsivo doppio martello
- Leggero e bilanciato per un facile utilizzo
- Comando d'inversione a leva
- Tre differenti livelli di potenza in avvitamento
- Scarico dell'aria attraverso l'impugnatura
- Impugnatura antivibrazioni

Velocità libera	giri/min	7.500
Massa battente		Doppio martello
Coppia massima	Nm	1750
Capacità vite/dado	Cl 8.8	M24 ● 36 mm
Capacità vite/dado	Cl 12.9	M20 ● 30 mm
Attacco aria	GAS	1/4"
Pressione di utilizzo	bar	6,2
Ø tubo consigliato	mm	10
Consumo aria medio	l/min	290

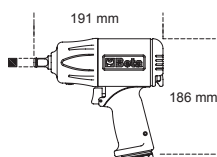

12"



019270008 2 kg

€ 431,00 € 248,00

## 1927P/K3

Avvitatore reversibile in materiale composito fornito con 3 bussole macchina, in valigetta di plastica

Novità



019270118 3,5 kg

€ 470,00 € 267,00

12"

## 1927CD

Avvitatore reversibile in materiale composito

- Meccanismo impulsivo doppio martello
- Leggero e bilanciato per un facile utilizzo
- Dotato di un'elevata coppia
- Comando d'inversione a leva
- Tre differenti livelli di potenza in avvitamento
- Scarico dell'aria attraverso l'impugnatura
- Silenziato

Velocità libera	giri/min	7.000
Massa battente		Doppio martello
Coppia massima	Nm	1020
Capacità vite/dado	Cl 8.8	M22 ● 34 mm
Capacità vite/dado	Cl 12.9	M18 ● 27 mm
Attacco aria	GAS	1/4"
Pressione di utilizzo	bar	6,2
Ø tubo consigliato	mm	10
Consumo aria medio	l/min	130

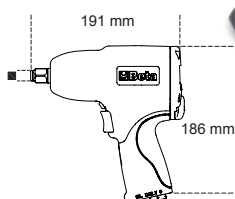

12"



350x305x86 mm

019270007 2,3 kg

€ 370,00 € 199,00

## 1927CD/K3

Assortimento di un avvitatore reversibile e 3 bussole Macchina



720LC 17-19-21 mm

019270107 4 kg

€ 412,00 € 218,00

12"

## 720/C24

Serie di 24 chiavi a bussola Macchina in cassetta di lamiera

N. pezzi/Descrizione	Beta N.
15 10-12-13-14-15-16-17-18 19-21-22-24-27-30-32 mm	720
6 13-17-19-21-22-24 mm	720L
3 17-19-21 mm	720LC

007200904 1,7 kg

€ 345,00 € 194,00



12"



Novità



# 1928XM

**Novità**

3/4"

## Avvitatore reversibile compatto

- Meccanismo impulsivo doppio martello
- Incredibilmente compatto e potente
- Comando d'inversione a pulsante azionabile con una sola mano
- Tre differenti livelli di potenza in avvitamento
- Scarico dell'aria attraverso l'impugnatura



**1.600 Nm**

Velocità libera	giri/min	4.800
Massa battente		Doppio martello
Coppia massima	Nm	<b>1600</b>
Capacità vite/dado	Cl 8.8	M27●41 mm
Capacità vite/dado	Cl 12.9	M24●36 mm
Attacco aria	GAS	3/8"
Pressione di utilizzo	bar	6,2
Ø tubo consigliato	mm	10
Consumo aria medio	l/min	175

**Super compatto e potente**

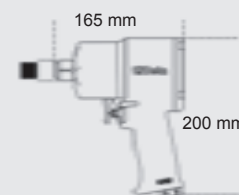

019280030 2,9 kg

€ 470,00 € 265,00

# 1928DA

3/4"

## Avvitatore reversibile

- Meccanismo impulsivo doppio martello
- Robusto e compatto, dotato di un'elevata coppia
- Comando d'inversione a leva
- Tre differenti livelli di potenza in avvitamento e svitamento
- Scarico dell'aria attraverso l'impugnatura
- Impugnatura ergonomica antiscivolo



Velocità libera	giri/min	5.000
Massa battente		Doppio martello
Coppia massima	Nm	<b>1.695</b>
Capacità vite/dado	Cl 8.8	M30●46 mm
Capacità vite/dado	Cl 12.9	M27●41 mm
Attacco aria	GAS	3/8"
Pressione di utilizzo	bar	6,2
Ø tubo consigliato	mm	10
Consumo aria medio	l/min	210

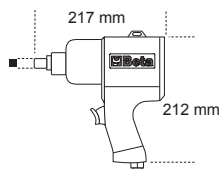

019280022 4,3 kg

€ 695,00 € 399,00

# 1928CD

3/4"

## Avvitatore reversibile

- Meccanismo impulsivo doppio martello
- Robusto e compatto, dotato di un'elevata coppia
- Comando d'inversione a leva
- Tre differenti livelli di potenza in avvitamento e svitamento
- Scarico dell'aria attraverso l'impugnatura
- Impugnatura ergonomica antiscivolo



Velocità libera	giri/min	4.500
Massa battente		Doppio martello
Coppia massima	Nm	<b>1.800</b>
Capacità vite/dado	Cl 8.8	M27●41 mm
Capacità vite/dado	Cl 12.9	M24●36 mm
Attacco aria	GAS	3/8"
Pressione di utilizzo	bar	6,2
Ø tubo consigliato	mm	10
Consumo aria medio	l/min	215

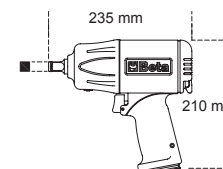

019280007 3,5 kg

€ 888,00 € 507,00





## 1930PA

1"

### Avvitatore reversibile

- Estremamente compatto
- Dotato di maniglia ausiliaria
- Comando d'inversione a leva
- Tre differenti livelli di potenza in avvitamento e svitamento
- Scarico dell'aria attraverso l'impugnatura



Velocità libera	giri/min	3.500
Massa battente		Doppio martello
Coppia massima	Nm	2445
Capacità vite/dado	Cl 8.8	M36 ● 55mm
Capacità vite/dado	Cl 12.9	M30 ● 46mm
Attacco aria	GAS	1/2"
Pressione di utilizzo	bar	6,2
Ø interno tubo aria	mm	13
Consumo aria medio	l/min	350

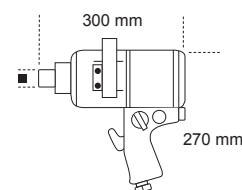

019300032 9,6 kg  
 € 1.035,00 € 589,00

## 1930LH

1"

### Avvitatore reversibile

- Meccanismo impulsivo doppio martello
- Albero da 210 mm (8,3")
- Impugnatura con nuovo design, inclinata di 70° per non affaticare il polso
- Dotato di maniglia ausiliaria laterale
- 3 differenti livelli di potenza in avvitamento e svitamento
- Scarico dell'aria posto nella parte inferiore del corpo



*Ottimo rapporto peso/potenza*

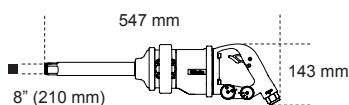

Velocità libera	giri/min	6.000
Massa battente		Doppio martello
Coppia massima	Nm	2.441
Capacità vite/dado	Cl 8.8	M36 ● 55 mm
Capacità vite/dado	Cl 12.9	M30 ● 46 mm
Attacco aria	GAS	1/2"
Pressione di utilizzo	bar	6,2
Ø tubo consigliato	mm	13
Consumo aria medio	l/min	280

019300030 7,1 kg  
 € 1.080,00 € 619,00

## 1930LA

1"

### Avvitatore reversibile

- Meccanismo impulsivo doppio martello
- Albero da 8" (203 mm)
- Dotato di maniglia ausiliaria
- Comando d'inversione a leva
- 3 differenti livelli di potenza in avvitamento
- Scarico dell'aria attraverso l'impugnatura

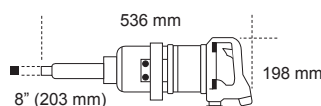

Velocità libera	giri/min	4.000
Massa battente		Doppio martello
Coppia massima	Nm	2.445
Capacità vite/dado	Cl 8.8	M36 ● 55 mm
Capacità vite/dado	Cl 12.9	M30 ● 46 mm
Attacco aria	GAS	1/2"
Pressione di utilizzo	bar	6,2
Ø tubo consigliato	mm	13
Consumo aria medio	l/min	460

019300037 10,6 kg  
 € 1.080,00 € 599,00

## 1937

### Levigatrice rotorbitale palmare senza lubrificazione in composito

- Non necessita di lubrificazione
- Estremamente compatta e maneggevole
- Platorello con velcro a 6 fori, Ø 150 mm
- Regolazione in continuo della velocità del motore
- Impugnatura in morbido materiale antiscivolo
- Predisposta per la connessione a sistemi di aspirazione con raccordo girevole
- Scarico dell'aria orientabile

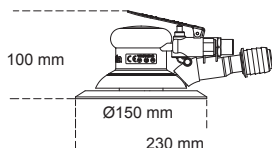

**Diametro orbita**  
**2,5 mm**  
**5,0 mm**

Velocità libera	giri/min	12.000
Potenza	kW	0,18
Dimensione platorello	mm	150
Filettatura albero		5/16"-24
Attacco aria	GAS	1/4"
Pressione di utilizzo	bar	6,2
Ø interno tubo aria	mm	10
Consumo aria medio	l/min	170
Peso	g	860

	Ø Orbita mm	g			
<b>1937 2,5</b>	2,5	860	<b>019370000</b>	<del>€ 379,00</del>	<b>€ 217,00</b>
<b>1937</b>	5,0	860	<b>019370001</b>	<del>€ 379,00</del>	<b>€ 217,00</b>

## Cricchetti reversibili a massa battente

- Meccanismo impulsivo tipo "rocking dog" con doppio martello
- Facilità di serraggio: il sistema a massa battente elimina la torsione del polso a fine avvitatura e riduce i tempi operativi
- Compatto e potente: la coppia massima raggiungibile è notevolmente superiore rispetto a quella ottenibile con un cricchetto tradizionale
- Impugnatura ergonomica in gomma



**68 Nm**



164 mm

### 1922P1 14"

019220006	0,6 kg
<del>€ 249,00</del>	<b>€ 127,00</b>

### 1922P2 38"

019220010	0,6 kg
<del>€ 249,00</del>	<b>€ 127,00</b>

Velocità libera	giri/min	700
Coppia massima	Nm	<b>68</b>
Capacità vite/dado	Cl 8.8	M10●16 mm
Capacità vite/dado	Cl 12.9	M8●13 mm
Attacco aria	GAS	1/2"
Pressione di utilizzo	bar	6,2
Ø interno tubo aria	mm	10
Consumo aria medio	l/min	88

## Coppie elevate senza contraccolpi sul polso

**136 Nm**



292 mm

### 1922P3 12"

019220013	1,5 kg
<del>€ 345,00</del>	<b>€ 199,00</b>



Velocità libera	giri/min	600
Coppia massima	Nm	<b>136</b>
Capacità vite/dado	Cl 8.8	M12●18 mm
Capacità vite/dado	Cl 12.9	M10●16 mm
Attacco aria	GAS	1/2"
Pressione di utilizzo	bar	6,2
Ø interno tubo aria	mm	10
Consumo aria medio	l/min	113





## 1933IH

### Smerigliatrice assiale alta potenza

- Fornita con pinza di Ø 3 e 6 mm

**Novità**

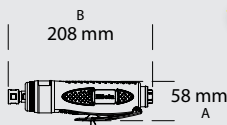

Velocità libera	giri/min	20.000
Capacità pinza	mm	3-6
Potenza	kW	0,75
Attacco aria	GAS	1/4"
Pressione di utilizzo	bar	6,2
Ø interno tubo aria	mm	10
Consumo aria medio	l/min	370

019330006 800 g

€ 175,00 € 99,50

## 1933ILH

### Smerigliatrice assiale alta potenza con albero prolungato

- Fornita con pinza di Ø 3 e 6 mm

**Novità**

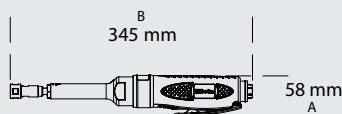

Velocità libera	giri/min	20.000
Capacità pinza	mm	3-6
Potenza	kW	0,75
Attacco aria	GAS	1/4"
Pressione di utilizzo	bar	6,2
Ø interno tubo aria	mm	10
Consumo aria medio	l/min	370

019330011 1,2 kg

€ 330,00 € 189,00

## 1933AN90-H

### Smerigliatrice angolare alta potenza

- Fornita con pinza di Ø 3 e 6 mm

**Novità**

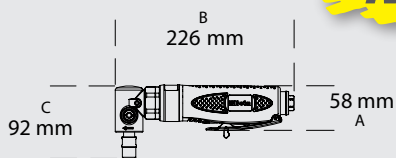

Velocità libera	giri/min	15.000
Capacità pinza	mm	3-6
Potenza	kW	0,75
Attacco aria	GAS	1/4"
Pressione di utilizzo	bar	6,2
Ø interno tubo aria	mm	10
Consumo aria medio	l/min	370

019330021 1,1 kg

€ 330,00 € 189,00

## 1936/5A

### Smerigliatrice angolare

- Estremamente compatta e maneggevole
- Dotata di "air governor" per il controllo automatico del massimo della velocità
- Dotata di maniglia ausiliaria con possibilità dx/sx
- Bloccaggio dell'albero mediante il pulsante "spindle lock"
- Dotata di accessorio per il cambio rapido dei dischi
- La cuffia di protezione può essere regolata velocemente in 9 diverse posizioni mediante sgancio rapido
- Scarico dell'aria posteriore



Ø 125 mm

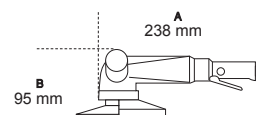

Velocità libera	giri/min	10.000
Dimensione mola	mm	125
Potenza	kW	0,66
Filettatura albero	M	14
Attacco aria	GAS	1/4"
Pressione di utilizzo	bar	6,2
Ø interno tubo aria	mm	10
Consumo aria medio	l/min	390

019360025 1,9 kg

€ 356,00 € 199,50

## 1945C

### Graffettatrice, groppinatrice combinata

- Impugnatura rivestita in gomma
- Corpo leggero in alluminio
- Scarico dell'aria orientabile a 360°
- Sicurezza sul puntale
- Meccanismo di disinceppamento
- Campi di impiego: costruzione telai in legno e casse di imballaggio, applicazione rivestimenti ed isolanti, fissaggio battiscopa e cornici ferma vetro



Capacità caricatore	pz.	100
Attacco aria	GAS	1/4"
Pressione di utilizzo	bar	5-8
Ø interno tubo aria	mm	8
Consumo aria (7 bar)	l/ciclo	1,12

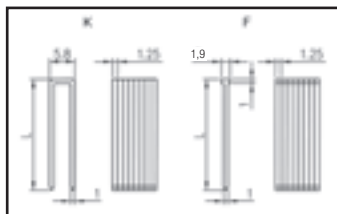

1945C/G

1945C/GP

019450200	1,1 kg
€ 214,00	€ 121,50

## 1945S

### Graffettatrice

- Impugnatura rivestita in gomma
- Corpo leggero in alluminio
- Scarico dell'aria orientabile a 360°
- Sicurezza sul grilletto
- Campi di impiego: settore calzaturiero, produzione e finitura mobili, cornici, costruzione di porte e finestre, allestimenti fieristici, cucitura di sacchetti



Capacità caricatore	pz.	157
Attacco aria	GAS	1/4"
Pressione di utilizzo	bar	4,2-7
Ø interno tubo aria	mm	8
Consumo aria (7 bar)	l/ciclo	0,34

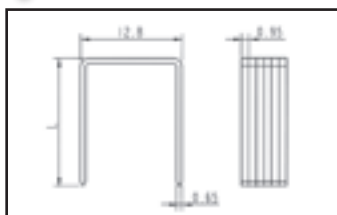

1945S/G

019450000	870 g
€ 163,00	€ 94,00

## 1945P

### Spillatrice

- Impugnatura rivestita in gomma
- Corpo leggero in alluminio
- Sicurezza sul grilletto
- Campi di impiego: fissaggi invisibili, finiture mobili, realizzazione cornici, fissaggio coprifili



Capacità caricatore	pz.	145
Attacco aria	GAS	1/4"
Pressione di utilizzo	bar	4-7
Ø interno tubo aria	mm	8
Consumo aria (7 bar)	l/ciclo	0,27

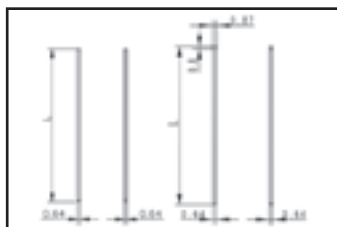

1945P/S

019450100	870 g
€ 260,00	€ 149,00

## 1945C/G... **Novità**

### Graffette

Tipo 90, sezione 1,25x1,0 mm (18 Gauge), larghezza 5,8 mm per 1945C

L mm	€	€	019450216
16	€ 11,40	€ 6,60	019450216
19	€ 13,60	€ 7,85	019450219
22	€ 14,90	€ 8,65	019450222
25	€ 17,50	€ 10,00	019450225
28	€ 18,50	€ 10,70	019450228
32	€ 21,50	€ 12,40	019450232
35	€ 23,20	€ 13,40	019450235
38	€ 25,50	€ 14,80	019450238
40	€ 27,50	€ 15,90	019450240

I prezzi indicati sono relativi a 5.000 pezzi

## 1945C/GP... **Novità**

### Groppini

Tipo B12, sezione 1,25x1,0 mm (18 Gauge), testa da 1,9 mm per 1945C

L mm	€	€	019450255
15	€ 6,00	€ 3,45	019450255
16	€ 6,20	€ 3,60	019450256
20	€ 7,20	€ 4,15	019450260
25	€ 8,50	€ 4,90	019450265
30	€ 9,80	€ 5,50	019450270
32	€ 10,70	€ 6,20	019450272
35	€ 11,60	€ 6,70	019450275
38	€ 12,50	€ 7,20	019450278
40	€ 13,00	€ 7,55	019450280
45	€ 14,30	€ 8,30	019450285
50	€ 15,70	€ 9,10	019450290

I prezzi indicati sono relativi a 5.000 pezzi

## 1945S/G... **Novità**

### Graffette

tipo 80, sezione 0,95x0,65 mm (21 Gauge), larghezza 12,8 mm per 1945S

L mm	€	€	019450004
4	€ 15,00	€ 8,70	019450004
6	€ 5,80	€ 3,35	019450006
8	€ 6,40	€ 3,70	019450008
10	€ 7,20	€ 4,15	019450010
12	€ 8,00	€ 4,60	019450012
14	€ 8,70	€ 5,00	019450014
16	€ 9,50	€ 5,50	019450016

I prezzi indicati sono relativi a 5.000 pezzi

• I prezzi indicati sono relativi a 10.000 pezzi

## 1945P/S... **Novità**

### Spilli

tipo B6, Ø 0,64 mm (23 Gauge) per 1945P

L mm	€	€	019450112
12	€ 7,00	€ 4,05	019450112
15	€ 7,70	€ 4,45	019450115
18	€ 8,40	€ 4,85	019450118
20	€ 9,60	€ 5,55	019450120
21	€ 9,80	€ 5,65	019450121
22	€ 10,00	€ 5,80	019450122
25	€ 10,70	€ 6,20	019450125
30	€ 12,30	€ 7,10	019450130
35	€ 14,10	€ 8,15	019450135

I prezzi indicati sono relativi a 10.000 pezzi



## 1951A

**Novità**

### Pistola di lavaggio con aspirazione

- Indicata per la pulizia di tappezzeria auto, moquette, sedili e bagagliai
- Da utilizzare con detergenti specifici
- Serbatoio da 1L
- Dotato di rubinetto per la regolazione dell'uscita del liquido contenuto nel serbatoio
- **Completa di tubo corrugato da 1,8 m**
- Compatibile con aspiratore codice 1873 - 1874



Capacità serbatoio	litri	1
Attacco aria	GAS	1/4"
Pressione di utilizzo	bar	6,2
Ø interno tubo aria	mm	8
Consumo aria medio	l/min	120

019510101 800 g  
 € 198,00 € 114,00

## 1946C4,8

### Rivettatrice con aspirazione automatica

- Per impiego con rivetti in acciaio, acciaio inox, alluminio e rame, da 2,4 - 3,2 - 4,0 - 4,8 mm
- Becco conico a punta
- Potente e maneggevole, con impugnatura in composito
- Completa di serbatoio portasteli



Materiale/rivetto	2,4	3,2	4	4,8
Rame	✓	✓	✓	✓
Alluminio	✓	✓	✓	✓
Acciaio	✓	✓	✓	✓
Acciaio Inox	✓	✓	✓	✓

Potenza di trazione	N	8.900
Lunghezza della corsa	mm	15
Capacità massima rivetti	Ø acciaio inox	4,8 mm
Attacco aria	GAS	1/4"
Pressione di utilizzo	bar	6,2
Ø interno tubo aria	mm	10
Consumo aria	l/ciclo	2,6

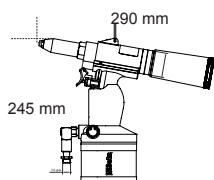

019460006 1,5 kg  
 € 505,00 € 289,00

## 1942A

### Seghetto alternativo

- Potente e maneggevole
- Ideale per tagliare carrozzerie, scarichi e marmitte, alluminio e plastica
- Dotato di impugnatura in gomma, tubo di scarico in PVC e tubo di alimentazione raccordato
- Scarico dell'aria posteriore

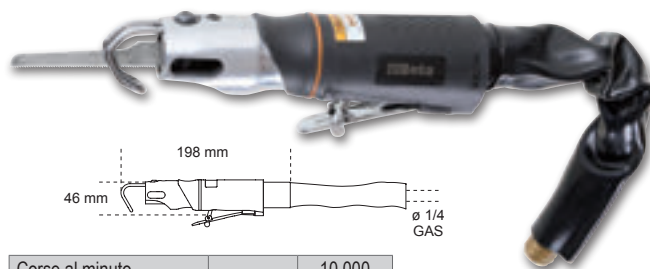

Corse al minuto		10.000
Lunghezza della corsa	mm	10
Attacco aria	GAS	1/4"
Pressione di utilizzo	bar	6,2
Ø interno tubo aria	mm	8
Consumo aria medio	l/min	75



019420000 550 g  
 € 266,00 € 152,50

## Avvolgitubo automatici

- Corpo in materiale plastico antiurto per aria compressa o acqua fredda
- Staffa di fissaggio metallica, orientabile
- Dispositivo automatico di arresto del tubo alla lunghezza desiderata

### 1901BM/8 1901T/10

Attacco aria	GAS	1/4"	3/8"
Lunghezza tubo	m	9+1	15+1
Pressione massima di utilizzo	bar	12	15
Ø interno tubo aria	mm	8	10
Materiale Tubo		Poliuretano	Poliuretano

## 1901BM/8

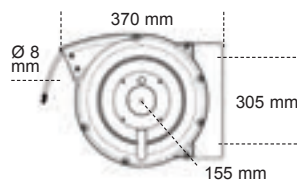

019010111 3,5 kg  
 € 220,00 € 126,50

## 1901T/10

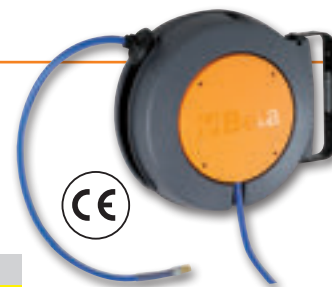
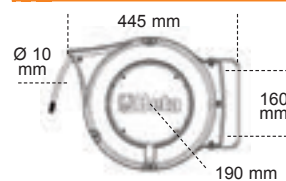

019010210 6,5 kg  
 € 264,00 € 151,50



## 1952

**Novità**

### Aerografo per verniciatura professionale

- Corpo in alluminio pressofuso con trattamento protettivo in nickel chimico nero
- Tazza in nylon con dispositivo salvagoccia, filetto 3/8M BSP
- Filettatura sul corpo 1/4" BSP Gas cilindrica
- Regolatore di pressione e di portata aria
- Regolatore del getto da tondo a ventaglio
- Regolatore della quantità di vernice
- Fornito con chiave di servizio per la manutenzione



Ø ugello				
1952 1,2	019520012	€ 132,00	€ 76,00	
1952 1,5	019520015	€ 132,00	€ 76,00	
1952 1,8	019520018	€ 132,00	€ 76,00	
1952 2,0	019520020	€ 132,00	€ 76,00	

## 1949DGT

### Pistola digitale per gonfiaggio pneumatici

- pressione di esercizio: 0÷11 bar (2.0÷160 psi)
- 4 unità di misura: psi/bar/kgcm2/kpa
- display LCD retroilluminato
- funzione reset
- autospegnimento dopo 3 min.
- pulsante di scarico pressione
- risoluzione: 0,05 bar
- corpo in abs, guscio protettivo in gomma sul manometro, impugnatura antiurto e antiscivolo
- alimentazione: 2 batterie 1,5V tipo AAA
- compatibile con l'innesto 1916I 1/4"



019490020	500 g
€ 139,00	€ 79,00

## 1949U5

**Novità**

### Pistola di soffiaggio progressiva con 5 ugelli

- Corpo in materiale composito ad alta resistenza, antiurto
- 3 ugelli in acciaio 100/160/320 mm con puntale di protezione in gomma antigraffio
- 1 ugello "Turbo" in nylon rinforzato con fibre di vetro con puntale di sicurezza
- 1 ugello orientabile 100 mm in nylon rinforzato con fibre di vetro
- Dotato di sistema di fissaggio rapido



019490030 230 g

€ 31,00 € 17,50



# PANTALONI da lavoro "LIGHT"

## 7840BL

### Pantaloni da lavoro

- T/C Twill, 65% poliestere, 35% cotone, 245 g
- Fascia porta martello
- Triple cuciture nei punti di maggiore usura
- Chiusura metal zip
- Tasca porta metro con inserti porta penne o piccoli utensili

XS	078400100
S	078400101
M	078400102
L	078400103
XL	078400104
XXL	078400105
XXXL	078400106
XXXXL	078400107



~~€ 33,00~~ € 18,90

## 7860E

### Pantaloni leggeri da lavoro

- T/C twill, 65% poliestere, 35% cotone, 180 g
- Fascia porta martello
- Triple cuciture nei punti di maggiore usura
- Chiusura metal zip
- Tasca porta metro con inserti porta penne o piccoli utensili
- Inserti per ginocchiere

XS	078600900
S	078600901
M	078600902
L	078600903
XL	078600904
XXL	078600905
XXXL	078600906
XXXXL	078600907



~~€ 45,00~~ € 25,90

## 7870E

### Pantaloni leggeri da lavoro

- T/C twill, 65% poliestere, 35% cotone, 180 g
- Fascia porta martello
- Triple cuciture nei punti di maggiore usura
- Chiusura metal zip
- Tasca porta metro con inserti porta penne o piccoli utensili
- Inserti per ginocchiere

XS	078700900
S	078700901
M	078700902
L	078700903
XL	078700904
XXL	078700905
XXXL	078700906
XXXXL	078700907



~~€ 45,00~~ € 25,90

## 7830ST

### Pantaloni da lavoro elasticizzati

- T/C Twill 250 g, grigio
- Cavallo antistrappo
- Vita elasticizzata ai lati
- Tasca porta metro e porta martello



XS	078300000
S	078300001
M	078300002
L	078300003
XL	078300004
XXL	078300005
XXXL	078300006

**SLIM FIT**

**STRETCH**



~~€ 51,00~~ € 29,00

# PANTALONI da lavoro "STRONG"

## 7816G

### Pantaloni da lavoro multitasche

- T/C Canvas, 65% poliestere, 35% cotone, 260 g rinforzati in poliestere 600D
- Vita più alta nella parte posteriore per maggiore protezione della schiena
- Anello per portachiavi in vita
- Ampie tasche laterali con chiusura a bottoni automatici, una dotata di inserto portabadge
- Cavallo antistrappo



XS	078160000
S	078160001
M	078160002
L	078160003
XL	078160004
XXL	078160005
XXXL	078160006

~~€ 63,00~~ € 36,00

## 7880SC

### Pantaloni da lavoro elasticizzati Slim fit

- T/C Canvas, 63% poliestere, 34% cotone, 3% tessuto elasticizzato, 290 g
- Cavallo antistrappo
- Tasca porta metro e fascia porta martello
- Inserti porta ginocchiere



XS	078800000
S	078800001
M	078800002
L	078800003
XL	078800004
XXL	078800005
XXXL	078800006

~~€ 52,00~~ € 29,50

## 7900E

### Pantaloni da lavoro multitasche

- In T/C Canvas, 65% poliestere, 35% cotone, 260 g
- Fascia porta martello
- Triple cuciture nei punti di maggiore usura
- Chiusura metal zip
- Tasca porta metro con inserti porta penne o piccoli utensili



XS	079000900
S	079000901
M	079000902
L	079000903
XL	079000904
XXL	079000905
XXXL	079000906
XXXXL	079000907

~~€ 48,50~~ € 27,50

## 7525

### Jeans da lavoro elasticizzati

- 68% Cotone denim, 29% poliestere, 3% tessuto elasticizzato, 100Z
- Rinforzi in poliestere 600D all'interno delle tasche posteriori e sul fondo gamba
- Tasca porta metro e fascia porta martello
- Cavallo antistrappo



XS	075250046
S	075250048
M	075250050
L	075250052
XL	075250054
XXL	075250056
XXXL	075250058

~~€ 53,00~~ € 29,90

**YKK**  
Little Parts. Big Difference.





# ABBIGLIAMENTO da lavoro "CASUAL"

**7810**

**Novità**

**Pantaloni multitasche "work trekking"**

- 90% nylon, 10% tessuto elasticizzato, 265 g, antracite
- Vita elasticizzata
- Tessuto bi-estensibile per aumentare il comfort
- Fondo gamba elasticizzato con chiusura zip verticale

S	078100101
M	078100102
L	078100103
XL	078100104
XXL	078100105

**Heavy**



~~€ 70,00~~ € 39,90

**7811**

**Pantaloni "work trekking"**

- 90% nylon, 10% tessuto elasticizzato, 230 g, grigio
- Vita elasticizzata
- Tessuto bi-estensibile per aumentare il comfort
- Fondo gamba elasticizzato con chiusura zip verticale

S	078110001
M	078110002
L	078110003
XL	078110004
XXL	078110005

**Peso medio**

**SLIM FIT**



~~€ 66,50~~ € 37,90

**7812**

**Novità**

**Pantaloni "work trekking"**

- 95% nylon, 5% tessuto elasticizzato, 140 g, grigio
- slim fit, vestibilità ergonomica per favorire i movimenti e tessuto bi-estensibile per aumentare il comfort inserti rinforzati su ginocchia, cavallo e fondo gamba

S	078120001
M	078120002
L	078120003
XL	078120004
XXL	078120005

**Light**



~~€ 64,00~~ € 36,50

**7634G**

**Novità**

**Felpa tecnica zip lunga**

- felpa tecnica zip lunga, 325 g, 67% poliestere, 28% rayon, 5% spandex
- Tessuto 3D che imprigiona l'aria garantendo elevata traspirabilità e libertà di movimento

XS	076340100
S	076340101
M	076340102
L	076340103
XL	076340104
XXL	076340105
XXXL	076340106



~~€ 69,00~~ € 39,90

**7780T**

**Bomber da lavoro multitasche**

- Tessuto principale: 100% nylon 300D, impermeabilizzato e resistente
- Inserti per favorire i movimenti: 95% poliestere 5% tessuto elasticizzato, impermeabilizzato
- Imbottitura in poliestere 160 g
- Cappuccio staccabile

S	077800101
M	077800102
L	077800103
XL	077800104
XXL	077800105
XXXL	077800106



~~€ 90,00~~ € 51,00

**7683**

**Giacca softshell con cappuccio e maniche staccabili**

- 94% poliestere, 6% spandex, 290 g con cappuccio e maniche staccabili, Tessuto idrorepellente a tre strati, dotato di membrana TPU impermeabile, antivento e traspirante

S	076830001
M	076830002
L	076830003
XL	076830004
XXL	076830005
XXXL	076830006



~~€ 119,50~~ € 69,00

# NUOVA LINEA 100% COTONE ELASTICIZZATO

## 7930G

### Pantaloni da lavoro

- 100% cotone elasticizzato, 220 g
- Slim Fit

**Novità**



XS	079300300
S	079300301
M	079300302
L	079300303
XL	079300304
XXL	079300305
XXXL	079300306

~~€ 51,00~~ € 29,50

## 7933G

### Salopette da lavoro

- 100% cotone elasticizzato, 220 g
- Slim Fit

**Novità**



XS	079330300
S	079330301
M	079330302
L	079330303
XL	079330304
XXL	079330305
XXXL	079330306

~~€ 64,00~~ € 36,90

## 7935G

### Tuta da lavoro

- 100% cotone elasticizzato, 220 g
- Slim Fit

**Novità**



XS	079350300
S	079350301
M	079350302
L	079350303
XL	079350304
XXL	079350305
XXXL	079350306

~~€ 86,00~~ € 49,50

## 7939G

### Giacca da lavoro

- 100% cotone elasticizzato, 220 g
- Slim Fit

**Novità**



XS	079390300
S	079390301
M	079390302
L	079390303
XL	079390304
XXL	079390305
XXXL	079390306

~~€ 55,00~~ € 31,90

## 7931G

### Bermuda da lavoro

- 100% cotone elasticizzato, 220 g
- Slim Fit

**Novità**



XS	079310300
S	079310301
M	079310302
L	079310303
XL	079310304
XXL	079310305
XXXL	079310306

~~€ 39,50~~ € 22,90



# TUTE e GIACCHE da lavoro

## 7865E

Tuta leggera da lavoro

- T/C twill, 65% poliestere, 35% cotone, 180 g

XS	078650900
S	078650901
M	078650902
L	078650903
XL	078650904
XXL	078650905
XXXL	078650906



~~€ 70,50~~ € 40,30

## 7863E

Salopette leggera da lavoro

- T/C twill, 65% poliestere, 35% cotone, 180 g

XS	078630900
S	078630901
M	078630902
L	078630903
XL	078630904
XXL	078630905
XXXL	078630906
XXXXL	078630907



~~€ 54,50~~ € 31,20

## 7905E

Tuta da lavoro

- In T/C Canvas, 65% poliestere, 35% cotone, 260 g

XS	079050900
S	079050901
M	079050902
L	079050903
XL	079050904
XXL	079050905
XXXL	079050906
XXXXL	079050907



~~€ 76,00~~ € 43,50

## 7903E

Salopette da lavoro

- In T/C Canvas, 65% poliestere, 35% cotone, 260 g

XS	079030900
S	079030901
M	079030902
L	079030903
XL	079030904
XXL	079030905
XXXL	079030906
XXXXL	079030907



~~€ 60,50~~ € 34,50

## 7869E

Giacca leggera da lavoro

- T/C twill, 65% poliestere, 35% cotone, 180 g

XS	078690900
S	078690901
M	078690902
L	078690903
XL	078690904
XXL	078690905
XXXL	078690906
XXXXL	078690907



~~€ 48,50~~ € 27,50

## 7867E

Gilet multitasche leggero da lavoro

- T/C twill, 65% poliestere, 35% cotone, 180 g

XS	078670900
S	078670901
M	078670902
L	078670903
XL	078670904
XXL	078670905
XXXL	078670906
XXXXL	078670907



~~€ 41,50~~ € 23,50



# LINEA "BASIC"

Prodotte con lamina antiperforazione in fibra composita: **MAGGIORE FLESSIBILITÀ= MAGGIOR COMFORT**

## 7241CK

Scarpe in pelle idrorepellente

- Puntale in acciaio
- Lamina antiperforazione in fibra composita

EU	UK	Articolo
35	2,5	072411535
36	3,5	072411536
37	4,5	072411537
38	5	072411538
39	6	072411539
40	6,5	072411540
41	7	072411541
42	8	072411542
43	9	072411543
44	10	072411544
45	10,5	072411545
46	11	072411546
47	12	072411547
48	13	072411548



EN ISO 20345 2011

S3 SRC

€ 40,00 € 22,80

## 7243CK

Scarpe alte in pelle idrorepellente con rapido sfilamento

- Puntale in acciaio
- Lamina antiperforazione in fibra composita

EU	UK	Articolo
35	2,5	072431335
36	3,5	072431336
37	4,5	072431337
38	5	072431338
39	6	072431339
40	6,5	072431340
41	7	072431341
42	8	072431342
43	9	072431343
44	10	072431344
45	10,5	072431345
46	11	072431346
47	12	072431347
48	13	072431348



RAPIDO SFILAMENTO

EN ISO 20345 2011

S3 RS SRC

€ 41,00 € 23,50

## 7245BK

Scarpe alte "saldatore" stringate in pelle idrorepellente con rapido sfilamento e protezione frontale con chiusura a strappo

- Puntale in acciaio
- Lamina antiperforazione in fibra composita

EU	UK	Articolo
35	2,5	072451235
36	3,5	072451236
37	4,5	072451237
38	5	072451238
39	6	072451239
40	6,5	072451240
41	7	072451241
42	8	072451242
43	9	072451243
44	10	072451244
45	10,5	072451245
46	11	072451246
47	12	072451247
48	13	072451248



RAPIDO SFILAMENTO

EN ISO 20345 2011

S3 RS SRC

€ 47,50 € 27,00

## 7246BK

Scarpe in pelle scamosciata traforata

- Puntale in acciaio
- Lamina antiperforazione in fibra composita

EU	UK	Articolo
35	2,5	072461235
36	3,5	072461236
37	4,5	072461237
38	5	072461238
39	6	072461239
40	6,5	072461240
41	7	072461241
42	8	072461242
43	9	072461243
44	10	072461244
45	10,5	072461245
46	11	072461246
47	12	072461247
48	13	072461248



EN ISO 20345 2011

S1P SRC

€ 41,00 € 23,30



# LINEA "EASY PLUS"



## 7220PEK

Scarpe in pelle idrorepellente con inserti in nylon e rinforzo antiabrasione nella zona del puntale

- Puntale in composito
- Lamina antiperforazione in fibra composita

EU	UK	Articolo
35	2,5	072200235
36	3,5	072200236
37	4,5	072200237
38	5	072200238
39	6	072200239
40	6,5	072200240
41	7	072200241
42	8	072200242
43	9	072200243
44	10	072200244
45	10,5	072200245
46	11	072200246
47	12	072200247
48	13	072200248



€54,00 € 31,00

EN ISO 20345 2011

S3 SRC

## 7221PEK

Scarpe alte in pelle idrorepellente con inserti in nylon, rinforzo antiabrasione nella zona del puntale e rapido sfilamento

- Puntale in composito
- Lamina antiperforazione in fibra composita

EU	UK	Articolo
35	2,5	072210235
36	3,5	072210236
37	4,5	072210237
38	5	072210238
39	6	072210239
40	6,5	072210240
41	7	072210241
42	8	072210242
43	9	072210243
44	10	072210244
45	10,5	072210245
46	11	072210246
47	12	072210247
48	13	072210248



RAPIDO SFILAMENTO

€56,00 € 32,00

EN ISO 20345 2011

S3 RS SRC

## 7223PEK

Scarpe in pelle scamosciata con inserti in mesh ad alta traspirazione e rinforzo antiabrasione nella zona del puntale

- Puntale in composito
- Lamina antiperforazione in fibra composita

EU	UK	Articolo
35	2,5	072230135
36	3,5	072230136
37	4,5	072230137
38	5	072230138
39	6	072230139
40	6,5	072230140
41	7	072230141
42	8	072230142
43	9	072230143
44	10	072230144
45	10,5	072230145
46	11	072230146
47	12	072230147
48	13	072230148



€55,00 € 31,50

EN ISO 20345 2011

S1P SRC

## 7224PEK

Scarpe in pelle scamosciata traforata con rinforzo antiabrasione nella zona del puntale

- Puntale in composito
- Lamina antiperforazione in fibra composita

EU	UK	Articolo
35	2,5	072240235
36	3,5	072240236
37	4,5	072240237
38	5	072240238
39	6	072240239
40	6,5	072240240
41	7	072240241
42	8	072240242
43	9	072240243
44	10	072240244
45	10,5	072240245
46	11	072240246
47	12	072240247
48	13	072240248



€55,00 € 31,50

EN ISO 20345 2011

S1P SRC

# LINEA "TREKKING"

Da oggi prodotte con lamina antiperforazione in fibra composita: **MAGGIORE FLESSIBILITÀ= MAGGIOR COMFORT**

## 7235BK

**Novità**

Scarpe basse in action nabuk idrorepellente con copripuntale di rinforzo in poliuretano

- Puntale in acciaio
- Lamina antiperforazione in fibra composita

EU	UK	Articolo
35	2,5	072350335
36	3,5	072350336
37	4,5	072350337
38	5	072350338
39	6	072350339
40	6,5	072350340
41	7	072350341
42	8	072350342
43	9	072350343
44	10	072350344
45	10,5	072350345
46	11	072350346
47	12	072350347
48	13	072350348



~~€ 59,00~~ € 33,90

EN ISO 20345 2011

S3 SRC

## 7236BK

**Novità**

Scarpe alte in action nabuk idrorepellente con copripuntale di rinforzo in poliuretano

- Puntale in acciaio
- Lamina antiperforazione in fibra composita

EU	UK	Articolo
35	2,5	072360335
36	3,5	072360336
37	4,5	072360337
38	5	072360338
39	6	072360339
40	6,5	072360340
41	7	072360341
42	8	072360342
43	9	072360343
44	10	072360344
45	10,5	072360345
46	11	072360346
47	12	072360347
48	13	072360348



~~€ 62,00~~ € 35,90

EN ISO 20345 2011

S3 RS SRC

**RAPIDO SFILAMENTO**

## 7248GK

**Novità**

Scarpe basse in pelle scamosciata con inserti in nylon e copripuntale di rinforzo in poliuretano

- Puntale in acciaio
- Lamina antiperforazione in fibra composita

EU	UK	Articolo
35	2,5	072480235
36	3,5	072480236
37	4,5	072480237
38	5	072480238
39	6	072480239
40	6,5	072480240
41	7	072480241
42	8	072480242
43	9	072480243
44	10	072480244
45	10,5	072480245
46	11	072480246
47	12	072480247
48	13	072480248



~~€ 48,00~~ € 27,80

EN ISO 20345 2011

S1P SRC

## 7249GK

**Novità**

Scarpe alte in pelle scamosciata con inserti in nylon e copripuntale di rinforzo in poliuretano

- Puntale in acciaio
- Lamina antiperforazione in fibra composita

EU	UK	Articolo
35	2,5	072490235
36	3,5	072490236
37	4,5	072490237
38	5	072490238
39	6	072490239
40	6,5	072490240
41	7	072490241
42	8	072490242
43	9	072490243
44	10	072490244
45	10,5	072490245
46	11	072490246
47	12	072490247
48	13	072490248



~~€ 51,00~~ € 29,50

EN ISO 20345 2011

S1P SRC

**RAPIDO SFILAMENTO**







# LINEA "FLEX"

Estremamente flessibili e leggere (peso indicativo misura 42:  $\hat{m}$  490 g)

## 7212FG

Scarpe in pelle scamosciata traforata con inserto antiabrasione nella zona del puntale

- Puntale in composito
- Lamina antiperforazione in fibra composita
- Suola in poliuretano monodensità

EU	UK	US
35	2,5	072120035
36	3,5	072120036
37	4,5	072120037
38	5	072120038
39	6	072120039
40	6,5	072120040
41	7	072120041
42	8	072120042
43	9	072120043
44	10	072120044
45	10,5	072120045
46	11	072120046
47	12	072120047
48	13	072120048



~~€ 59,50~~ € 34,50

EN ISO 20345 2011

S1P SRC

## 7213FG

Scarpe in pelle scamosciata con inserti in mesh ad alta traspirazione

- Puntale in composito
- Lamina antiperforazione in fibra composita
- Suola in poliuretano monodensità

EU	UK	US
35	2,5	072130035
36	3,5	072130036
37	4,5	072130037
38	5	072130038
39	6	072130039
40	6,5	072130040
41	7	072130041
42	8	072130042
43	9	072130043
44	10	072130044
45	10,5	072130045
46	11	072130046
47	12	072130047
48	13	072130048



~~€ 59,50~~ € 34,50

EN ISO 20345 2011

S1P SRC

## 7214FN

Scarpe in action nabuk idrorepellente con inserto antiabrasione nella zona del puntale

- Puntale in composito
- Lamina antiperforazione in fibra composita
- Suola in poliuretano monodensità

EU	UK	US
35	2,5	072140035
36	3,5	072140036
37	4,5	072140037
38	5	072140038
39	6	072140039
40	6,5	072140040
41	7	072140041
42	8	072140042
43	9	072140043
44	10	072140044
45	10,5	072140045
46	11	072140046
47	12	072140047
48	13	072140048



~~€ 64,50~~ € 37,00

EN ISO 20345 2011

S3 SRC

## 7218FN

Scarpe in action nabuk idrorepellente con inserto antiabrasione nella zona del puntale

- Puntale in composito
- Lamina antiperforazione in fibra composita
- Suola in poliuretano monodensità

EU	UK	US
35	2,5	072180035
36	3,5	072180036
37	4,5	072180037
38	5	072180038
39	6	072180039
40	6,5	072180040
41	7	072180041
42	8	072180042
43	9	072180043
44	10	072180044
45	10,5	072180045
46	11	072180046
47	12	072180047
48	13	072180048



RAPIDO SFILAMENTO

~~€ 67,50~~ € 38,80

EN ISO 20345 2011

S3 RS SRC

# LINEA "FLEX EVOLUTION"



## 7212LG

**Novità**

Scarpe basse da donna in pelle scamosciata traforata con inserti in mesh

- Puntale in composito
- Lamina antiperforazione in fibra composita

EU	UK	Articolo
34	2	072120134
35	2,5	072120135
36	3,5	072120136
37	4,5	072120137
38	5	072120138
39	6	072120139
40	6,5	072120140
41	7	072120141
42	8	072120142

**Flex Lady**



~~€ 56,00~~ € 32,50

EN ISO 20345 2011

S1P SRC

## 7217FB

**Novità**

Scarpe in mesh ad alta traspirazione con inserto antiabrasione nella zona del puntale

- Puntale in composito
- Lamina antiperforazione in fibra composita

EU	UK	Articolo
35	2,5	072170135
36	3,5	072170136
37	4,5	072170137
38	5	072170138
39	6	072170139
40	6,5	072170140
41	7	072170141
42	8	072170142
43	9	072170143
44	10	072170144
45	10,5	072170145
46	11	072170146
47	12	072170147
48	13	072170148



~~€ 67,00~~ € 38,50

EN ISO 20345 2011

S1P SRC

## 7217FG

**Novità**

Scarpe in mesh ad alta traspirazione con inserto antiabrasione nella zona del puntale

- Puntale in composito
- Lamina antiperforazione in fibra composita

EU	UK	Articolo
35	2,5	072170235
36	3,5	072170236
37	4,5	072170237
38	5	072170238
39	6	072170239
40	6,5	072170240
41	7	072170241
42	8	072170242
43	9	072170243
44	10	072170244
45	10,5	072170245
46	11	072170246
47	12	072170247
48	13	072170248



~~€ 67,00~~ € 38,50

EN ISO 20345 2011

S1P SRC

## 7219FY

**Novità**

Scarpe in microfibra idrorepellente con inserto antiabrasione nella zona del puntale

- Puntale in composito
- Lamina antiperforazione in fibra composita

EU	UK	Articolo
35	2,5	072190035
36	3,5	072190036
37	4,5	072190037
38	5	072190038
39	6	072190039
40	6,5	072190040
41	7	072190041
42	8	072190042
43	9	072190043
44	10	072190044
45	10,5	072190045
46	11	072190046
47	12	072190047
48	13	072190048



~~€ 70,00~~ € 39,80

EN ISO 20345 2011

S1P SRC

# LINEA "ACTIVE"



## 7314AF

Scarpe in pelle scamosciata con inserti in nylon mesh e carbon

- Puntale in composito
- Lamina antiperforazione in fibra composita

EU	UK	鞋
35	2,5	073140235
36	3,5	073140236
37	4,5	073140237
38	5	073140238
39	6	073140239
40	6,5	073140240
41	7	073140241
42	8	073140242
43	9	073140243
44	10	073140244
45	10,5	073140245
46	11	073140246
47	12	073140247
48	13	073140248



€82,00 € 47,00

EN ISO 20345 2011

S1P SRC

## 7314AB

Scarpe in pelle scamosciata con inserti in nylon mesh e carbon

- Puntale in composito
- Lamina antiperforazione in fibra composita

EU	UK	鞋
35	2,5	073140335
36	3,5	073140336
37	4,5	073140337
38	5	073140338
39	6	073140339
40	6,5	073140340
41	7	073140341
42	8	073140342
43	9	073140343
44	10	073140344
45	10,5	073140345
46	11	073140346
47	12	073140347
48	13	073140348



€82,00 € 47,00

EN ISO 20345 2011

S1P SRC

## 7315AN

Scarpe in pelle scamosciata e microfibrà idrorepellenti con inserti in carbon

- Puntale in composito
- Lamina antiperforazione in fibra composita

EU	UK	鞋
35	2,5	073150535
36	3,5	073150536
37	4,5	073150537
38	5	073150538
39	6	073150539
40	6,5	073150540
41	7	073150541
42	8	073150542
43	9	073150543
44	10	073150544
45	10,5	073150545
46	11	073150546
47	12	073150547
48	13	073150548



€95,00 € 54,00

EN ISO 20345 2011

S3 SRC

## 7318AN

Scarpe alte in pelle scamosciata e microfibrà idrorepellenti con inserti in carbon

- Puntale in composito
- Lamina antiperforazione in fibra composita

EU	UK	鞋
35	2,5	073180535
36	3,5	073180536
37	4,5	073180537
38	5	073180538
39	6	073180539
40	6,5	073180540
41	7	073180541
42	8	073180542
43	9	073180543
44	10	073180544
45	10,5	073180545
46	11	073180546
47	12	073180547
48	13	073180548



€98,00 € 56,00

EN ISO 20345 2011

S3 SRC



## 7294HN

**Novità**

Scarpe alte in pelle nabuk idrorepellente con SUPPORT SYSTEM per il contenimento laterale della caviglia e rapido sfilamento

- Puntale in acciaio
- Lamina antiperforazione in fibra composita

EU	UK	
39	6	072940839
40	6,5	072940840
41	7	072940841
42	8	072940842
43	9	072940843
44	10	072940844
45	10,5	072940845
46	11	072940846
47	12	072940847



**RAPIDO SFILAMENTO**



€ 121,00 € 68,90

**EN ISO 20345 2011**

**S3 HRO HI RS SRC**

## 7340B

Scarpe in tessuto mesh ad alta traspirazione con inserti in PU Alta Frequenza e rinforzo protettivo del puntale in crosta scamosciata

- Puntale in alluminio
- Lamina antiperforazione in fibra composita
- Sistema di chiusura FixLock, semplifica la calzatura e lo sfilamento della scarpa (in dotazione anche stringhe tradizionali)

EU	UK	
36	3,5	073400236
37	4,5	073400237
38	5	073400238
39	6	073400239
40	6,5	073400240
41	7	073400241
42	8	073400242
43	9	073400243
44	10	073400244
45	10,5	073400245
46	11	073400246
47	12	073400247



**FIT PRO NET**



€ 133,00 € 75,50

**EN ISO 20345 2011**

**S1P SRC**

## 7341N

Scarpe in micro pelle scamosciata idrorepellente con inserti in PU Alta Frequenza e rinforzo protettivo del puntale in crosta scamosciata

- Puntale in alluminio
- Lamina antiperforazione in fibra composita
- Sistema di chiusura FixLock, semplifica la calzatura e lo sfilamento della scarpa (in dotazione anche stringhe tradizionali)

EU	UK	
36	3,5	073410236
37	4,5	073410237
38	5	073410238
39	6	073410239
40	6,5	073410240
41	7	073410241
42	8	073410242
43	9	073410243
44	10	073410244
45	10,5	073410245
46	11	073410246
47	12	073410247



**FIT PRO**



€ 140,00 € 78,50

**EN ISO 20345 2011**

**S3 SRC**

## 7398U

Sottopiedi anatomici

TPR GEL con elevato effetto ammortizzante, supporto dell'arco plantare e cuscinetto nella zona del tallone

EU	
36-40	073980058
41-46	073980063



€ 11,00 € 6,50



## 7352A

Scarpe in tessuto mesh ad alta traspirazione con inserti in TPU

- Puntale in composito
- Lamina antiperforazione in fibra composita

EU	UK	
38	5	073520038
39	6	073520039
40	6,5	073520040
41	7	073520041
42	8	073520042
43	9	073520043
44	10	073520044
45	10,5	073520045
46	11	073520046
47	12	073520047
48	13	073520048



€103,00 € 59,50

EN ISO  
20345  
2011

S1P HRO SRC

## 7352B

Scarpe in tessuto mesh ad alta traspirazione con inserti in TPU

- Puntale in composito
- Lamina antiperforazione in fibra composita

EU	UK	
38	5	073520138
39	6	073520139
40	6,5	073520140
41	7	073520141
42	8	073520142
43	9	073520143
44	10	073520144
45	10,5	073520145
46	11	073520146
47	12	073520147
48	13	073520148



€103,00 € 59,50

EN ISO  
20345  
2011

S1P HRO SRC

## 7354N

Scarpe in tessuto mesh idrorepellente con inserti in TPU

- Puntale in composito
- Lamina antiperforazione in fibra composita

EU	UK	
38	5	073540038
39	6	073540039
40	6,5	073540040
41	7	073540041
42	8	073540042
43	9	073540043
44	10	073540044
45	10,5	073540045
46	11	073540046
47	12	073540047
48	13	073540048



€108,00 € 62,50

EN ISO  
20345  
2011

S3 HRO SRC

## 7355V

Scarpe alte in tessuto mesh idrorepellente con inserti in TPU

- Puntale in composito
- Lamina antiperforazione in fibra composita

EU	UK	
38	5	073550038
39	6	073550039
40	6,5	073550040
41	7	073550041
42	8	073550042
43	9	073550043
44	10	073550044
45	10,5	073550045
46	11	073550046
47	12	073550047
48	13	073550048



€115,00 € 66,50

EN ISO  
20345  
2011

S3 HRO SRC



**Novità**

**Quanti passi fai in un giorno?  
E in un anno?**

# LINEA "0-Gravity"

100 grammi in meno<sup>1</sup> per ogni passo percorso corrispondono a un risparmio di circa **1000 chili al giorno** e a più di **200 tonnellate all'anno!**

<sup>1</sup>rispetto al peso medio di una scarpa di pari categoria misura 42

- Suola in EVA con battistrada in gomma nitrilica ad alta resistenza
- Collare "slip on" elasticizzato per facilitare la calzata
- Supporto di stabilità tallone

**CAMMINA  
PIÙ LEGGERO!**

**420 g**

(peso indicativo misura 42)

EU	UK	
38	5	073530038
39	6	073530039
40	6,5	073530040
41	7	073530041
42	8	073530042
43	9	073530043
44	10	073530044
45	10,5	073530045
46	11	073530046
47	12	073530047
48	13	073530048



**7353Y**

Scarpe in tessuto mesh ad alta traspirazione con inserti in TPU  
Tomaia dotata di speciali maglie riflettenti ad alta visibilità

- Puntale in fibra di carbonio
- Lamina antiperforazione in fibra composita

€ 134,00 € 77,00



EN ISO  
20345  
2011

S1P HRO SRC





Le immagini sono indicative, Beta Utensili si riserva il diritto di apportare aggiornamenti e migliorie alla propria gamma produttiva senza alcun preavviso.



**umc** S.p.A.  
**UTENSILERIA MECCANICA CASSANESE**  
www.umc.it info@umc.it Tel. 0331-201057



Beta Utensili S.p.A. | via Volta, 18 | 20845 Sovico (MB) | tel +39 039 20771  
[www.beta-tools.com](http://www.beta-tools.com)