

PORTASTAMPI

pag	115	RIVESTIMENTI PVD
		DENOMINAZIONE DELLE PIASTRE
pag	116	SERIE 156
pag	117	SERIE 156
pag	118	SERIE 196
pag	119	SERIE 196
pag	120	SERIE 246
pag	121	SERIE 246
pag	122	SERIE 296
pag	123	SERIE 296
pag	124	SERIE 346
pag	125	SERIE 346
pag	126	SERIE 396
pag	127	SERIE 396
pag	128	SERIE 446
pag	129	SERIE 446
pag	130	SERIE 496
pag	131	SERIE 496
pag	132	SERIE 546
pag	133	SERIE 546
pag	134	SERIE 596
pag	135	SERIE 596

DENOMINAZIONE DELLE PIASTRE

n Portastampi a partire dalla serie 156 fino alla serie 496 con piastre completamente intercambiabili.

n Internamente costruiamo portastampi a disegno.

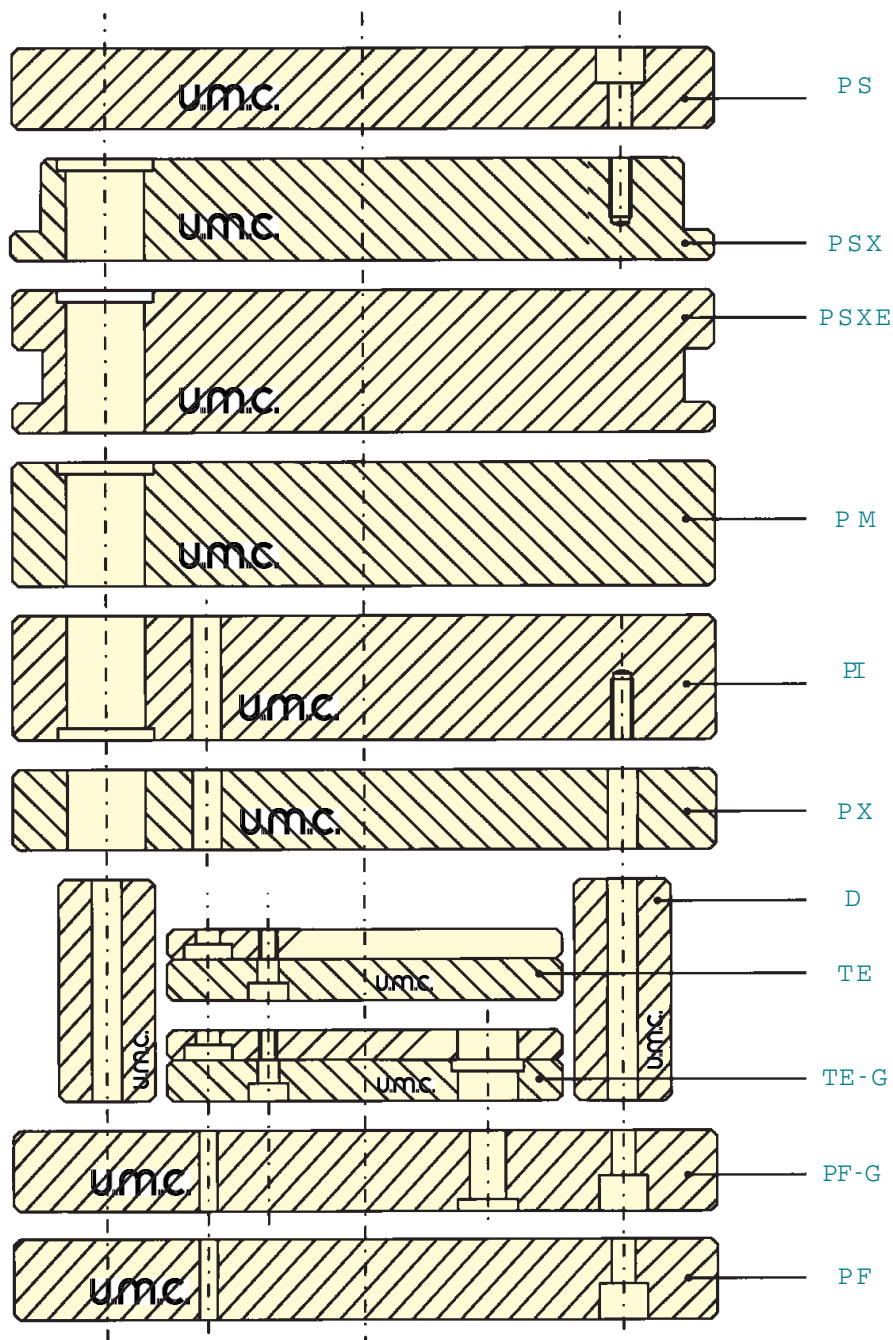

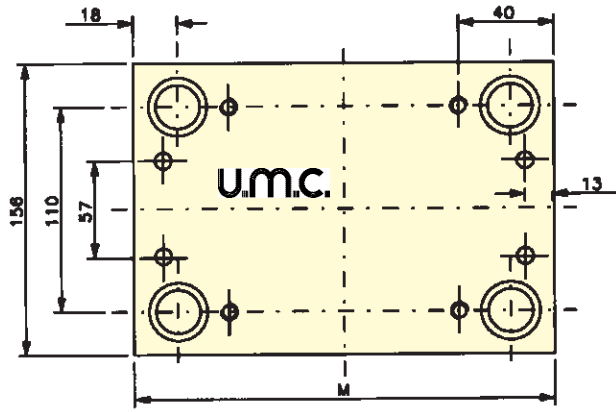

PS

L x M	S				N Fori Viti
156 x 156	22				4
156 x 196	22				4
156 x 246	22				4

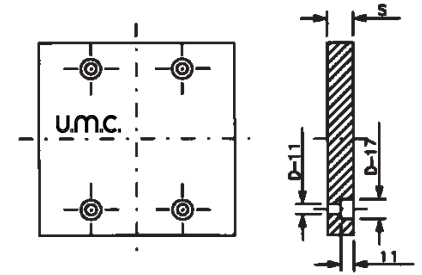

PSX

L x M	S				N Fori Viti
156 x 156	22	26	36	46	4
156 x 196	22	26	36	46	4
156 x 246	22	26	36	46	4

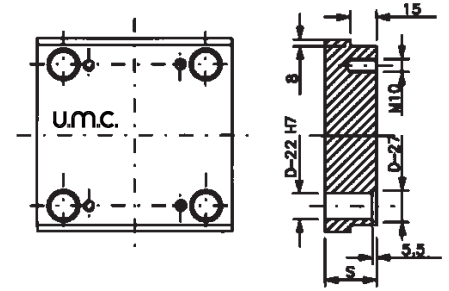

PSXE

L x M	S							
156 x 156	46	56	66	76				
156 x 196	46	56	66	76				
156 x 246	46	56	66	76				

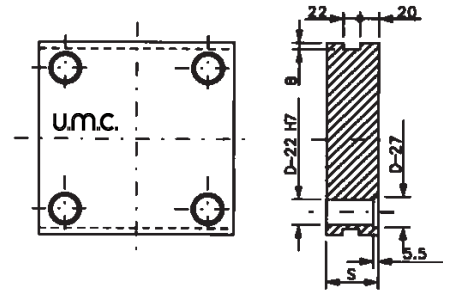

PI

L x M	S								N Viti
156 x 156	22	26	36	46	56	66	76		4
156 x 196	22	26	36	46	56	66	76		4
156 x 246	22	26	36	46	56	66	76		4

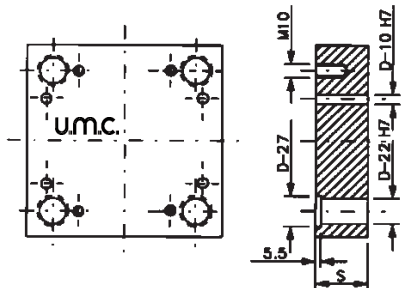

P M

L x M	S							
156 x 156	22	26	36	46	56	66	76	
156 x 196	22	26	36	46	56	66	76	
156 x 246	22	26	36	46	56	66	76	

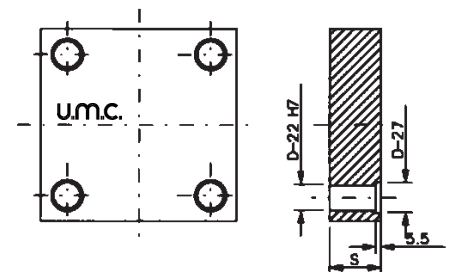

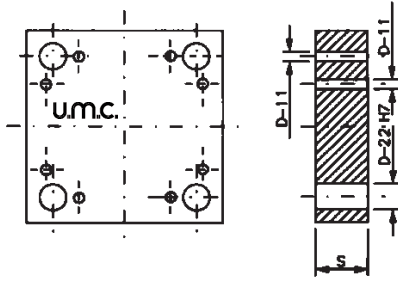

PX

L x M	S		N Fori Viti
156 x 156	22		4
156 x 196	22		4
156 x 246	22		4

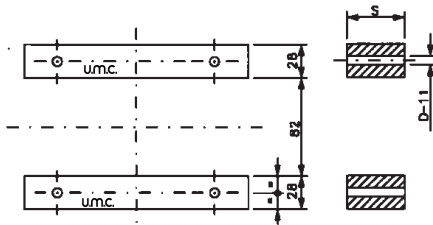

D

L x M	S		N Fori Viti
156 x 156	57	77	4
156 x 196	57	77	4
156 x 246	57	77	4

TE

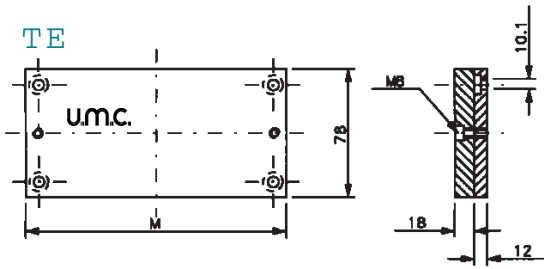

TEG

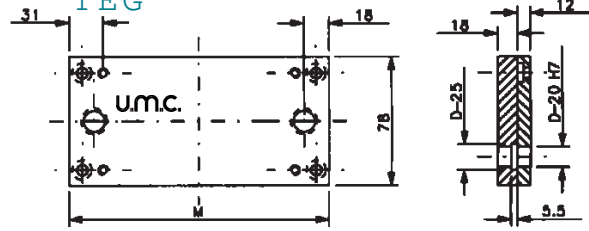

PF - PFG

L x M	N sedi viti
156 x 156	4
156 x 196	4
156 x 246	4

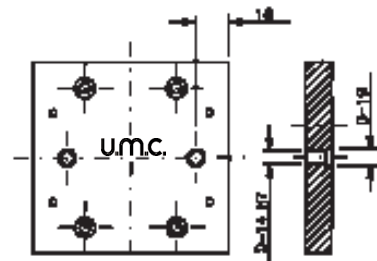
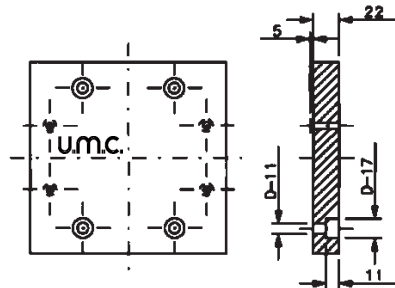

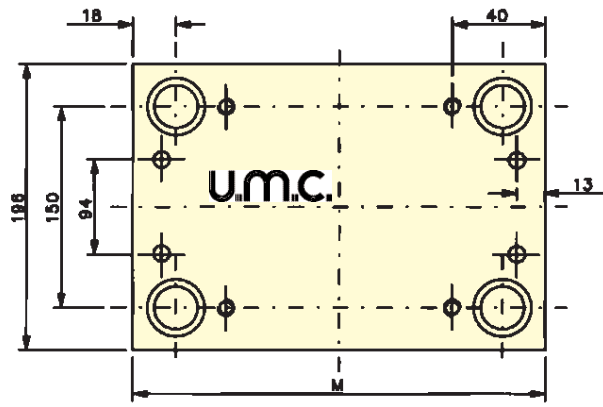

PS

L x M	S				N Fori Viti
196 x 196	22				4
196 x 246	22				4
196 x 296	22				4
196 x 346	22				4

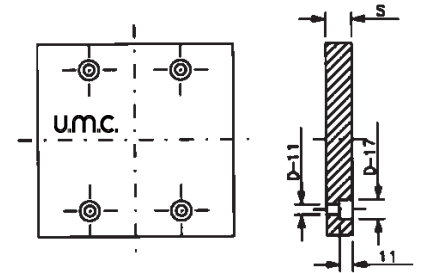

PSX

L x M	S				N Fori Viti
196 x 196	26	36	46	56	4
196 x 246	26	36	46	56	4
196 x 296	26	36	46	56	4
196 x 346	26	36	46	56	4

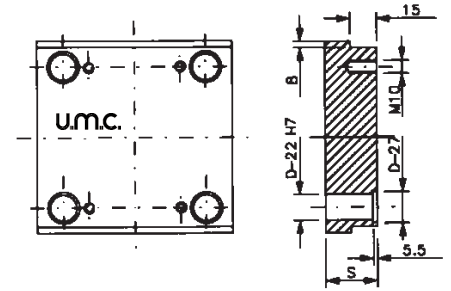

PSXE

L x M	S				N Fori Viti				
196 x 196	46	56	66	76	96				
196 x 246	46	56	66	76	96				
196 x 296	46	56	66	76	96				
196 x 346	46	56	66	76	96				

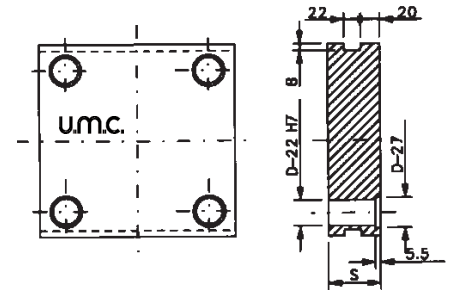

PI

L x M	S				N Fori Viti			
196 x 196	26	36	46	56	66	76	96	4
196 x 246	26	36	46	56	66	76	96	4
196 x 296	26	36	46	56	66	76	96	4
196 x 346	26	36	46	56	66	76	96	4

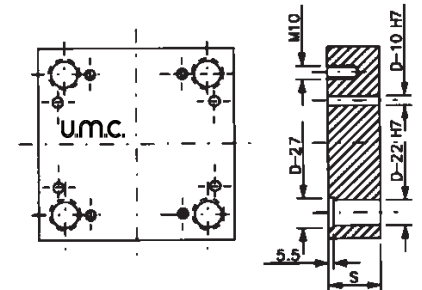

PM

L x M	S				N Fori Viti				
196 x 196	22	26	36	46	56	66	76	96	4
196 x 246	22	26	36	46	56	66	76	96	4
196 x 296	22	26	36	46	56	66	76	96	4
196 x 346	22	26	36	46	56	66	76	96	4

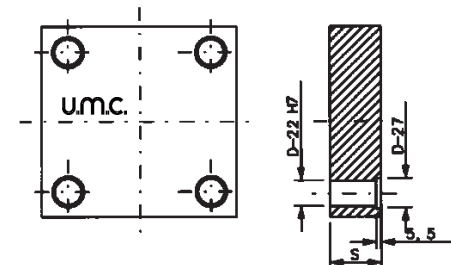

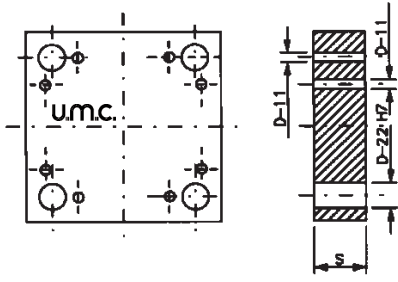

PX

L x M	S			N Fori Viti
196 x 196	26			4
196 x 246	26			4
196 x 296	26			4
196 x 346	26			4

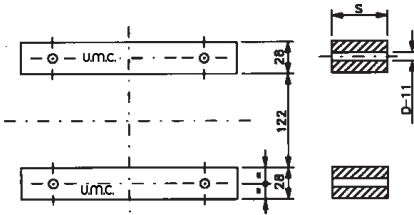

D

L x M	S			N Fori Viti
196 x 196	57	77	97	4
196 x 246	57	77	97	4
196 x 296	57	77	97	4
196 x 346	57	77	97	4

TE

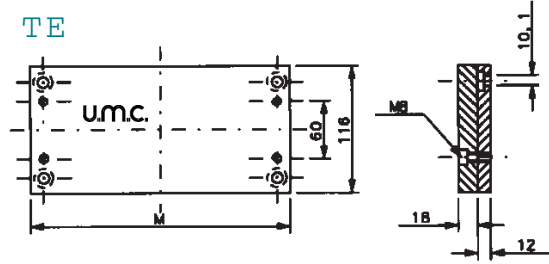

TEG

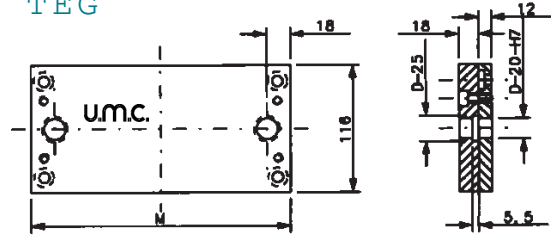

PF - PFG

L x M	N sedi viti
196 x 196	4
196 x 246	4
196 x 296	4
196 x 346	4

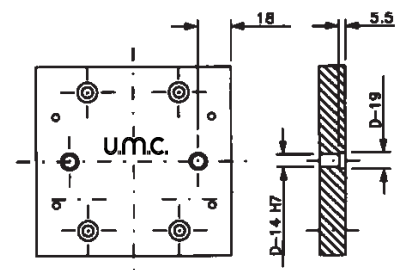
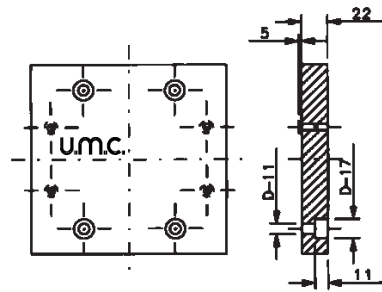

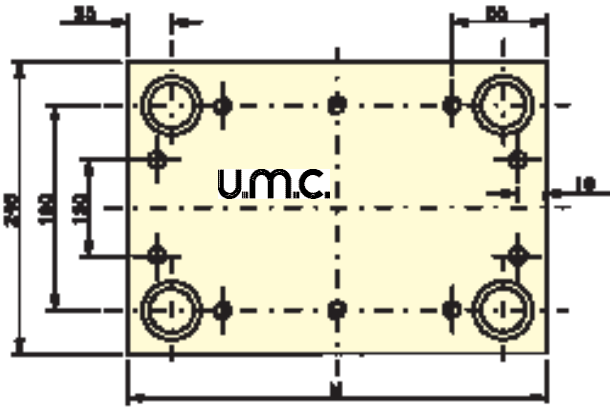

PS

L x M	S				N Fori Viti
246 x 246	26				4
246 x 296	26				4
246 x 346	26				6
246 x 396	26				6

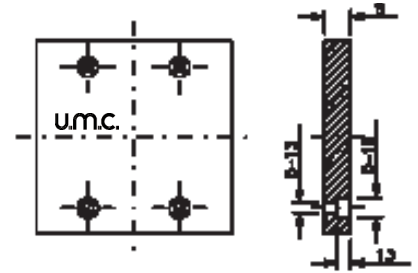

PSX

L x M	S				N Fori Viti
246 x 246	26	36	46	56	4
246 x 296	26	36	46	56	4
246 x 346	26	36	46	56	6
246 x 396	26	36	46	56	6

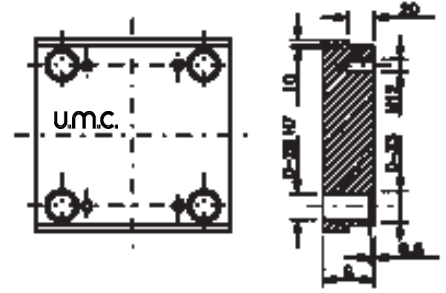

PSXE

L x M	S						N Fori Viti
246 x 246	46	56	66	76	96		4
246 x 296	46	56	66	76	96		4
246 x 346	46	56	66	76	96		6
246 x 396	46	56	66	76	96		6

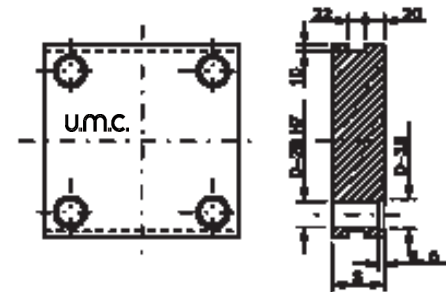

PI

L x M	S						N Fori Viti	
246 x 246	26	36	46	56	66	76	96	4
246 x 296	26	36	46	56	66	76	96	4
246 x 346	26	36	46	56	66	76	96	6
246 x 396	26	36	46	56	66	76	96	6

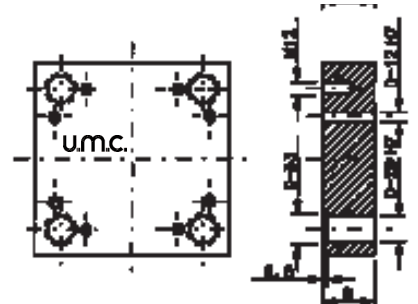

PM

L x M	S						N Fori Viti	
246 x 246	26	36	46	56	66	76	96	4
246 x 296	26	36	46	56	66	76	96	4
246 x 346	26	36	46	56	66	76	96	6
246 x 396	26	36	46	56	66	76	96	6

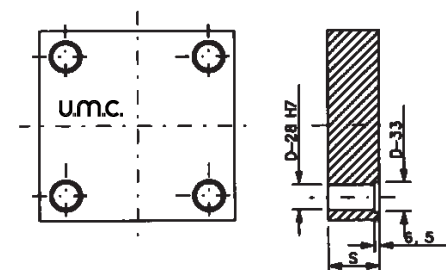

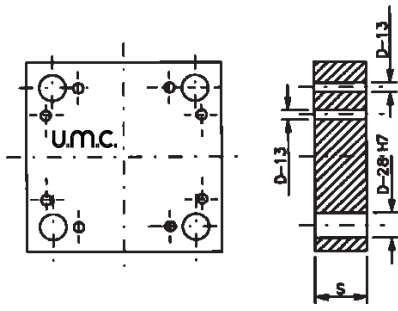

PX

L x M	S			N Fori Viti
246 x 246	36			4
246 x 296	36			4
246 x 346	36			6
246 x 396	36			6

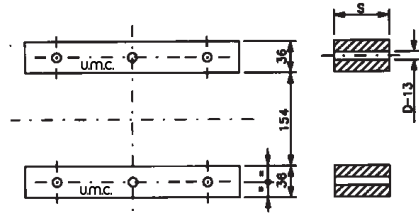

D

L x M	S			N Fori Viti
246 x 246	57	77	97	4
246 x 296	57	77	97	4
246 x 346	57	77	97	6
246 x 396	57	77	97	6

TE

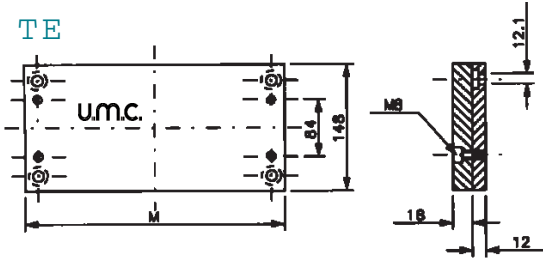

TEG

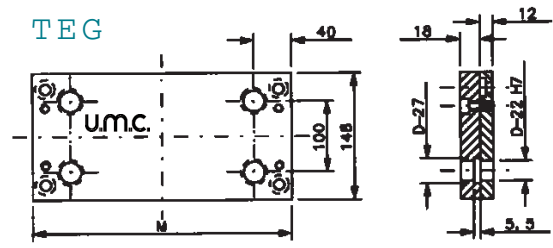

PF - PFG

L x M	N sedi viti
246 x 246	4
246 x 296	4
246 x 346	6
246 x 396	6

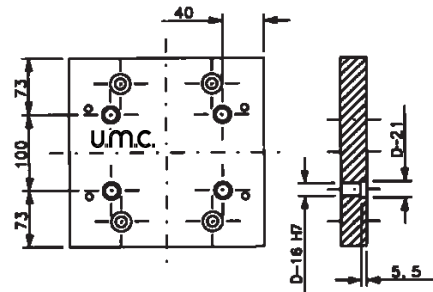
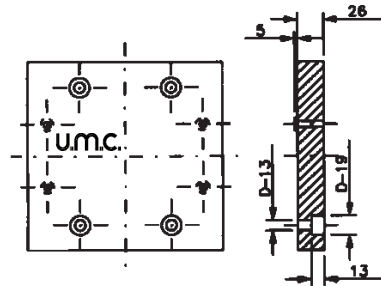

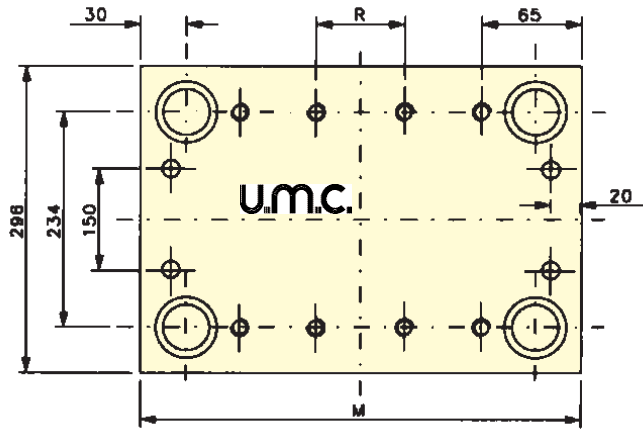

PS

L x M	S				R	N Fori Vfi
296 x 296	26				n	4
296 x 346	26				n	4
296 x 396	26				n	6
296 x 446	26				130	8

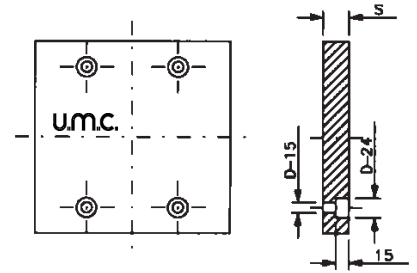

PSX

L x M	S						R	N Fori Vfi
296 x 296	36	46	56	66	76		n	4
296 x 346	36	46	56	66	76		n	6
296 x 396	36	46	56	66	76		n	6
296 x 446	36	46	56	66	76		130	8

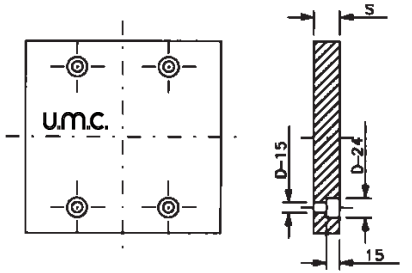

PSXE

L x M	S							
296 x 296	46	56	66	76	96	116		
296 x 346	46	56	66	76	96	116		
296 x 396	46	56	66	76	96	116		
296 x 446	46	56	66	76	96	116		

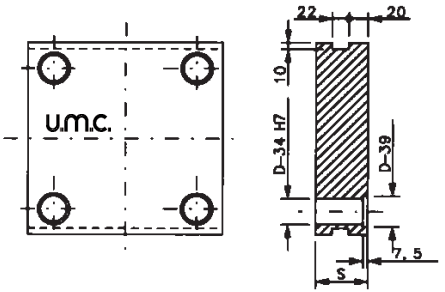

PI

L x M	S								R	N Fori Vfi
296 x 296	26	36	46	56	66	76	96	116	n	4
296 x 346	26	36	46	56	66	76	96	116	n	6
296 x 396	26	36	46	56	66	76	96	116	n	6
296 x 446	26	36	46	56	66	76	96	116	130	8

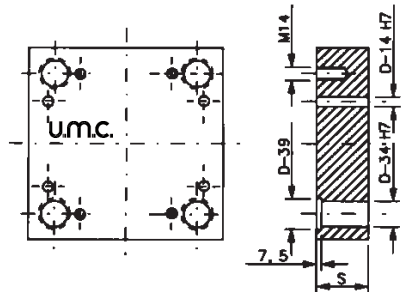

PM

L x M	S							
296 x 296	26	36	46	56	66	76	96	116
296 x 346	26	36	46	56	66	76	96	116
296 x 396	26	36	46	56	66	76	96	116
296 x 446	26	36	46	56	66	76	96	116

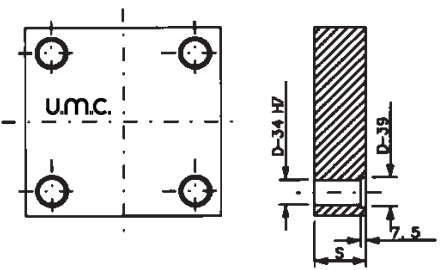

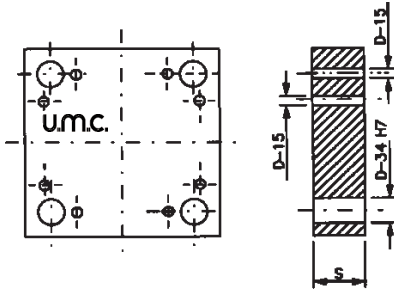

PX

L x M	S			R	N Fori Viti
296 x 296	36			n	4
296 x 346	36			n	6
296 x 396	36			n	6
296 x 446	36			130	8

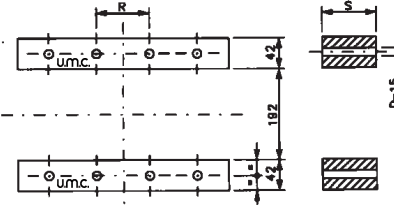

D

L x M	S			R	N Fori Viti
296 x 296	57	77	97	n	4
296 x 346	57	77	97	n	6
296 x 396	57	77	97	n	6
296 x 446	57	77	97	130	8

TE

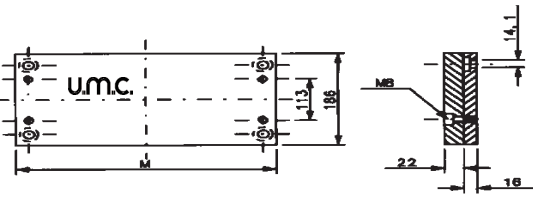

TEG

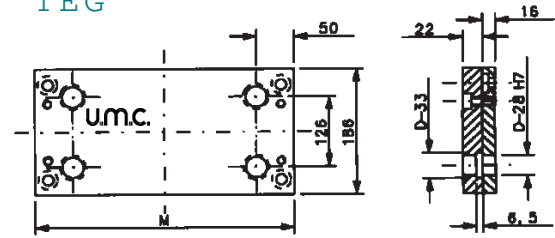

PF - PFG

L x M	R	N sedi viti
296 x 296	n	4
296 x 346	n	6
296 x 396	n	6
296 x 446	130	8

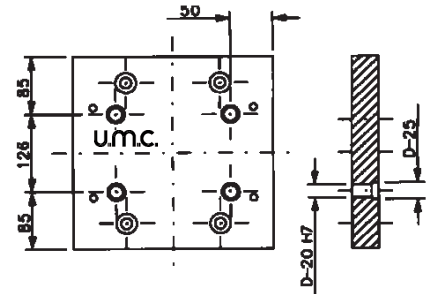
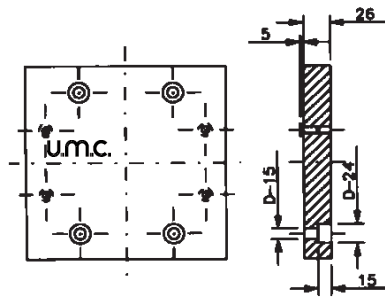

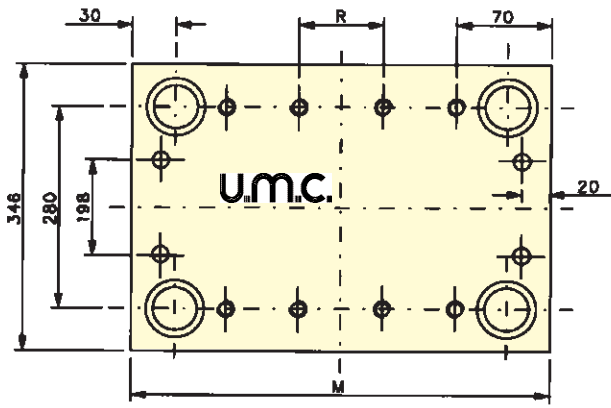

PS

L x M	S				R	N Fori Viti
346 x 346	26				n	6
346 x 396	26				n	6
346 x 446	26				130	8
346 x 496	26				150	8

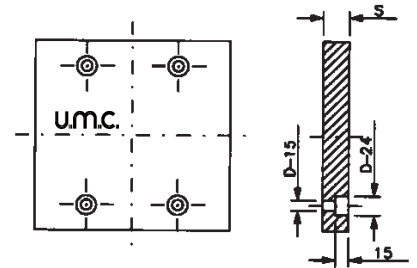

PSX

L x M	S						R	N Fori Viti
346 x 346	46	56	66	76	96		n	6
346 x 396	46	56	66	76	96		n	6
346 x 446	46	56	66	76	96		130	8
346 x 496	46	56	66	76	96		150	8

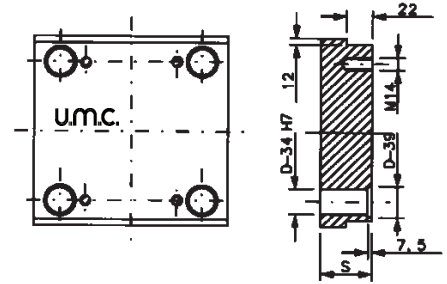

PSXE

L x M	S						R	N Fori Viti
346 x 346	56	66	76	96	116			
346 x 396	56	66	76	96	116			
346 x 446	56	66	76	96	116			
346 x 496	56	66	76	96	116			

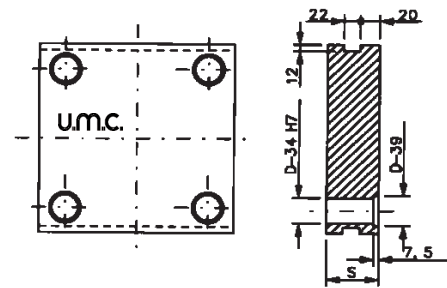

PI

L x M	S						R	N Fori Viti
346 x 346	46	56	66	76	96	116	n	6
346 x 396	46	56	66	76	96	116	n	6
346 x 446	46	56	66	76	96	116	130	8
346 x 496	46	56	66	76	96	116	150	8

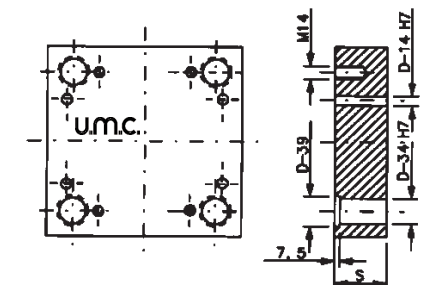

PM

L x M	S						R	N Fori Viti
346 x 346	26	36	46	56	66	76	96	116
346 x 396	26	36	46	56	66	76	96	116
346 x 446	26	36	46	56	66	76	96	116
346 x 496	26	36	46	56	66	76	96	116

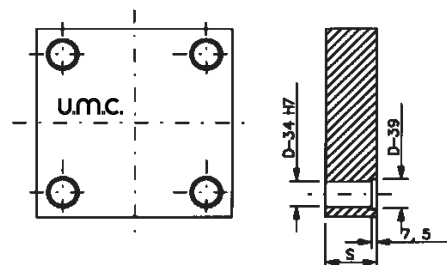

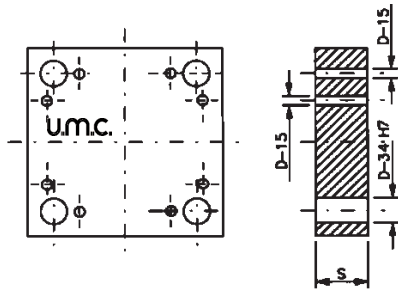

PX

L x M	S			R	N Fori Viti
346 x 346	46			n	6
346 x 396	46			n	6
346 x 446	46			130	8
346 x 496	46			150	8

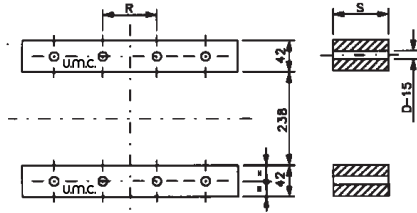

D

L x M	S			R	N Fori Viti
346 x 346	77	97	117	n	6
346 x 396	77	97	117	n	6
346 x 446	77	97	117	130	8
346 x 496	77	97	117	150	8

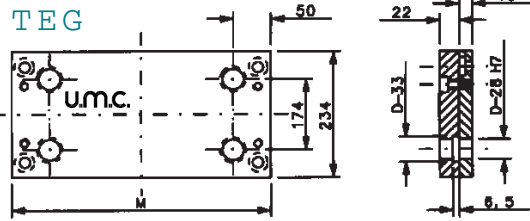
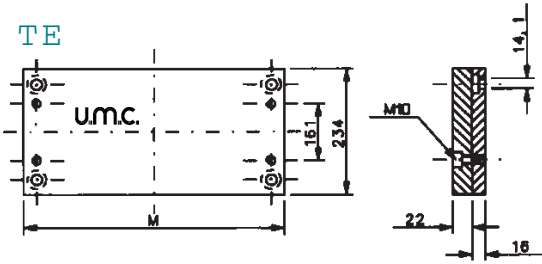

PF - PFG

L x M	R	N sedi viti
346 x 346	n	6
346 x 396	n	6
346 x 446	130	8
346 x 496	150	8

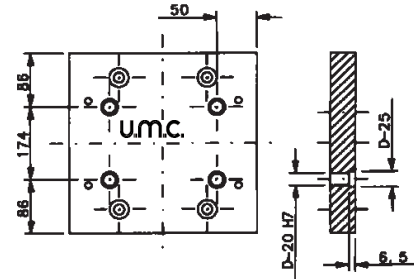
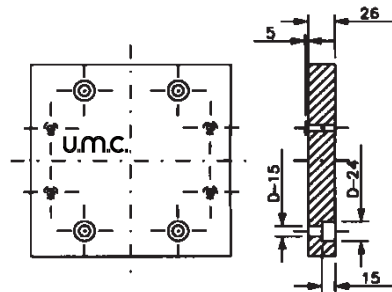

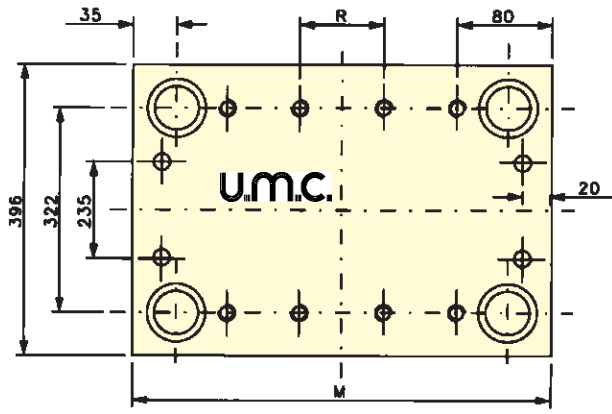

PS

L x M	S				R	N Fori Viti
396 x 396	26				n	6
396 x 446	26				130	8
396 x 496	26				150	8
396 x 546	26				150	8

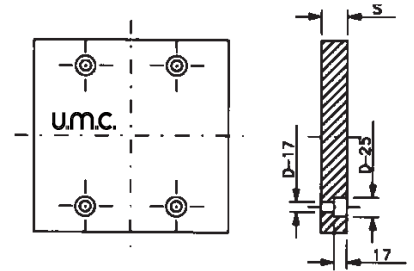

PSX

L x M	S								R	N Fori Viti
396 x 396	46	56	66	76	96	106			n	6
396 x 446	46	56	66	76	96	106			130	8
396 x 496	46	56	66	76	96	106			150	8
396 x 546	46	56	66	76	96	106			150	8

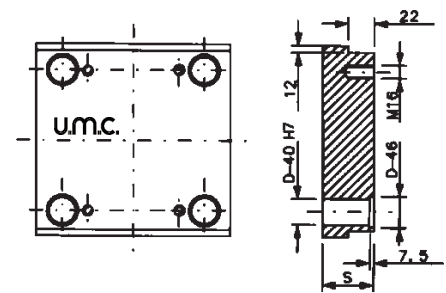

PSXE

L x M	S										
396 x 396	56	66	76	96	106	116	146				
396 x 446	56	66	76	96	106	116	146				
396 x 496	56	66	76	96	106	116	146				
396 x 546	56	66	76	96	106	116	146				

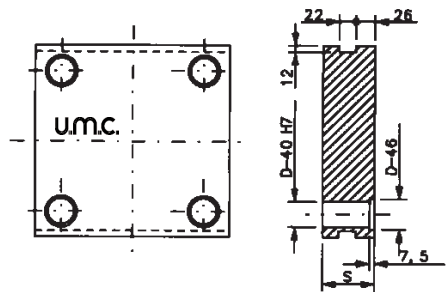

PI

L x M	S								R	N Fori Viti
396 x 396	46	56	66	76	96	106	116	146	n	6
396 x 446	46	56	66	76	96	106	116	146	130	8
396 x 496	46	56	66	76	96	106	116	146	150	8
396 x 546	46	56	66	76	96	106	116	146	150	8

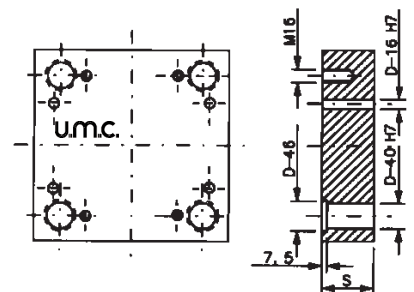

PM

L x M	S										
396 x 396	36	46	56	66	76	96	106				
396 x 446	36	46	56	66	76	96	106				
396 x 496	36	46	56	66	76	96	106				
396 x 546	36	46	56	66	76	96	106				

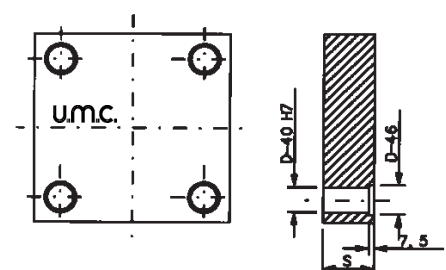

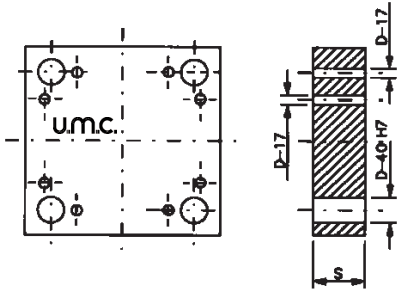

PX

L x M	S			R	N Fori Viti
396 x 396	46			n	6
396 x 446	46			130	8
396 x 496	46			150	8
396 x 546	46			150	8

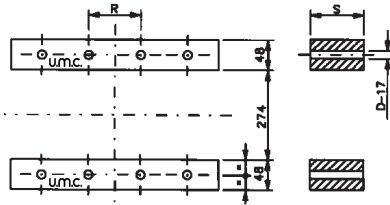

D

L x M	S			R	N Fori Viti
396 x 396	77	97	117	n	6
396 x 446	77	97	117	130	8
396 x 496	77	97	117	150	8
396 x 546	77	97	117	150	8

TE

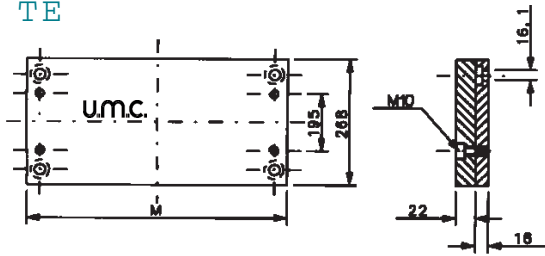

TEG

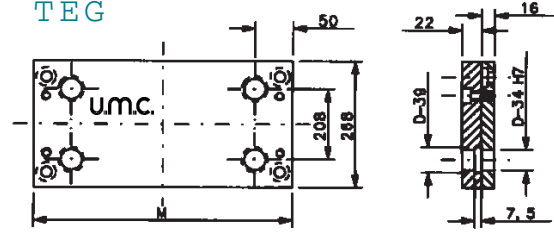

PF - PFG

L x M	R	N sedi viti
396 x 396	n	6
396 x 446	130	8
396 x 496	150	8
396 x 546	150	8

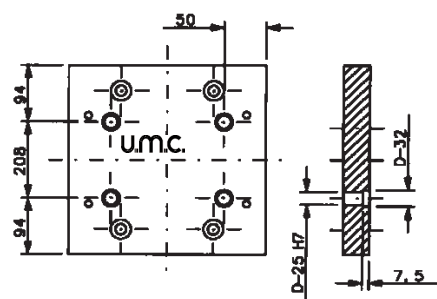
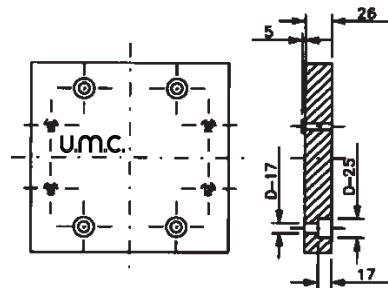

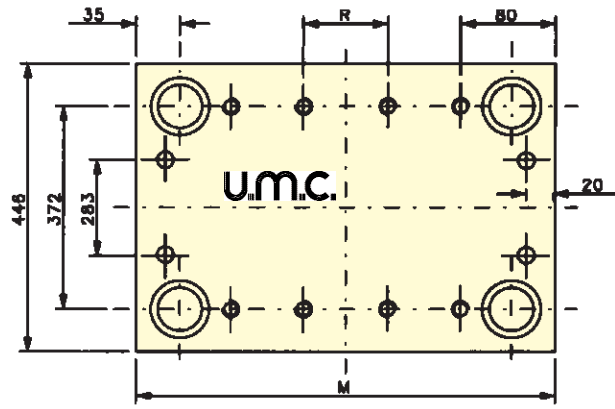

PS

L x M	S				R	N Fori Vfi
446 x 446	26				130	8
446 x 496	26				150	8
446 x 546	26				150	8
446 x 596	26				150	8

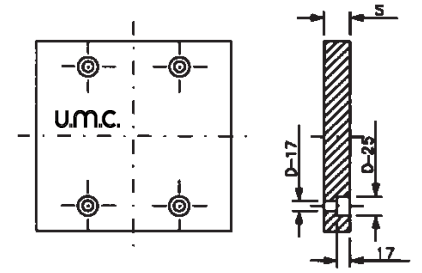

PSX

L x M	S								R	N Fori Vfi
446 x 446	46	56	66	76	96	106	116	146	130	8
446 x 496	46	56	66	76	96	106	116	146	150	8
446 x 546	46	56	66	76	96	106	116	146	150	8
446 x 596	46	56	66	76	96	106	116	146	150	8

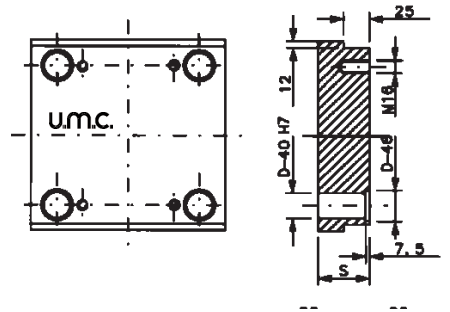

PSXE

L x M	S							
446 x 446	56	66	76	96	106	116	146	
446 x 496	56	66	76	96	106	116	146	
446 x 546	56	66	76	96	106	116	146	
446 x 596	56	66	76	96	106	116	146	

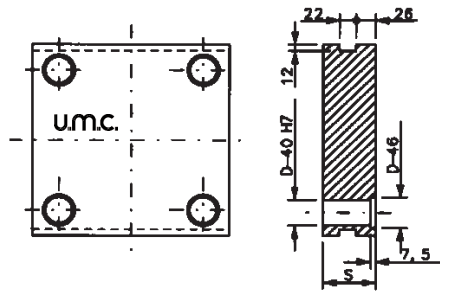

PI

L x M	S								R	N Fori Vfi
446 x 446	46	56	66	76	96	106	116	146	130	8
446 x 496	46	56	66	76	96	106	116	146	150	8
446 x 546	46	56	66	76	96	106	116	146	150	8
446 x 596	46	56	66	76	96	106	116	146	150	8

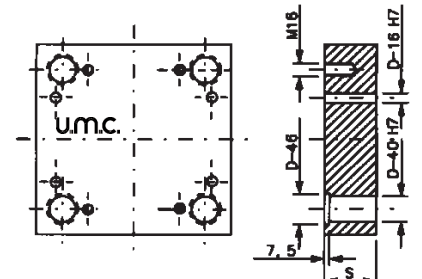

PM

L x M	S								
446 x 446	36	46	56	66	76	96	106	116	146
446 x 496	36	46	56	66	76	96	106	116	146
446 x 546	36	46	56	66	76	96	106	116	146
446 x 596	36	46	56	66	76	96	106	116	146

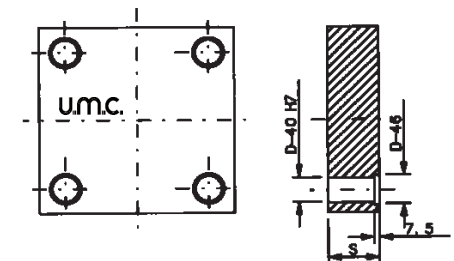

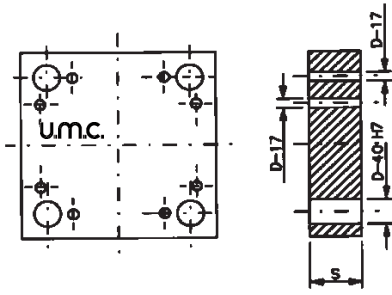

PX

L x M	S			R	N Fori Viti
446 x 446	46			130	8
446 x 496	46			150	8
446 x 546	46			150	8
446 x 596	46			150	8

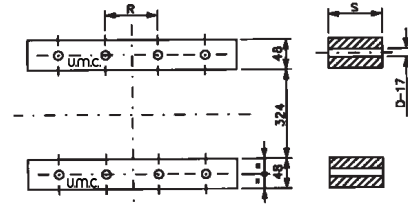

D

L x M	S			R	N Fori Viti
446 x 446	77	97	117	130	8
446 x 496	77	97	117	150	8
446 x 546	77	97	117	150	8
446 x 596	77	97	117	150	8

TE

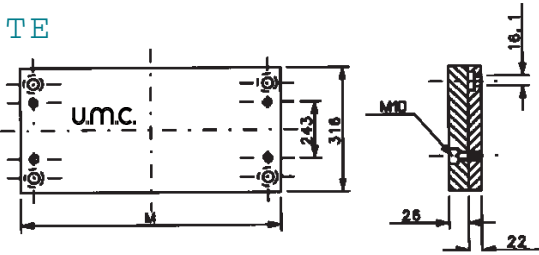

TEG

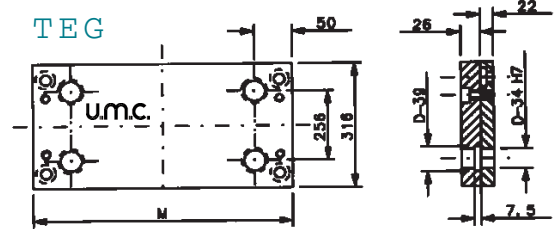

PF - PFG

L x M	R	N sedi viti
446 x 446	130	8
446 x 496	150	8
446 x 546	150	8
446 x 596	150	8

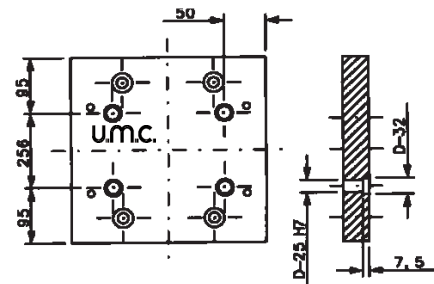
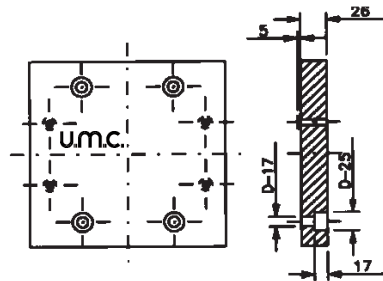

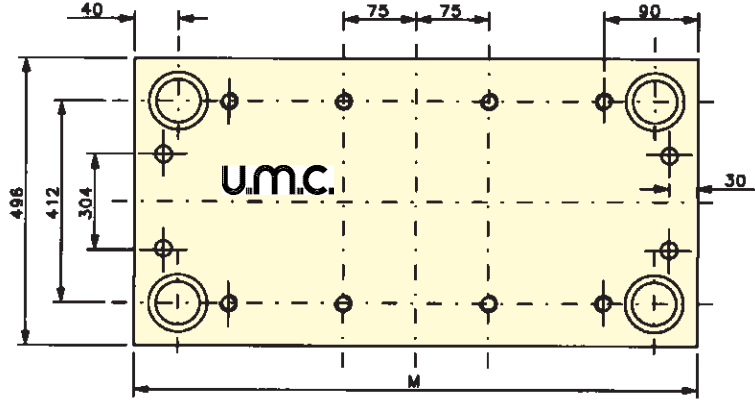

PS

L x M	S					N Fori Viti
496 x 496	36					6
496 x 546	36					6
496 x 596	36					8
496 x 646	36					8

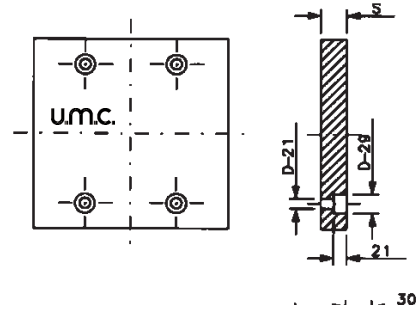

PSX

L x M	S					N Fori Viti
496 x 496	76	96	116	126	146	6
496 x 546	76	96	116	126	146	6
496 x 596	76	96	116	126	146	8
496 x 646	76	96	116	126	146	8

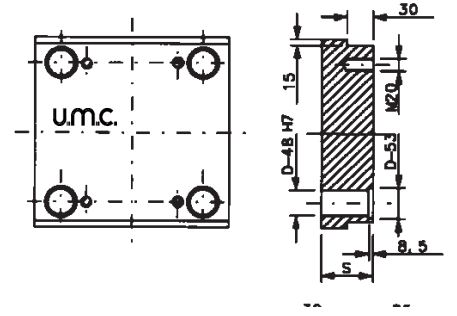

PSXE

L x M	S					N Fori Viti
496 x 496	76	96	116	126	146	
496 x 546	76	96	116	126	146	
496 x 596	76	96	116	126	146	
496 x 646	76	96	116	126	146	

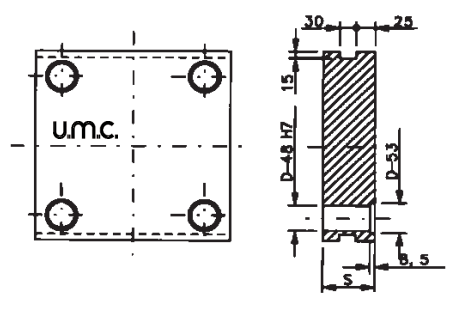

PI

L x M	S					N Fori Viti
496 x 496	76	96	116	126	146	6
496 x 546	76	96	116	126	146	6
496 x 596	76	96	116	126	146	8
496 x 646	76	96	116	126	146	8

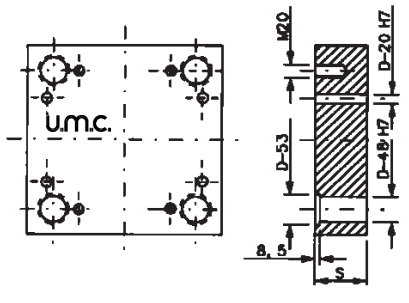

PM

L x M	S					N Fori Viti
496 x 496	76	96	116	126	146	
496 x 546	76	96	116	126	146	
496 x 596	76	96	116	126	146	
496 x 646	76	96	116	126	146	

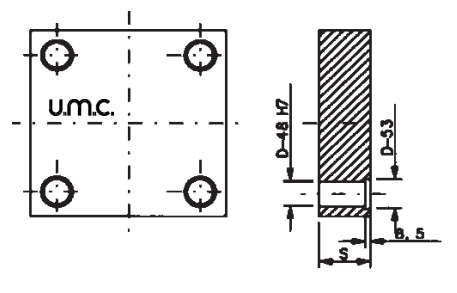

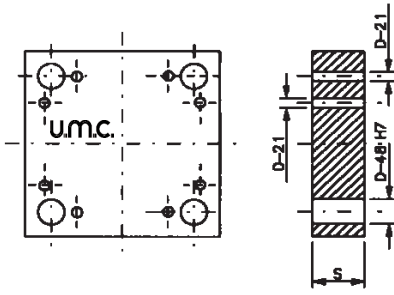

PX

L x M	S			N Fori Viti
496 x 496	46	56	66	6
496 x 546	46	56	66	6
496 x 596	46	56	66	8
496 x 646	46	56	66	8

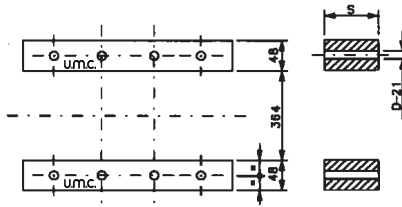

D

L x M	S			N Fori Viti
496 x 496	97	117	147	6
496 x 546	97	117	147	6
496 x 596	97	117	147	8
496 x 646	97	117	147	8

TE

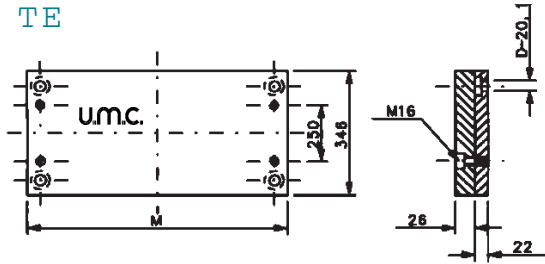

TEG

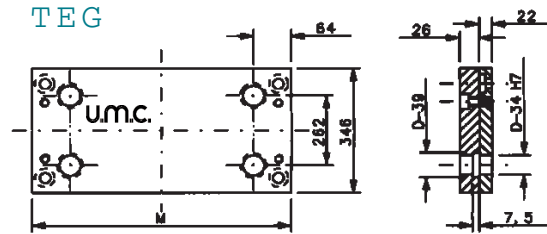

PF - PFG

L x M	N sedi viti
496 x 496	6
496 x 546	6
496 x 596	8
496 x 646	8

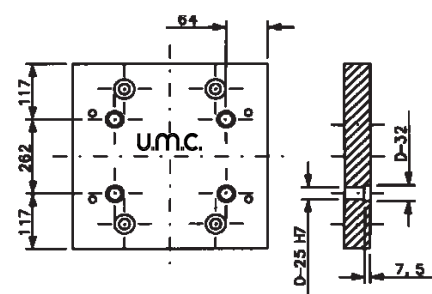
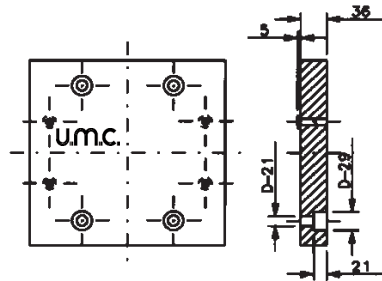

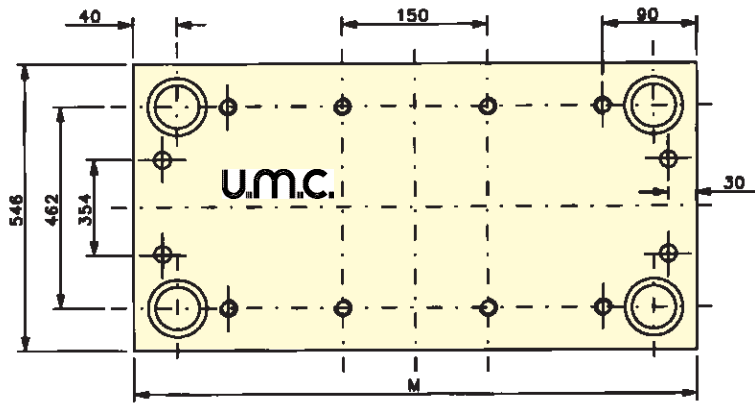

PS

L x M	S					N Fori Viti
546 x 546	36					6
546 x 596	36					8
546 x 646	36					8
546 x 696	36					8

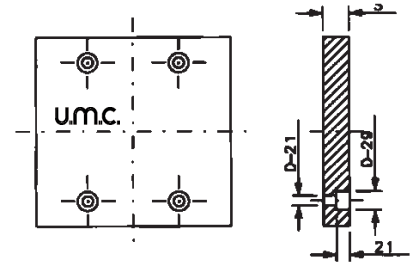

PSX

L x M	S					N Fori Viti
546 x 546	76	96	116	126	146	6
546 x 596	76	96	116	126	146	8
546 x 646	76	96	116	126	146	8
546 x 696	76	96	116	126	146	8

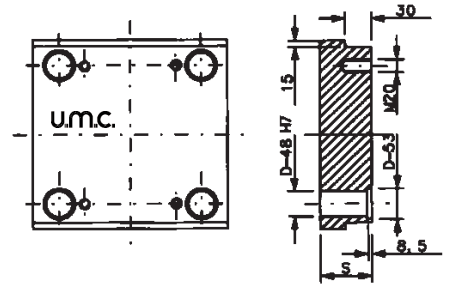

PSXE

L x M	S					N Fori Viti
546 x 546	76	96	116	126	146	6
546 x 596	76	96	116	126	146	8
546 x 646	76	96	116	126	146	8
546 x 696	76	96	116	126	146	8

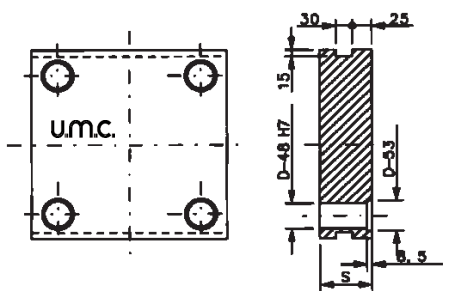

PI

L x M	S					N Fori Viti
546 x 546	76	96	116	126	146	6
546 x 596	76	96	116	126	146	8
546 x 646	76	96	116	126	146	8
546 x 696	76	96	116	126	146	8

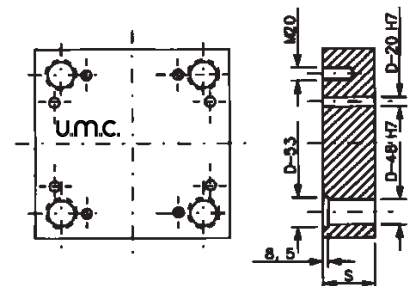

PM

L x M	S					N Fori Viti
546 x 546	76	96	116	126	146	6
546 x 596	76	96	116	126	146	8
546 x 646	76	96	116	126	146	8
546 x 696	76	96	116	126	146	8

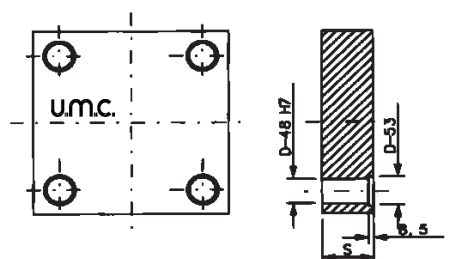

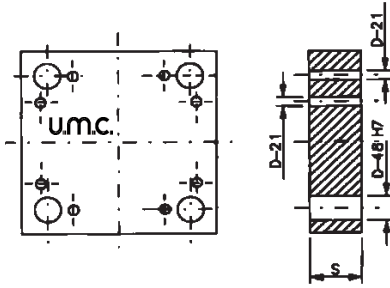

PX

L x M	S			N Fori Viti
	46	56	66	
546 x 546	46	56	66	6
546 x 596	46	56	66	8
546 x 646	46	56	66	8
546 x 696	46	56	66	8

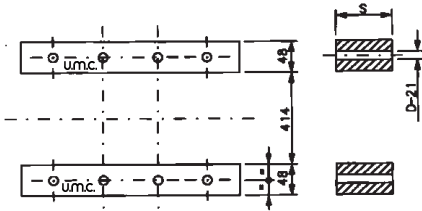

D

L x M	S			N Fori Viti
	97	117	147	
546 x 546	97	117	147	6
546 x 596	97	117	147	8
546 x 646	97	117	147	8
546 x 696	97	117	147	8

TE

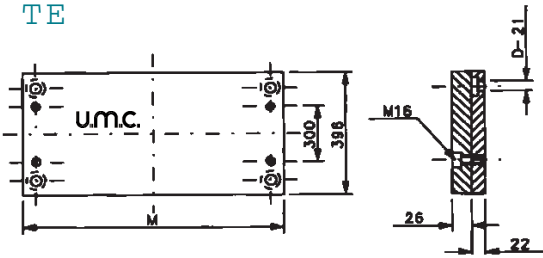

TEG

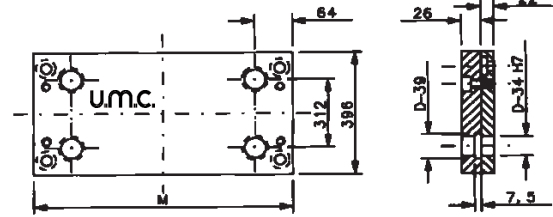

PF - PFG

L x M	N sedi viti
546 x 546	6
546 x 596	8
546 x 646	8
546 x 696	8

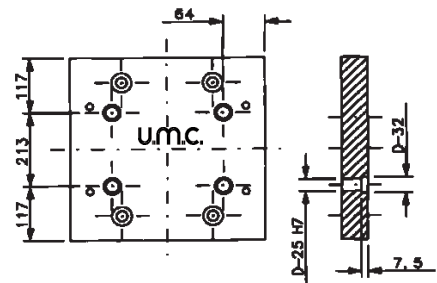
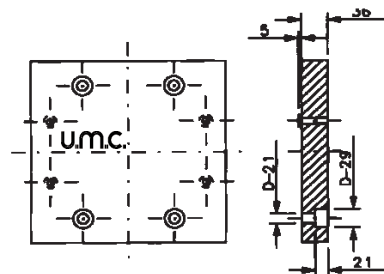

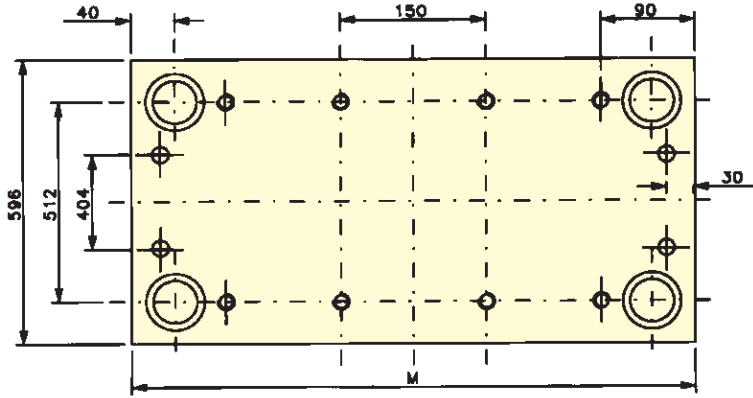

PS

L x M	S					N Fori Viti
596 x 596	36					8
596 x 646	36					8
596 x 696	36					8
596 x 746	36					8

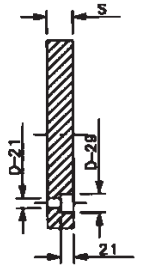
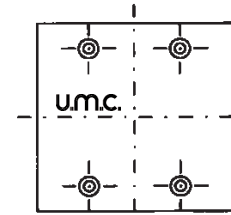

PSX

L x M	S					N Fori Viti
596 x 596	76	96	116	126	146	8
596 x 646	76	96	116	126	146	8
596 x 696	76	96	116	126	146	8
596 x 746	76	96	116	126	146	8

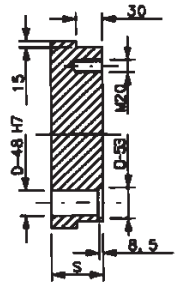
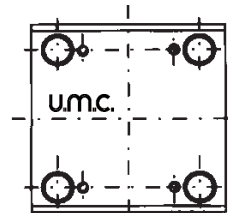

PSXE

L x M	S					N Fori Viti
596 x 596	76	96	116	126	146	8
596 x 646	76	96	116	126	146	8
596 x 696	76	96	116	126	146	8
596 x 746	76	96	116	126	146	8

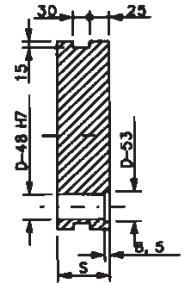
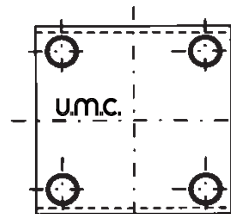

PI

L x M	S					N Fori Viti
596 x 596	76	96	116	126	146	8
596 x 646	76	96	116	126	146	8
596 x 696	76	96	116	126	146	8
596 x 746	76	96	116	126	146	8

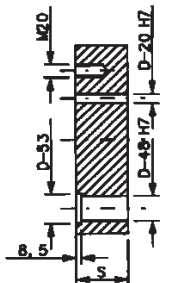
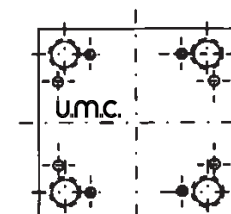

PM

L x M	S					N Fori Viti
596 x 596	76	96	116	126	146	8
596 x 646	76	96	116	126	146	8
596 x 696	76	96	116	126	146	8
596 x 746	76	96	116	126	146	8

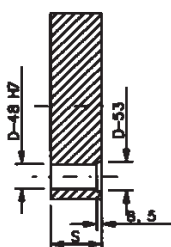
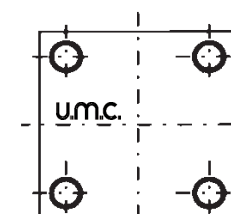

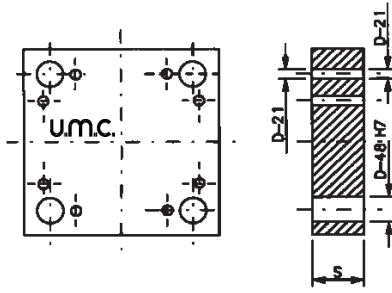

PX

L x M	S			N Fori Viti
596 x 596	46	56	66	8
596 x 646	46	56	66	8
596 x 696	46	56	66	8
596 x 746	46	56	66	8

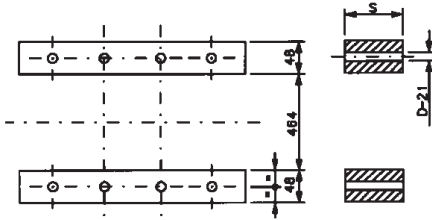

D

L x M	S			N Fori Viti
596 x 596	97	117	147	8
596 x 646	97	117	147	8
596 x 696	97	117	147	8
596 x 746	97	117	147	8

TE

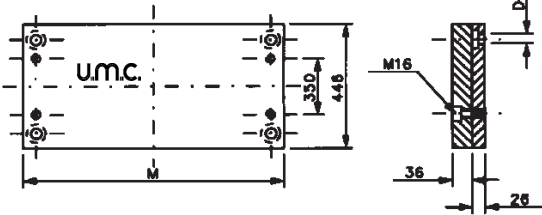

TEG

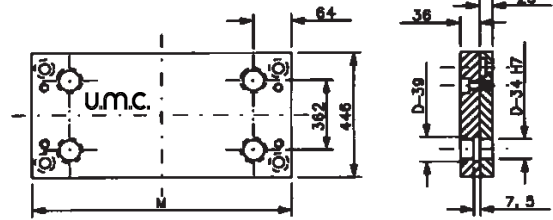

PF - PFG

L x M	N sedi viti
596 x 596	8
596 x 646	8
596 x 696	8
596 x 746	8

